

SKU:[PHO_0WZPLN1K]

LOT No.:DX-No.1

Jewelry cabinet table installation manual

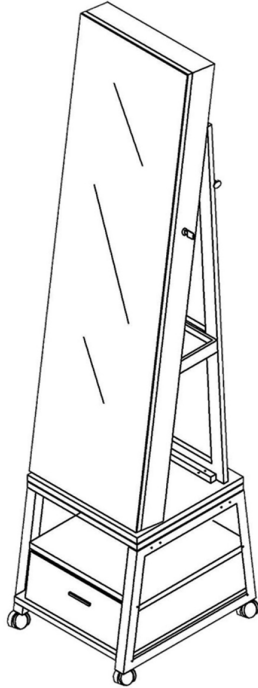

Trouble shooting:

Missing / Wrong / Broken parts and installation issues



Send email with your question, pic and order NO. to
support@idealhouse.vip



Respond within 24 hours



Issue resolved

IMPORTANT SAFETY INFORMATION

Please carefully read the instructions and caution warnings below before assembling the product. Following this guide will ensure that you install, use and maintain the product properly.

- Please keep this installation and user manual/instructions for future reference in case you need to assemble the product.
- Do not assemble if you notice serious damage such as cracks or bends.
- During installation, please use work gloves for hand safety.
- Please assemble the unit on carpeted floor or the flat cardboard box to avoid scratching the surface or your floor while assembling on the floor.
- To assemble, please use the complimentary installation tools (Allen Wrench). Pay more attention to the direction of components at each steps.
- It is recommended that two people work together to assemble the product.
- Please do not tighten the screws up too much, just to 80% before you finish to make the installation go on successfully.

RETURN POLICY

We believe you will absolutely love your new product. But for some reason you want to return your item, please contact us within 30 days after receiving and ensure that the product which you want to return is in a good condition in the original box with all original certificates of purchase, manuals and accessories attached.

HOW TO MAINTAIN YOUR PRODUCT:











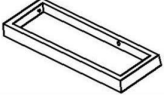

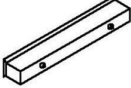

- Check the screws of the product are not loose from regular use.
- Do not use sharp instruments, rubbing alcohol, corrosive chemicals, or abrasive cleaners to clean the product.
- Do not keep the product in a damp environment for a long period of time. The damp environment may cause the iron components to rust and the plates to bulge and crack.



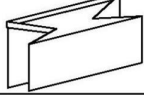
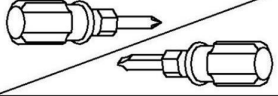

How to find us?

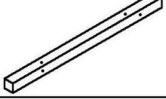
Customer Service

Email: support@idealhouse.vip

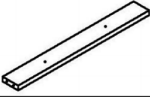
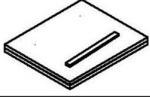

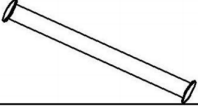
Paet List

A		1 Pcs	B		2 Pcs
C		1 Pcs	D		4 Pcs
E		1 Pcs	F		1 Pcs
G		2 Pcs	H		2 Pcs
			Long screw(4*20mm)		
I		16 Pcs	J		10 Pcs
Long screw(6*40mm)			Long screw(6*30mm)		
K		6 Pcs	L		1 Pcs
Long screw(3.5*12mm)					
M		1 Pcs	N		1 Pcs
Double head screwdriver(Cross & flat head)					
O		2 Pcs	P		1 Pcs
Long screw(320*370mm)			Long screw(320*18mm)		
Q		1 Pcs	R		1 Pcs
Long screw(340*338mm)			Long screw(370*338mm)		

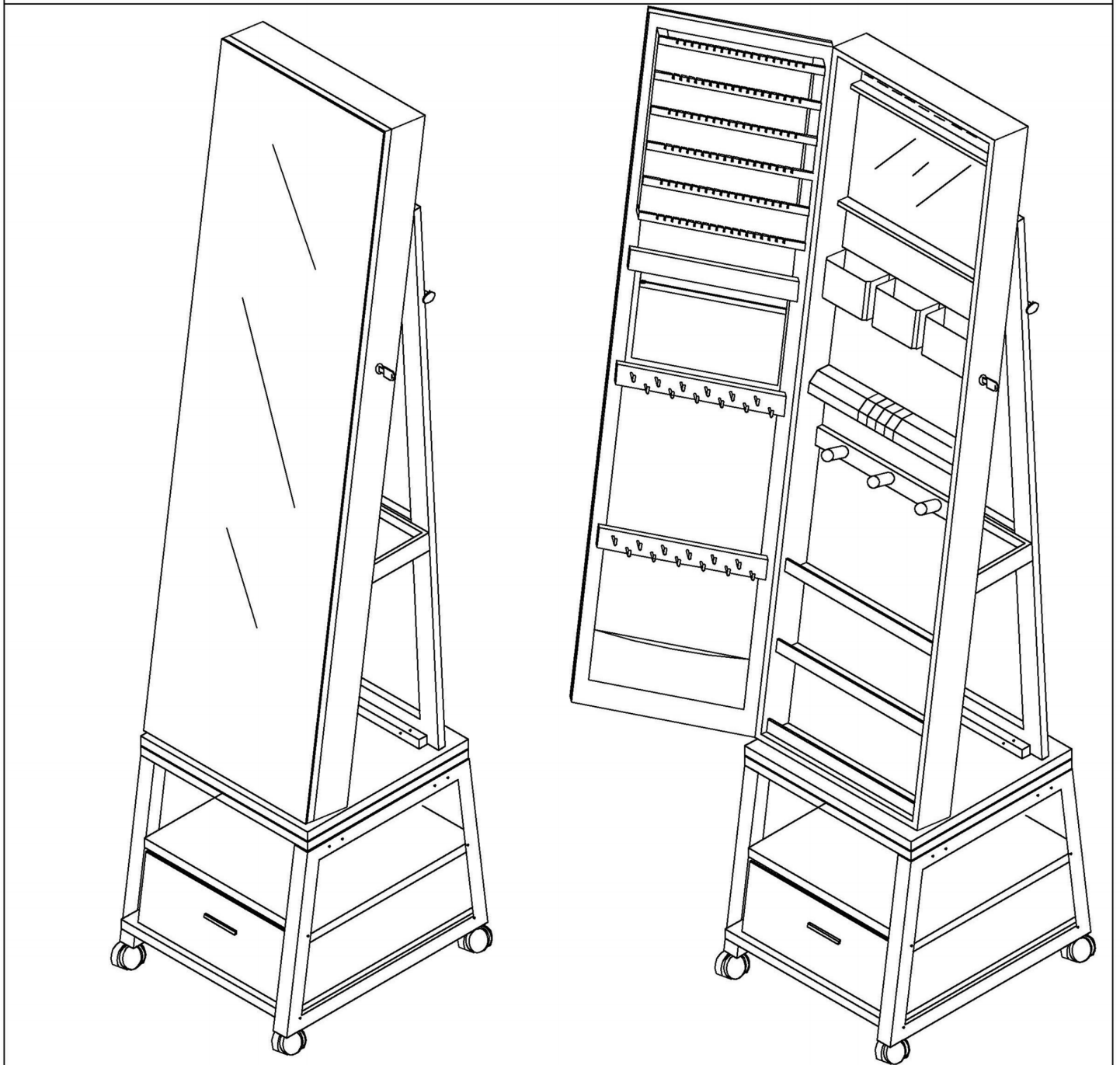
Ⓢ		2 Pcs	Ⓣ		1 Pcs
Long screw(338*40mm)			Long screw(380*320mm)		
Ⓤ		1 Pcs	Ⓥ		1 Pcs
Ⓦ		2 Pcs	Ⓧ		2 Pcs

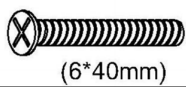
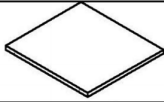
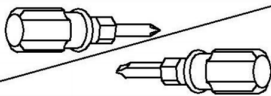

Step 1

I	 x 2	R	 x 1
M		O	 x 1

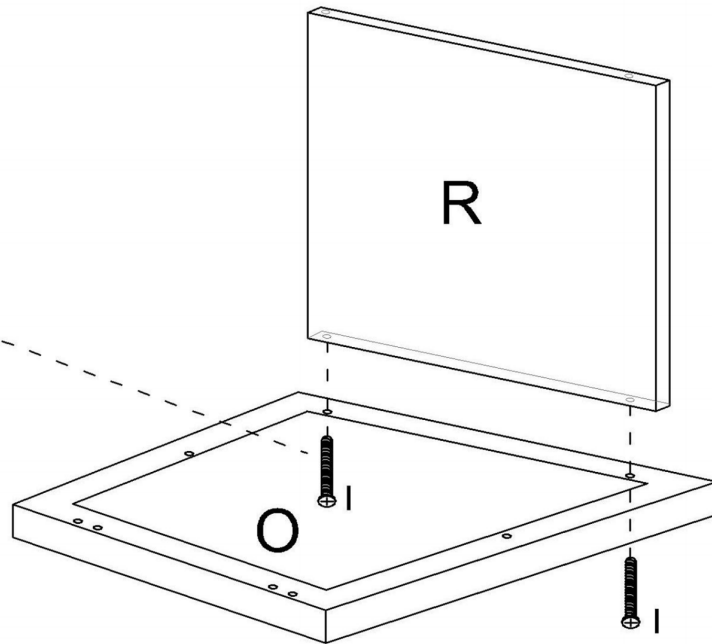
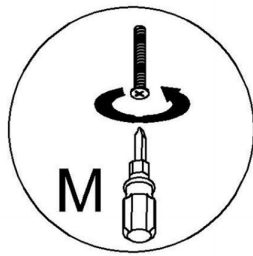

Step 2

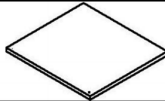
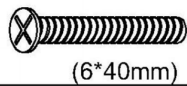
Q	 x 1
I	 x 2

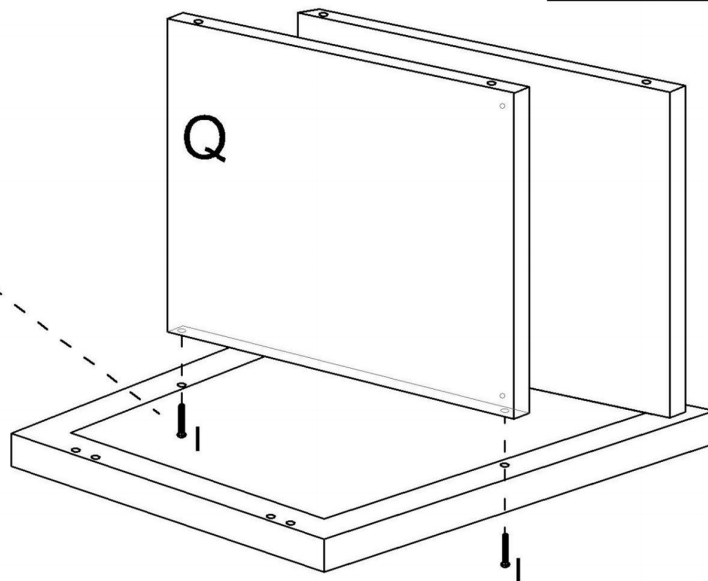
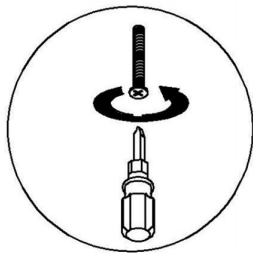

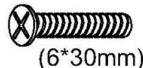
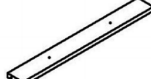

Step 3

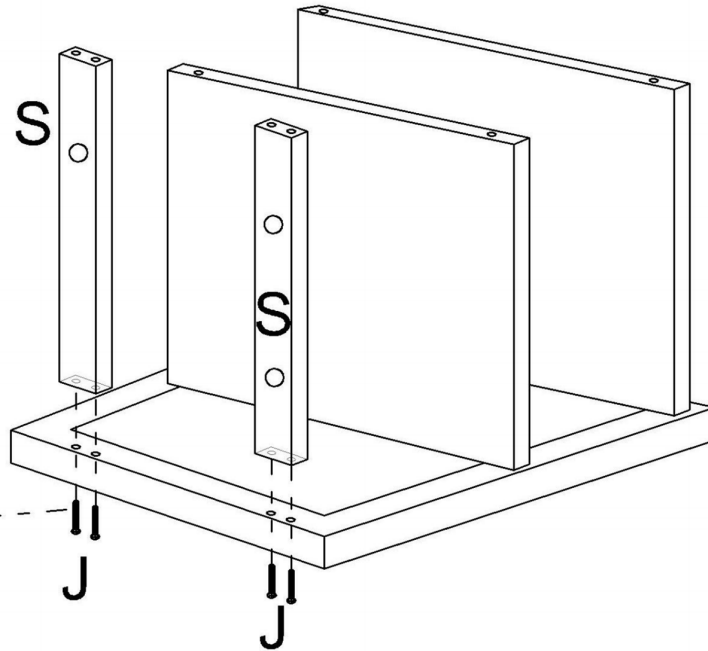
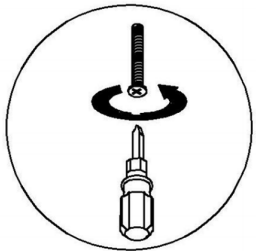
(J)	 (6*30mm)	x 4
(S)		x 1



Step 4

(I)	 (6*40mm)	x 4	(J)	 (6*30mm)	x 4
			(O)		x 1

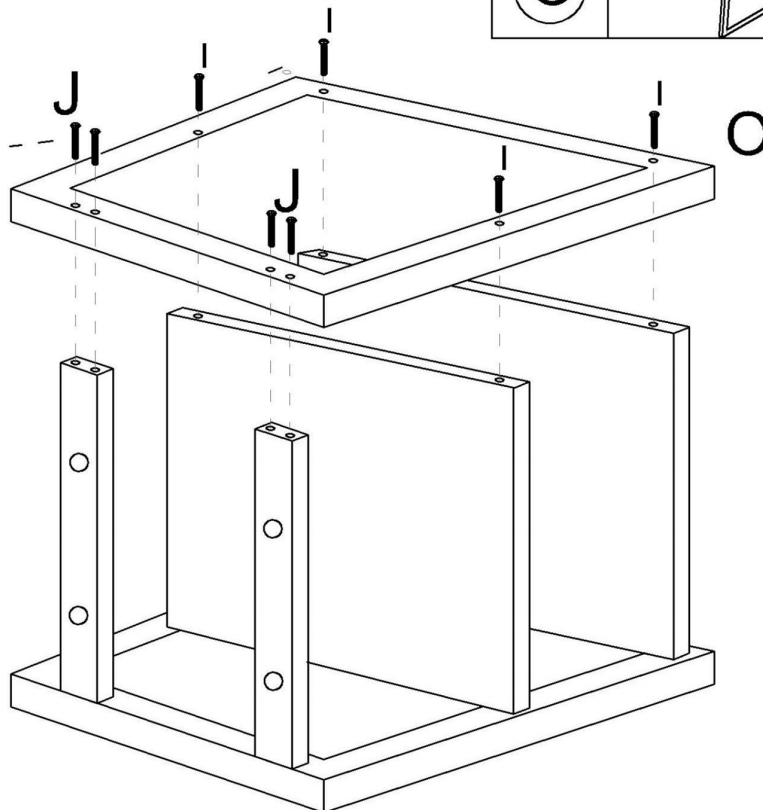
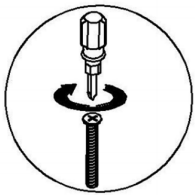

Step 5

(G)



x 2

(D)



x 4

(C)

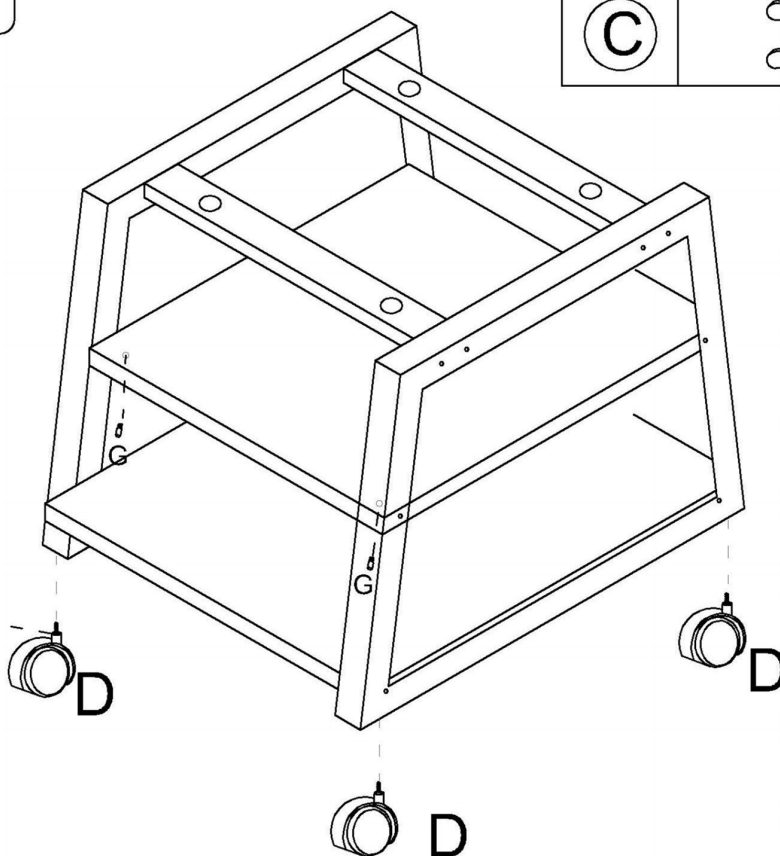
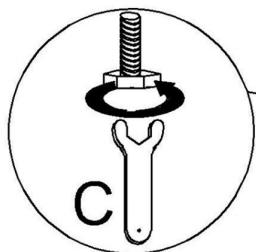
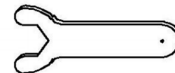

Step 6

(L)

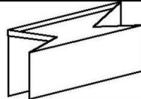

x 1

(I)

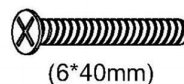

x 4

(6*40mm)

(E)

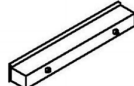

x 1

(T)

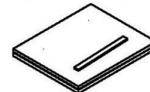

x 1

(H)

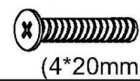

x 2

(4*20mm)

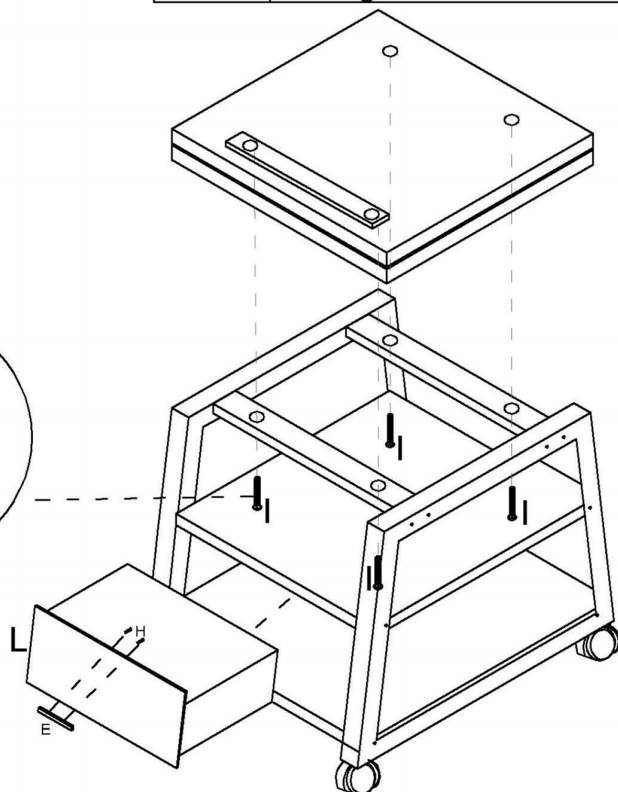
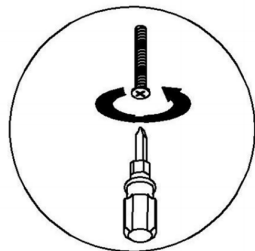

Step 7

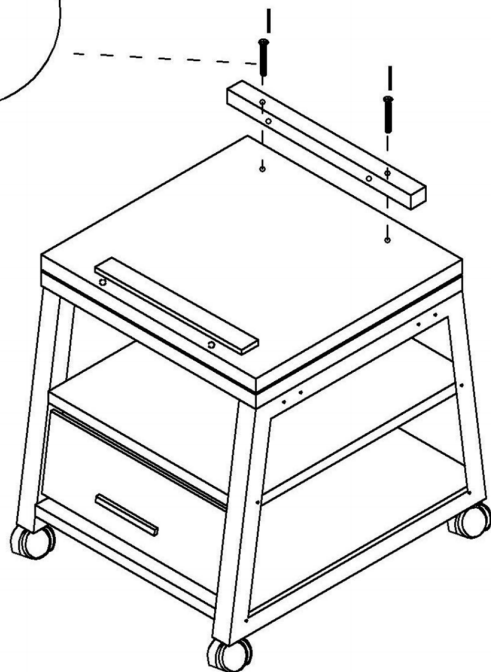
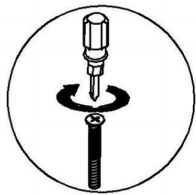

I

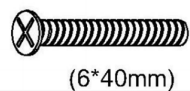

x 2

(6*40mm)

P

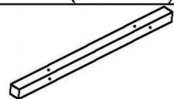

x 1

Step 8

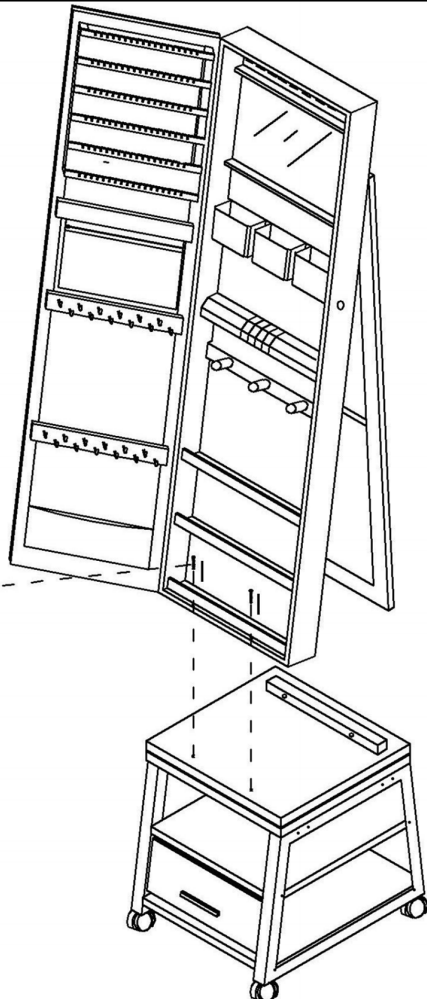
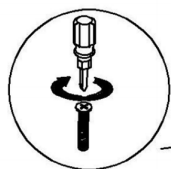

I

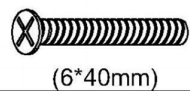

x 2

(6*40mm)







U

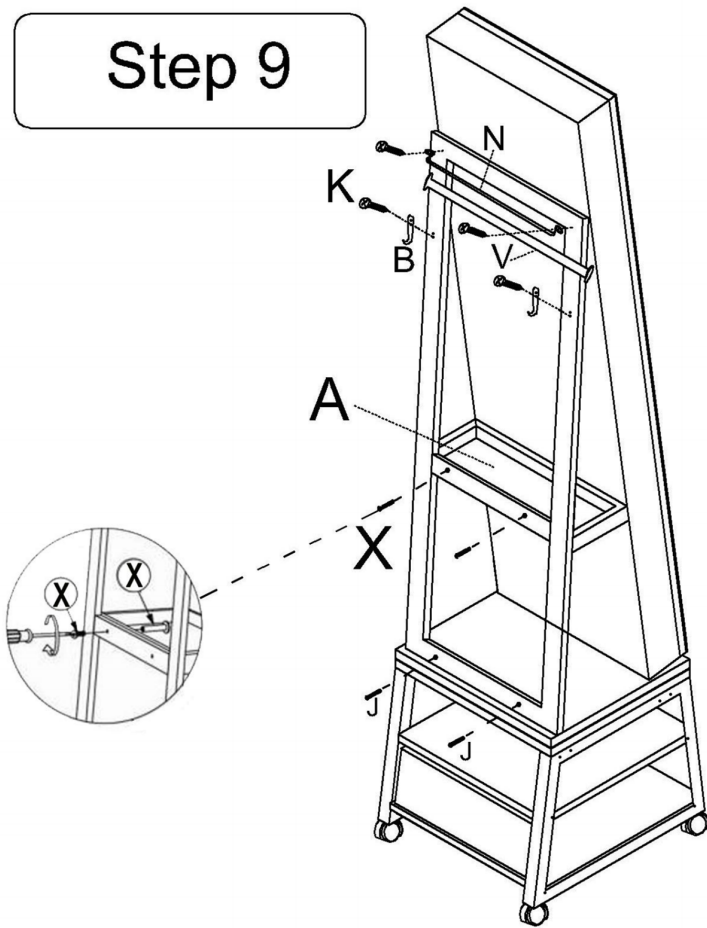

x 1

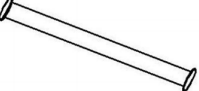
Step 9

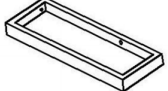
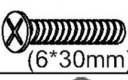

(K)		x 6
(B)		x 2
(V)		x 1
(N)		x 1
(A)		x 1
(J)	 6*30mm	x 2
(X)		x 2

Step 10

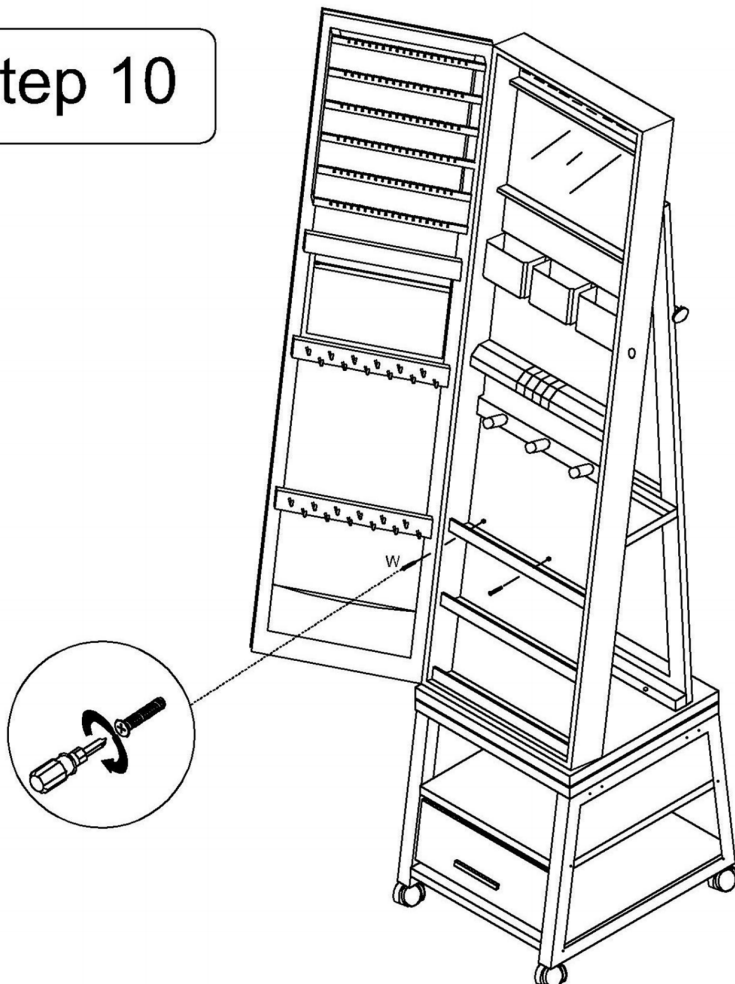

(W)		x 2
-----	---	-----