

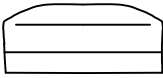

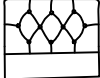

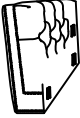
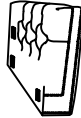

ASSEMBLY INSTRUCTION

CHAIR

| | | | | |
|---|---|---|---|---|
| A Seat | B Back | C Left Panel | D Right Panel | E Leg |
|  |  |  |  |  |
| 1 pc | 1 pc | 1 pc | 1 pc | 4 pcs |
| F Bolt 5/16"*75mm | G Flat Washer 5/16" | H Lock Washer 5/16" | I Allen Wrench 5/16" | |
|  |  |  |  | |
| 4 pcs | 4 pcs | 4 pcs | 1 pc | |

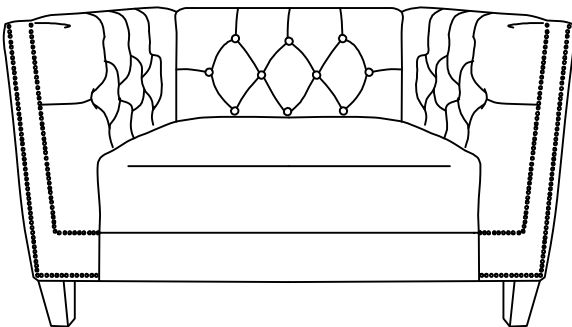

This page lists all the contents included in the box. Please take the time to identify the hardware as well as the individual components to this product. As you unpack and prepare for assembly, place the contents on a carpeted or padded area to protect them from damage.

1 Hook on Left Panel (C) & Right Panel (D) to Seat (A) properly.

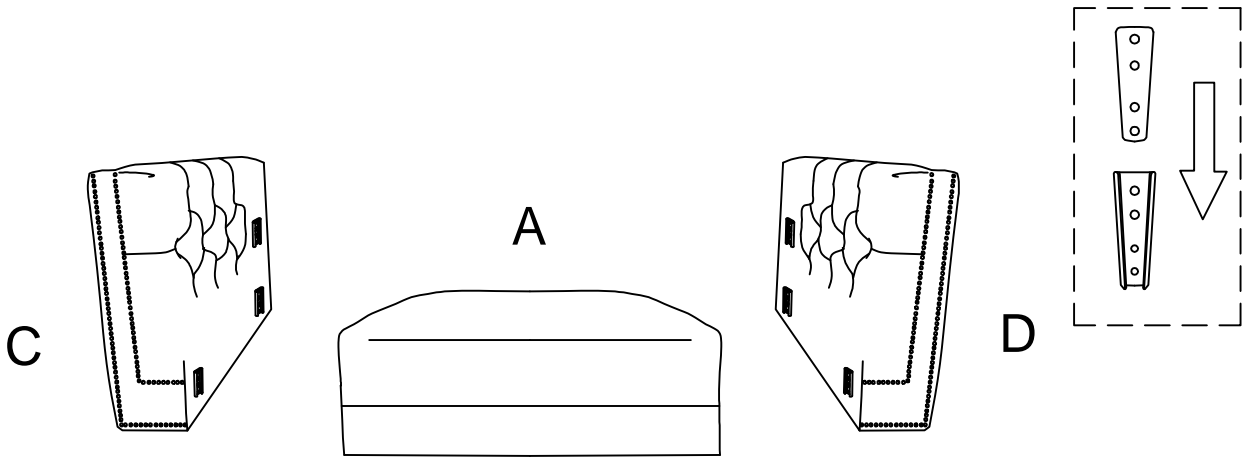

2 Hook on the Back (B) to Left Panel (C) & Right Panel (D) properly.

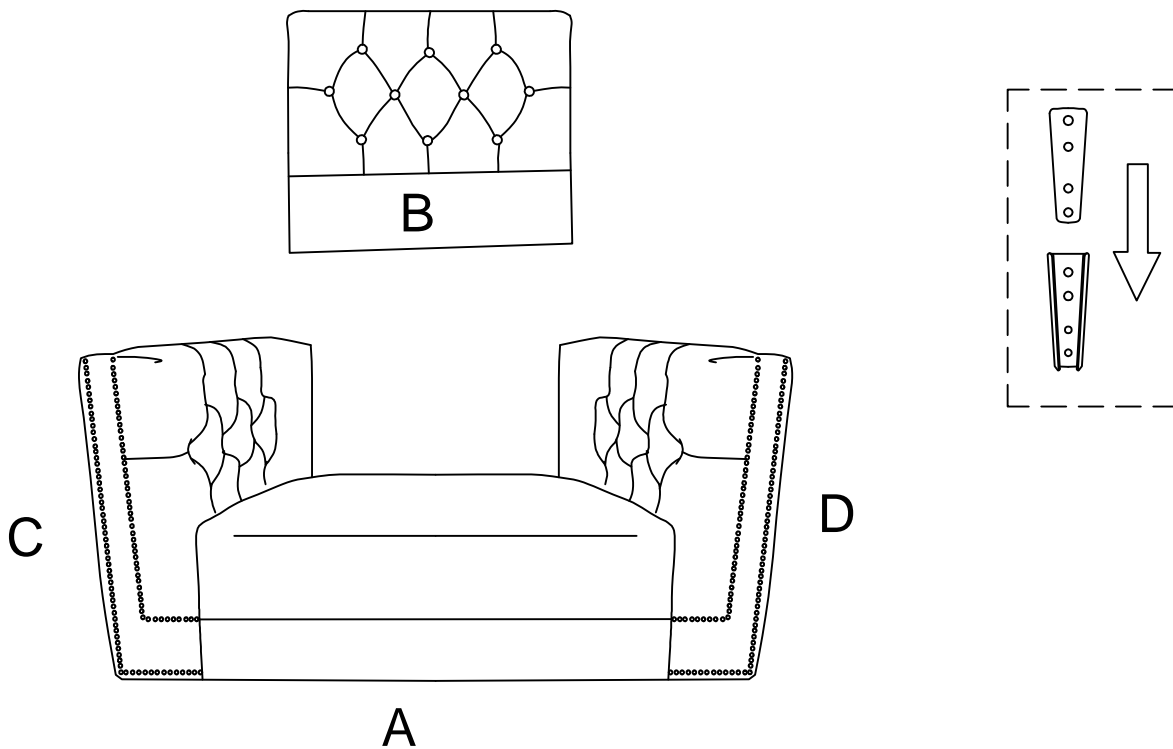

- 3** Assemble the Legs (E) to Left Panel (C) & Right Panel (D) using Bolt (F), Lock Washer (H) and Flat Washer (G) on both of holes. Turn the Allen Wrench (I) in Bolt (F).

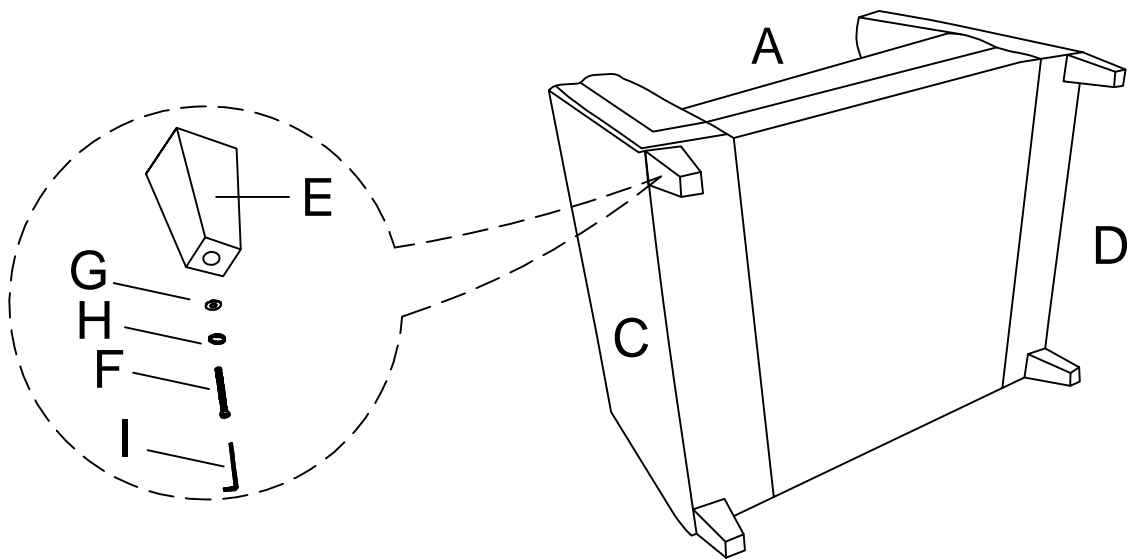

Cleaning & Care

Treat surface with care. Surface is resistant to scratches but is not scratch resistant. Clean surfaces with a dry or damp soft cloth. Do not use abrasive cleaners. Hardware may loosen over time. Periodically check that all connections are tight.