

# Metal Garden Shed

## OWNER'S MANUAL

Size 9 Ft X 6 Ft

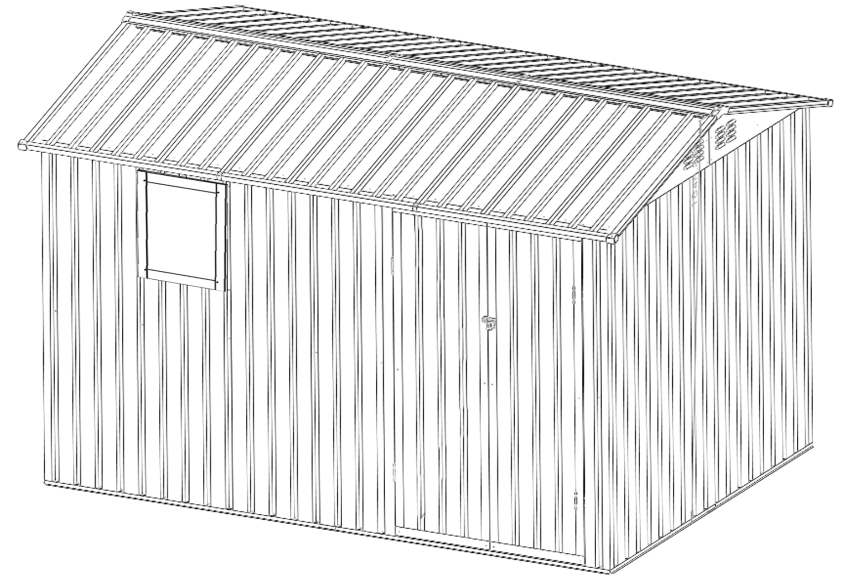
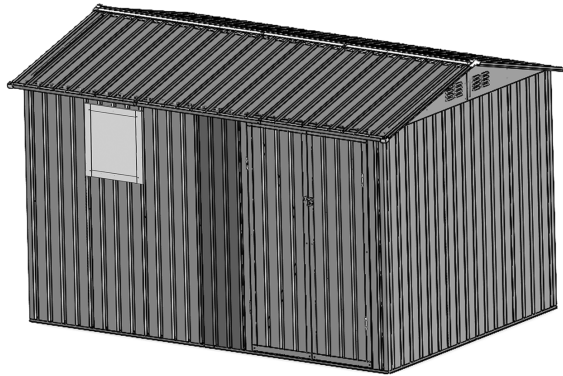

Tall walk in Shed

Quick & Easy Assembly

Ridge Reinforced walls

Wide Double Doors

Available in Various Sizes

Take care of sharp edges;

Please wear gloves;

It will take 2 people 6 - 7 hours to install.

# exploded view

First, open the package and check the list on the first page to make sure all accessories are included. If you find any missing accessories, please contact us immediately and we will replace them as soon as possible.

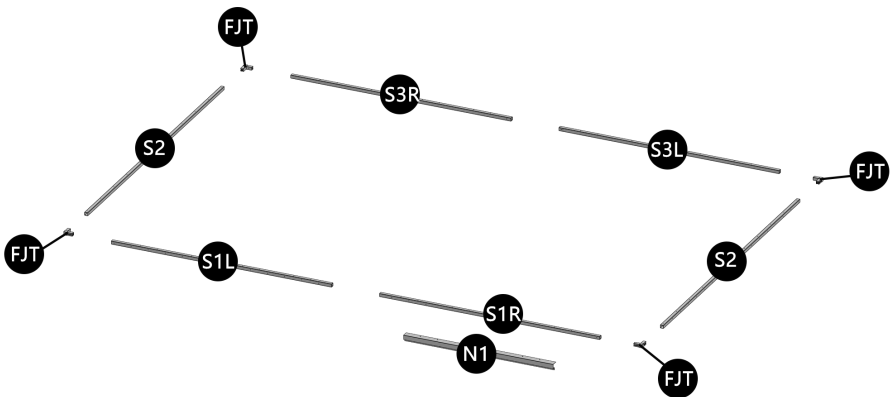
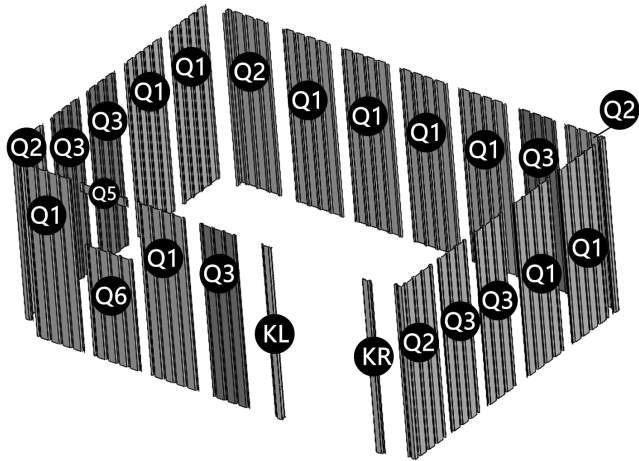
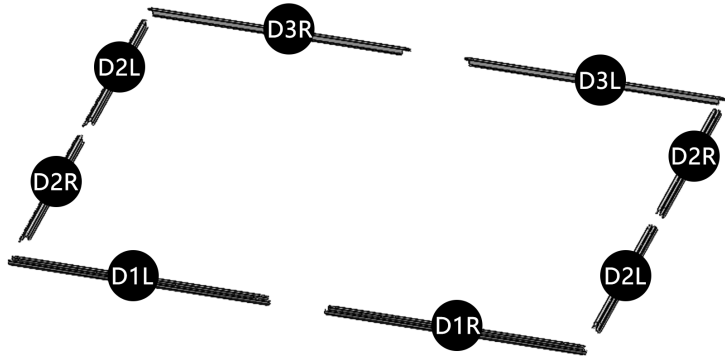



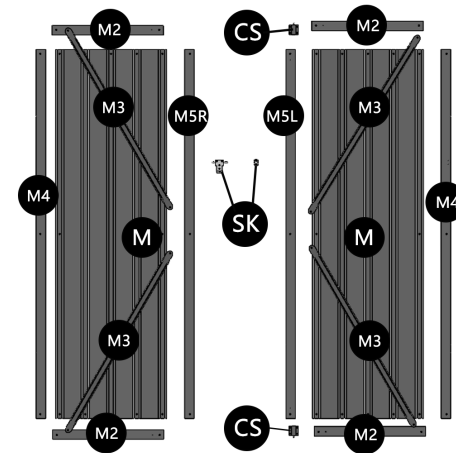
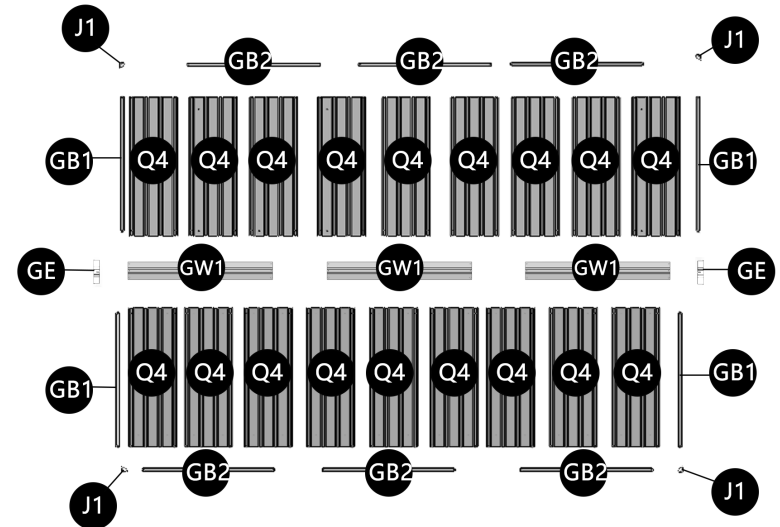
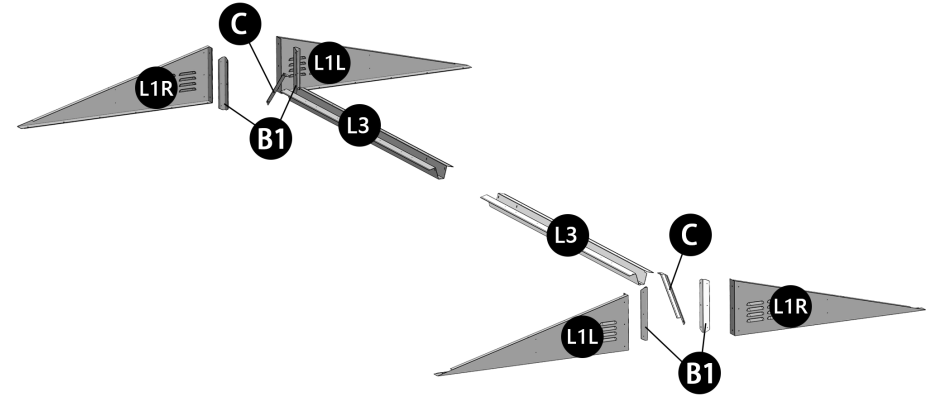

















# exploded view



















Inside the door

# Bundled Content











1. Please carefully check all accessories and remove them from the box to ensure that everything is intact. 2. If you find any missing parts, please do not use the product until the missing parts are replaced.



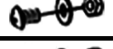

NO.	PART	QTY
D1L		1
D1R		1
D2L		2
D2R		2
D3L		1
D3R		1
S1L		1
S1R		1
S2		2
S3L		1
S3R		1
Q1		10
Q2		4
Q3		6
Q4		18
Q5		1
Q6		1
L1L		2
L1R		2
L3		2
GB1		4

NO.	PART	QTY
GB2		6
GW1		3
M		2
M2		4
M3		4
M4		2
M5L		1
M5R		1
KL		1
KR		1
W1		1
W2		2
W3		2
W4		2
C		2
N1		1
B1		4

# Bundled Content

1. Please carefully check all accessories and remove them from the box to ensure that everything is intact. 2. If you find any missing parts, please do not use the product until the missing parts are replaced.

NO.	PART	QTY
GE		2
HY		4
FJT		4
J1		4
SK		1
CS		2
F1		300
F3		12
F4		10
F14		
LSM		

NO.	PART	QTY
F8		8
F9		4
F10		20
F11		22

This component is only compatible with F1, F3, and F11. It is located in the external tool room and is easy to seal and waterproof.

Install LSM at screw exposure, Prevent collisions.

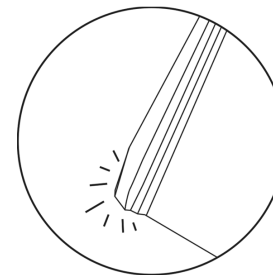

If there is slight bending on the corners

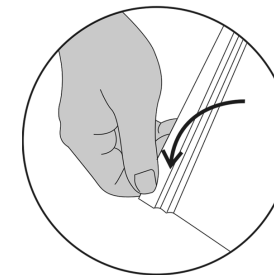

Pls wear gloves and stretch the corners slightly until they are flat

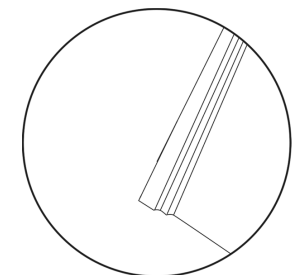

Then the sheets will be normal and there is no effect to the assembling

# About Assembly

## General steps:

Please read these instructions carefully before the assembly begins, and fully understand the assembly method and related details. Open the carton and carefully check the instructions and diagrams to confirm all the parts.

## Preparation for installation:

The location of the cottage must be level. If the surface is uneven, the part holes may be misaligned. Make sure the carport is properly secured.

## Recommended Tools:



gloves



Electric drill



Safety Helmet Hat



goggles







Phillips screwdriver

## Safety Precautions :

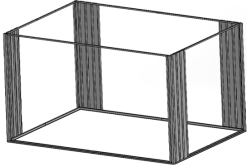
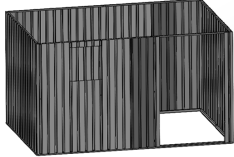
Parts may have sharp edges. Please wear gloves when handling these items and safety glasses when punching holes. Safety shoes are recommended. Please do not build and install in a windy environment. Make sure to be firmly anchored to solid ground immediately after construction is complete.

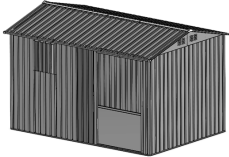
# DIRECTORY

<b>01</b>	<b>Foundation installation</b>		.....	1
<b>02</b>	<b>Upper frame installation</b>		.....	4
<b>03</b>	<b>Wall panel door frame installation</b>		.....	8
<b>04</b>	<b>Roof Tile Support Installation</b>		.....	11
<b>05</b>	<b>Installation of ridge tiles and edging</b>		.....	14
<b>06</b>	<b>Installation of doors and windows</b>		.....	20

## Assembly Method:

---

Unit: mm

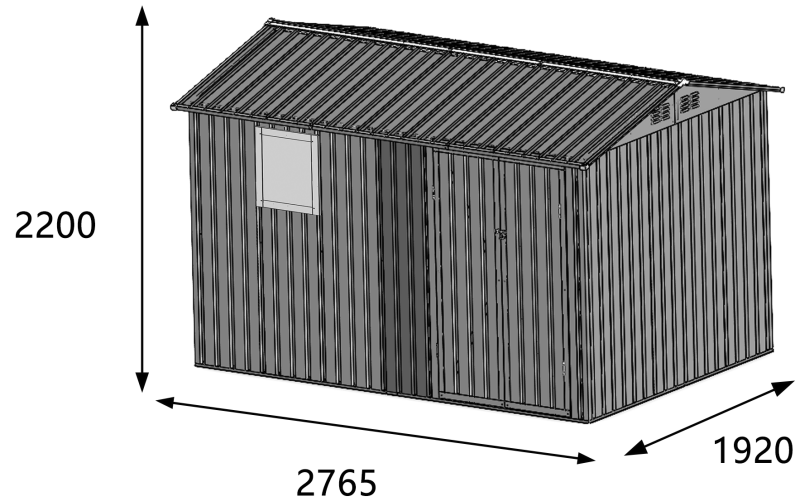

## 1.Foundation installation

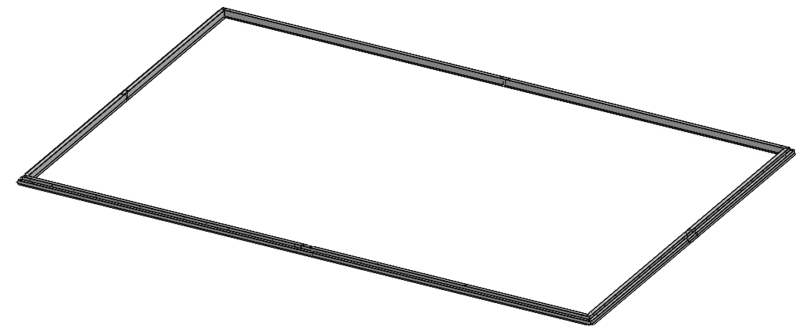

The installation space should be flat, and at least 3800x2000mm. The foundation is fixed on the ground in this space.

**Assembly Method:** In order to distinguish the orientation of the part, pay attention to the position of the hole in the example drawing

NO.	Part	QTY
D1L		1
D2R		2
F1		24

NO.	Part	QTY
D1R		1
D3L		1

NO.	Part	QTY
D2L		2
D3R		1

**step1**

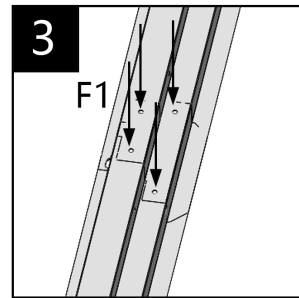
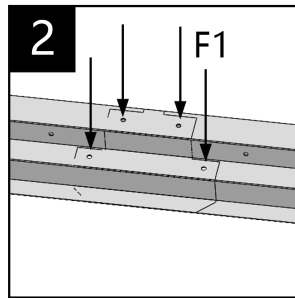
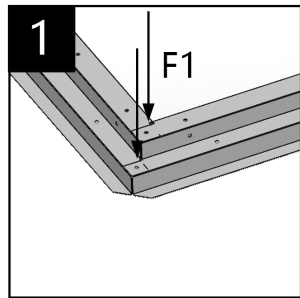
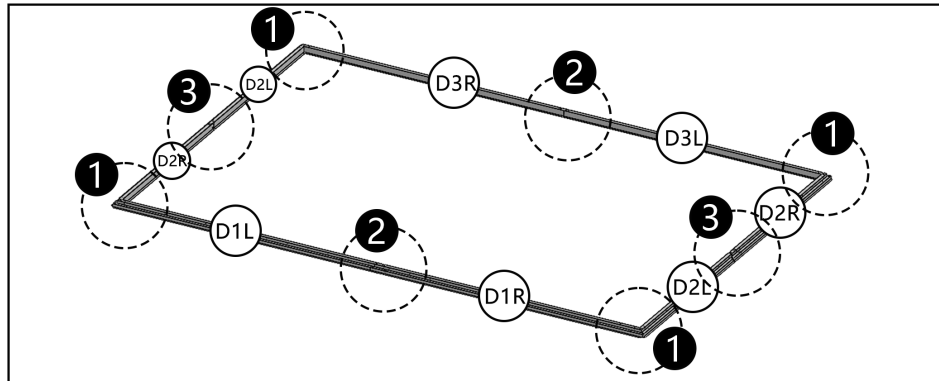

**Notice:**  
Assemble the parts according to the layout shown in the diagram, then secure them in place using F1 as shown in the diagram.

**Assembly Method:** In order to distinguish the orientation of the part, pay attention to the position of the hole in the example drawing

NO.	Part	QTY
F8		8

**step2**

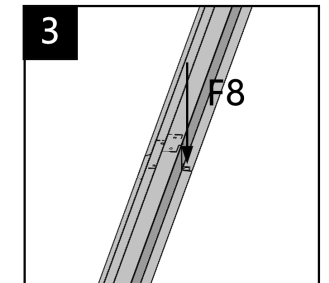
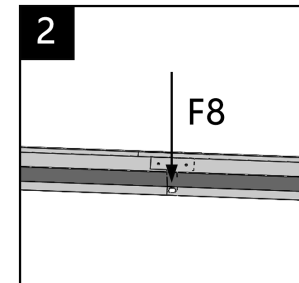
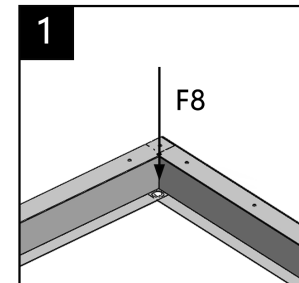
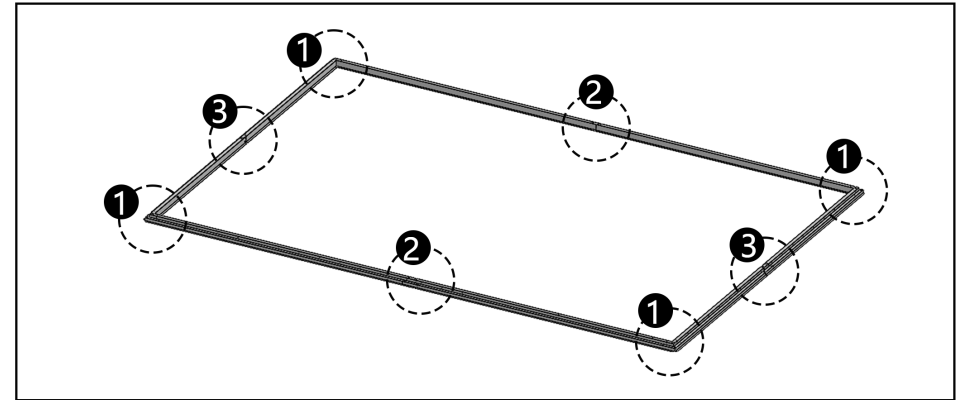

**Notice:**  
A: After installing the base, adjust the dimensions and diagonal dimensions, then insert F8 into the indicated position.  
B: After installing the base, adjust its dimensions and diagonals, then fit the F8 component to the position shown in the diagram.

## 2.Upper frame installation

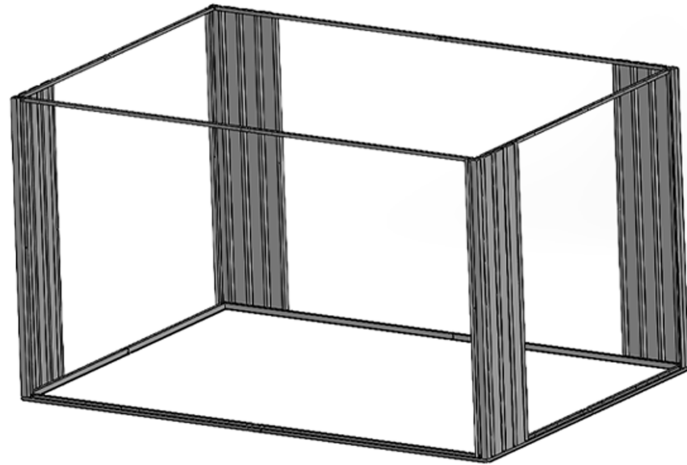

NO.	Part	QTY
Q2		4

NO.	Part	QTY
F1		12

step3

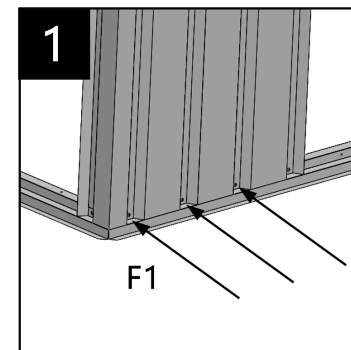
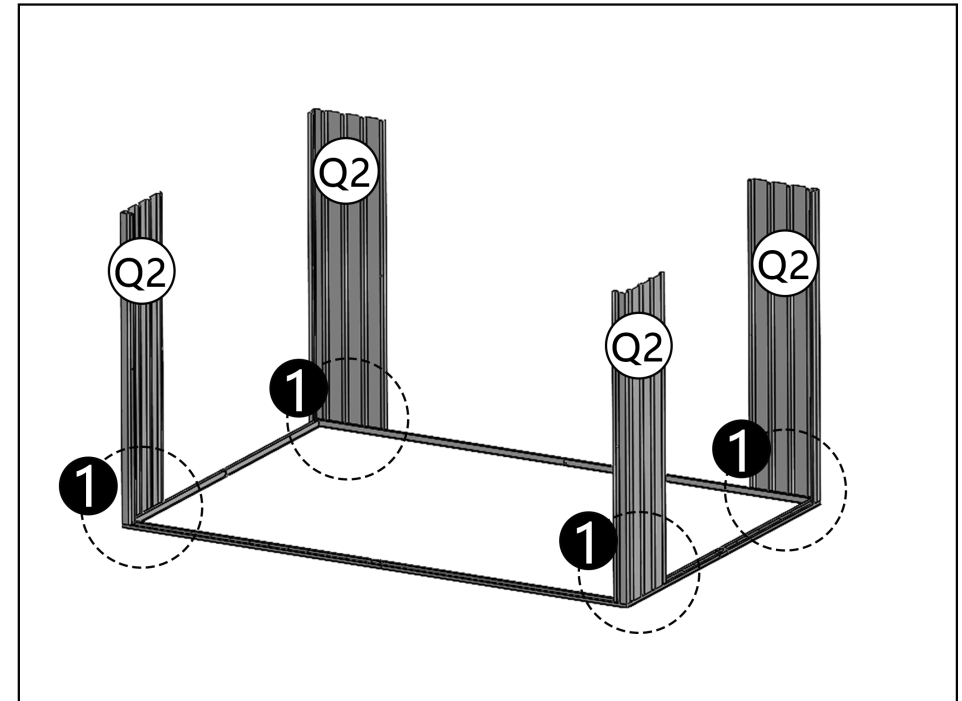

Notice:  
Place Q in the position shown in the figure and use F1 to secure Q2 to the bottom frame. (Leave the screw holes on both sides for subsequent installation of other wall panels.)

**Assembly Method:** In order to distinguish the orientation of the part, pay attention to the position of the hole in the example drawing

NO.	Part	QTY
S1L		1
S2		2
FJT		4

NO.	Part	QTY
S1R		1
S3L		1
F1		4

NO.	Part	QTY
S3R		1
N1		1

**step4**

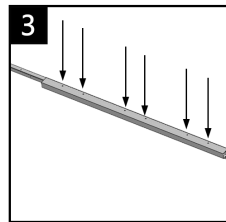
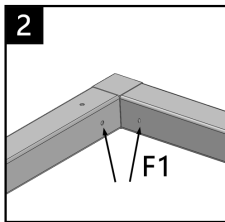
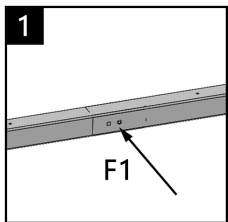
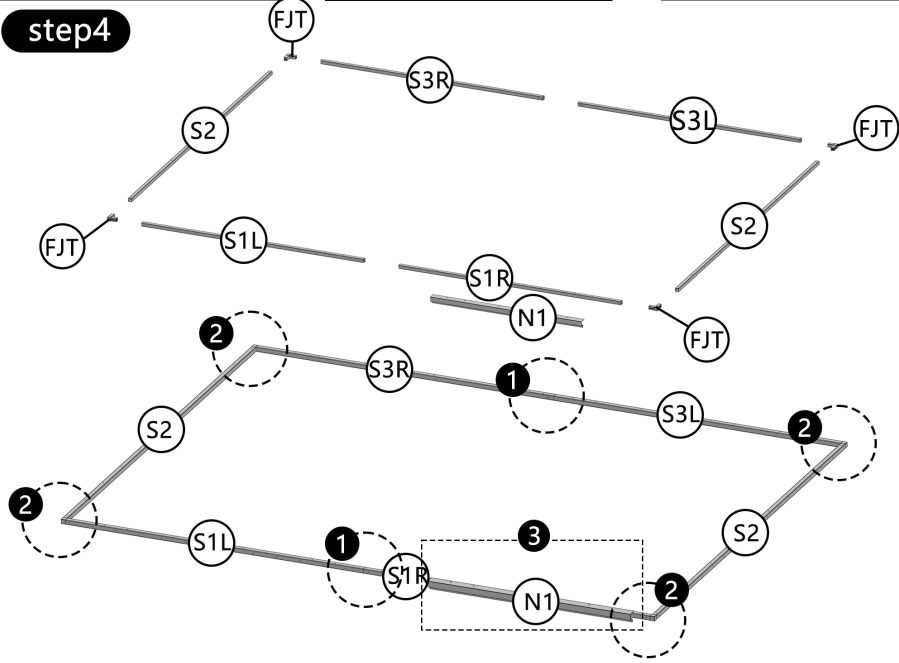

1. Use F1 to connect and secure the end of S3L and S3R with the constricted opening to the end with the square block.
2. Assemble the components according to their positions in the diagram and use F1 to secure the four corners.
3. Place N1 in the position shown in the diagram and align it with the holes above.

**Assembly Method:** In order to distinguish the orientation of the part, pay attention to the position of the hole in the example drawing

NO.	Part	QTY
F1		12

**step5**

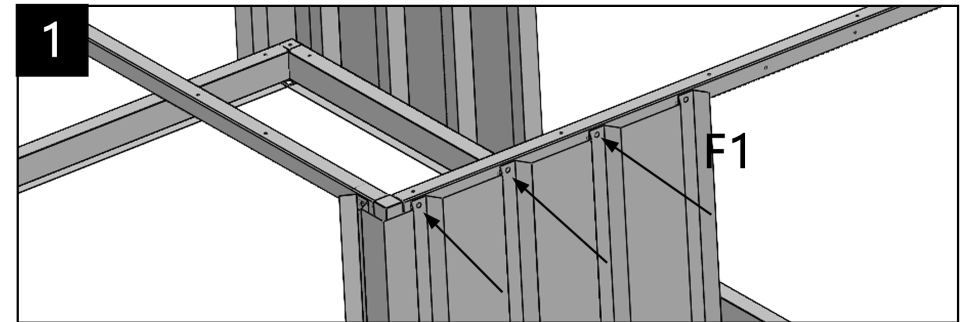
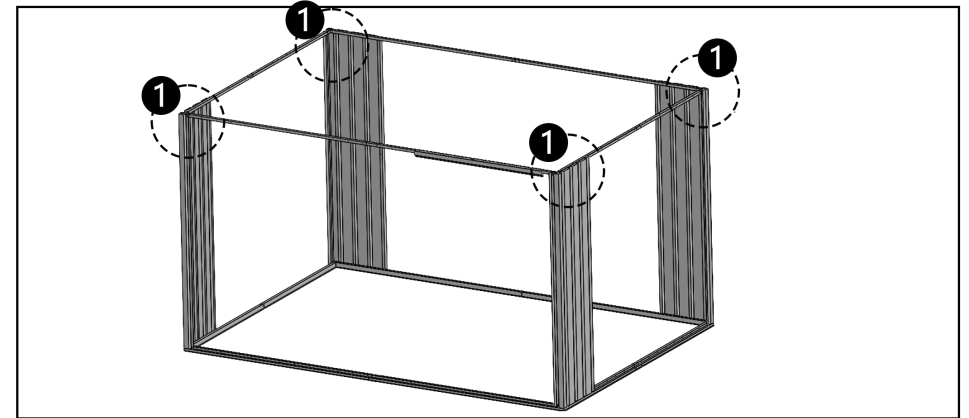

**Notice:**  
Install the upper frame in the position shown in the illustration, and use F1 to secure Q2 to the frame.

### 3.Wall panel door frame installation

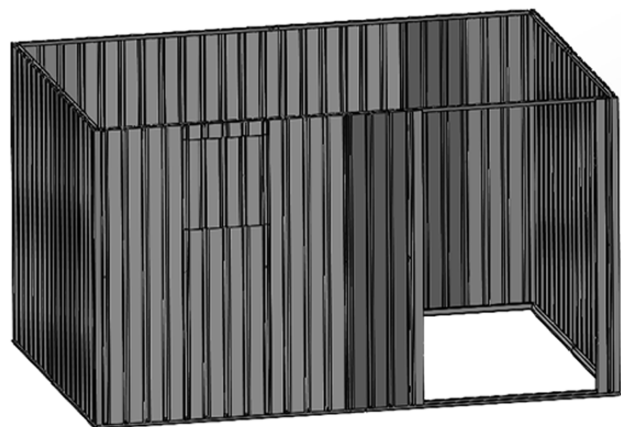

**Assembly Method:** In order to distinguish the orientation of the part, pay attention to the position of the hole in the example drawing

NO.	Part	QTY
Q1		10
Q6		1

NO.	Part	QTY
Q3		6
F1		154

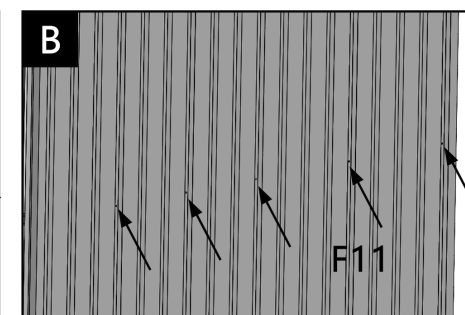
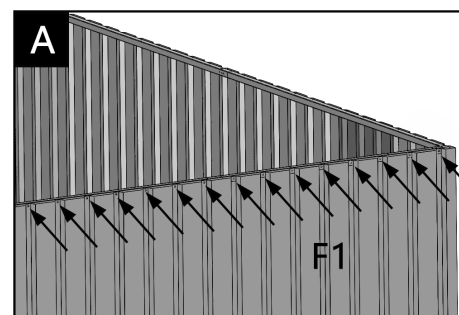
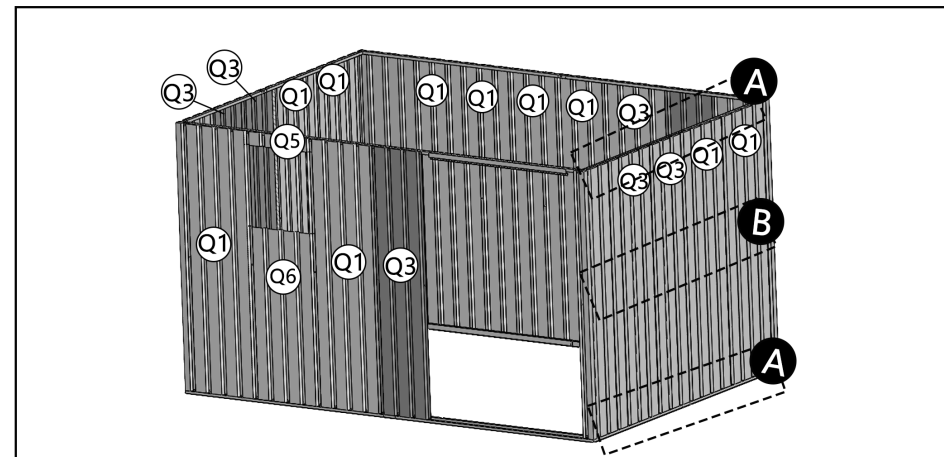

NO.	Part	QTY
Q5		1
F11		20

**step6**



**Notice:**  
Install the wall panels in the order shown in the diagram. First, secure the top and bottom ends to the frame with F1, then use F11 to secure the two wall panels together in the middle.

**Assembly Method:** In order to distinguish the orientation of the part, pay attention to the position of the hole in the example drawing

NO.	Part	QTY
KL		1
F11		2

NO.	Part	QTY
KR		1

NO.	Part	QTY
F1		8

**step7**

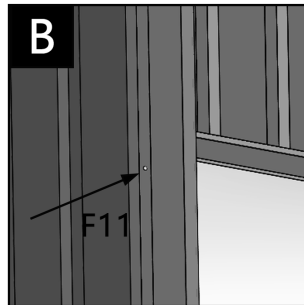
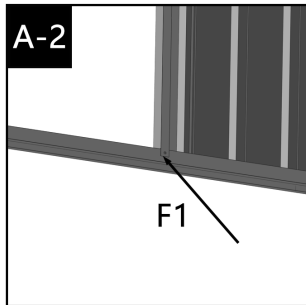
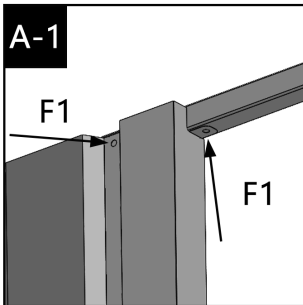
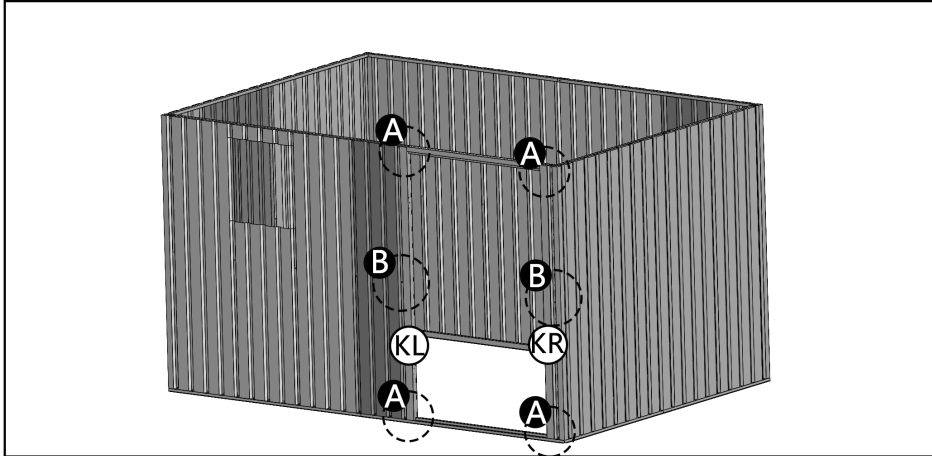

## 4.Roof Tile Support Installation

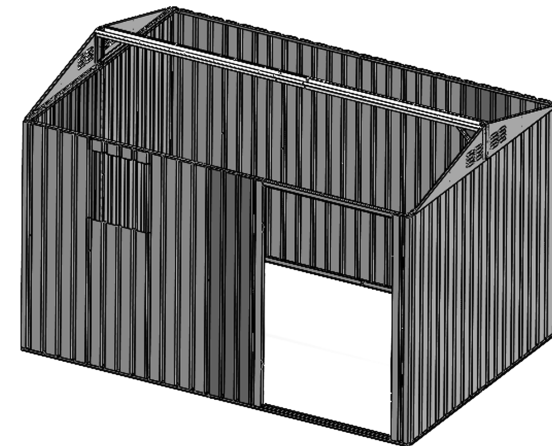

**Notice:**

Place KL and KR in the positions shown in the diagram. First, use F1 to fix the upper and lower ends of KL and KR to the frame. Use F11 to fix the holes in the middle of the door frame to the wall panel.

**Assembly Method:** In order to distinguish the orientation of the part, pay attention to the position of the hole in the example drawing

NO.	Part	QTY
L1L		2
B1		4

NO.	Part	QTY
L1R		2
F1		24

NO.	Part	QTY
C		2
F3		6

**step8**

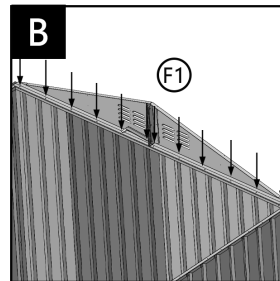
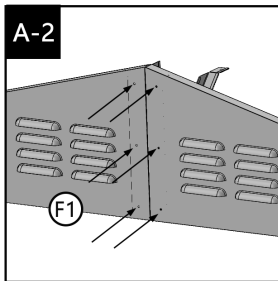
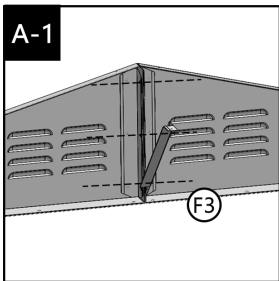
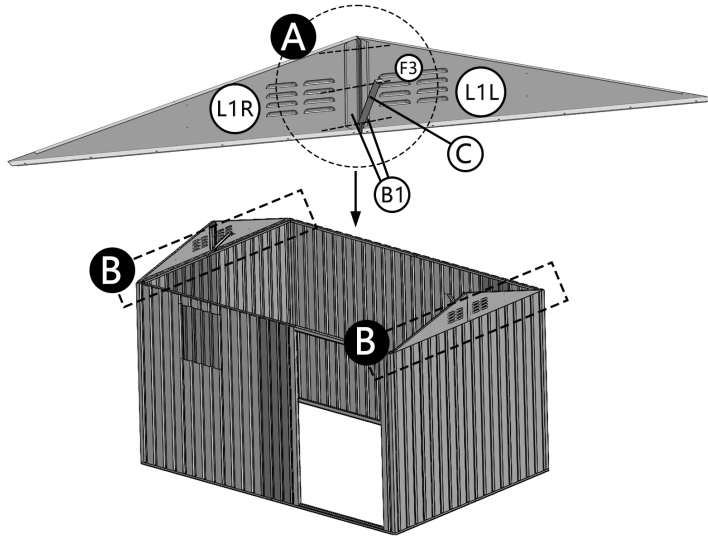

**Notice:**

Align the ends with the large holes of the two B1 components with each other's holes, place them in the position shown in the diagram, then place C in the position indicated, and secure them using F3. Use F1 from the outside of L1L and L1R to fasten B1. Then place the assembled components in the position shown in the diagram and secure them to the frame using F1.

**Assembly Method:** In order to distinguish the orientation of the part, pay attention to the position of the hole in the example drawing

NO.	Part	QTY
L3		2

NO.	Part	QTY
F3		6

NO.	Part	QTY
F1		2

**step9**

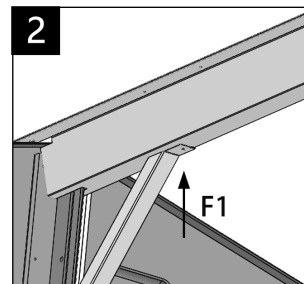
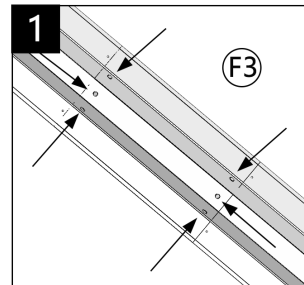
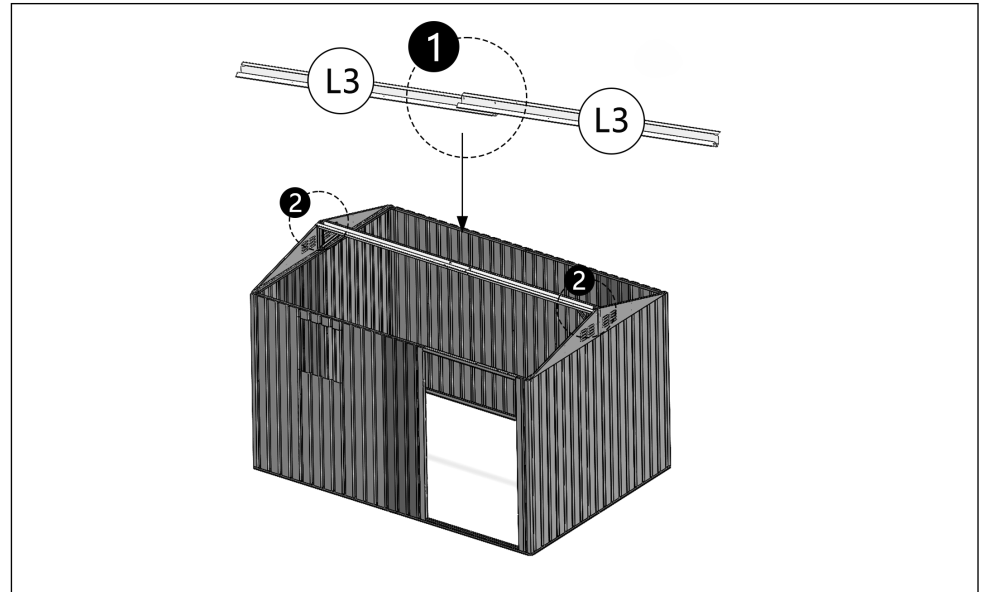

**Notice:**

1. Align the side with more L3 holes, then secure both L3 pieces together using F3 after aligning all six holes.
2. Position the assembled L3 component as shown in the diagram, then secure C to L3 from below using F1.

## 5. Installation of ridge tiles and edging

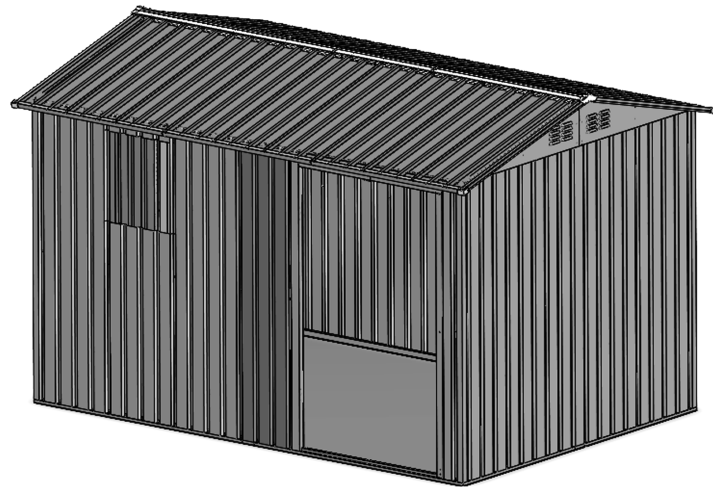

**Assembly Method:** In order to distinguish the orientation of the part, pay attention to the position of the hole in the example drawing

NO.	Part	QTY
Q4		9

NO.	Part	QTY
F1		18

step10

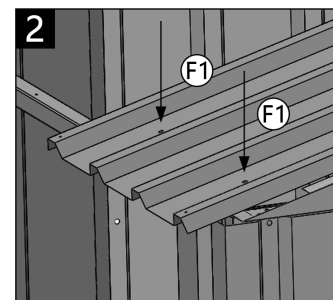
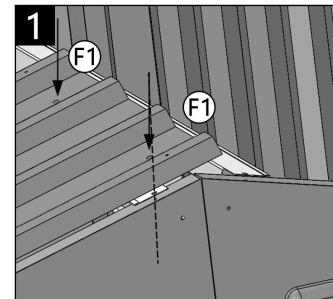
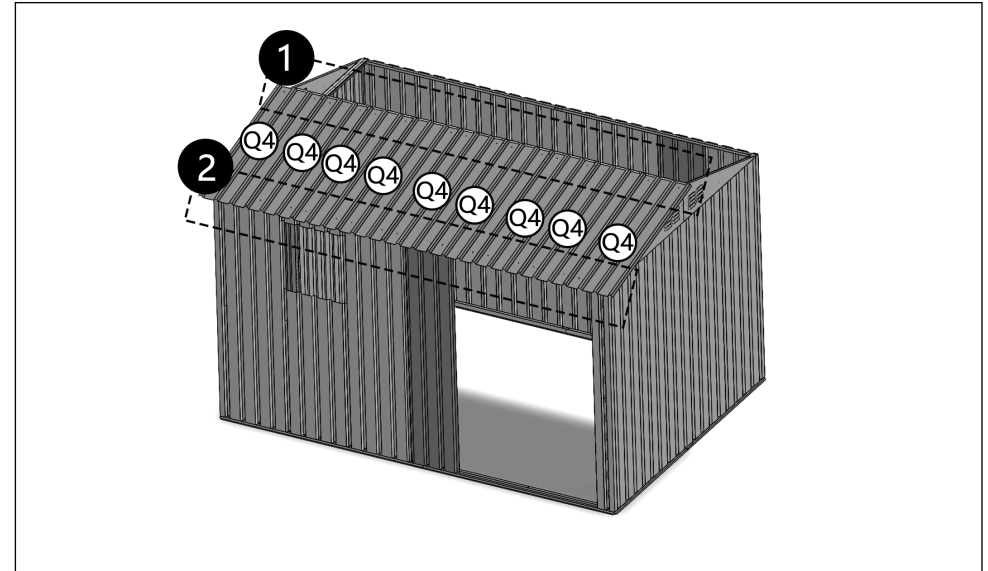

Notice:

Position the Q4 module on the roof, align the mounting holes, then secure both ends to the L3 bracket and frame using F1 fasteners. Stack the next Q4 module atop the existing one, filling one side of the Q4 array first.

**Assembly Method:** In order to distinguish the orientation of the part, pay attention to the position of the hole in the example drawing

NO.	Part	QTY
Q4		7

NO.	Part	QTY
GW1		2

NO.	Part	QTY
F1		31

**step11**

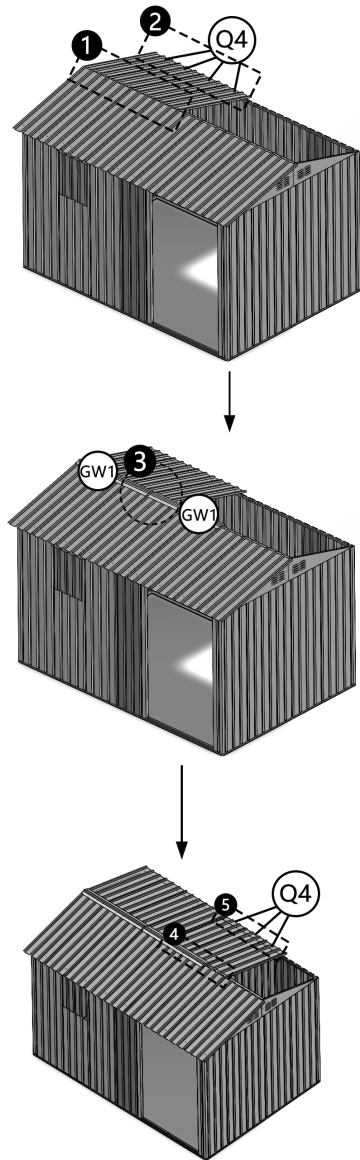

**A**

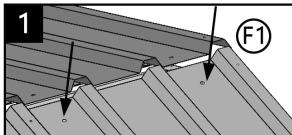

**1**

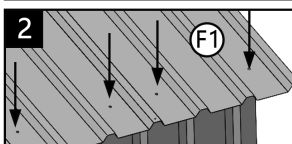

**2**

Notice: Install four Q4 units at the top of the opposite side and secure both ends with F1.

**B**

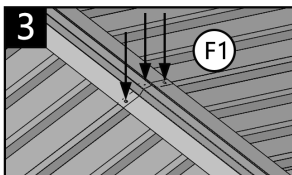

**3**

Notice: After installing four Q4 units, mount two GW1 units above them. Align the holes between the GW1 units and secure them to the Q4 units using F1 fasteners.

**C**

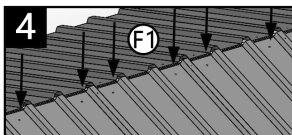

**4**

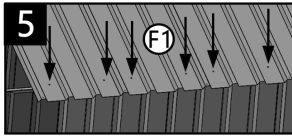



**5**

Notice: After installing GW1, lift GW1 into position and then install the three Q4 units, securing both ends with F1 in the same manner.

**Assembly Method:** In order to distinguish the orientation of the part, pay attention to the position of the hole in the example drawing

NO.	Part	QTY
Q4		2

NO.	Part	QTY
GW1		1

NO.	Part	QTY
F1		11

**step12**

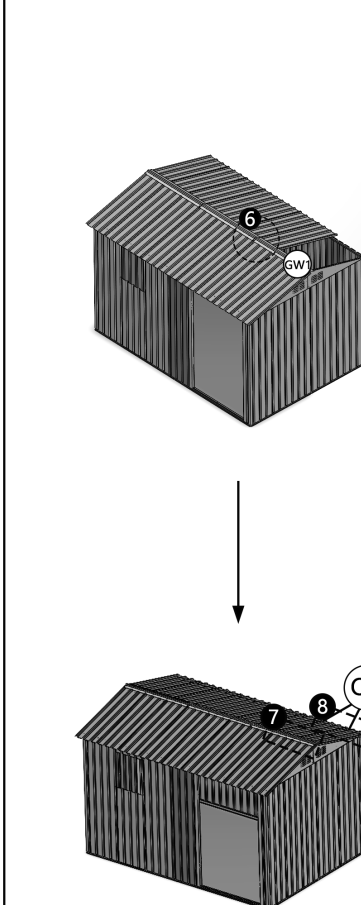

**D**

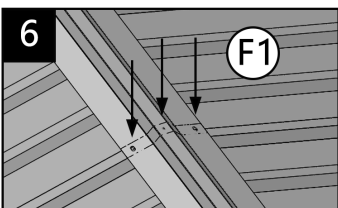

**6**

Notice: Install GW1 at the top, align the mounting holes with another GW1, then secure it to Q4 using F1.

**E**

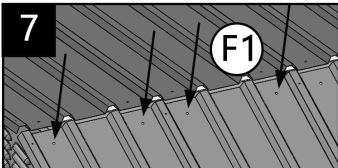

**7**

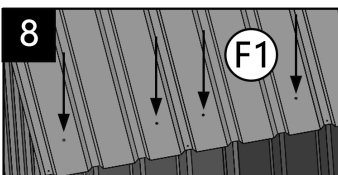

**8**

Notice: After installing GW1, lift GW1 and fit the remaining two Q4 panels, securing them at both ends with F1.

**Assembly Method:** In order to distinguish the orientation of the part, pay attention to the position of the hole in the example drawing

NO.	Part	QTY
GB2		6

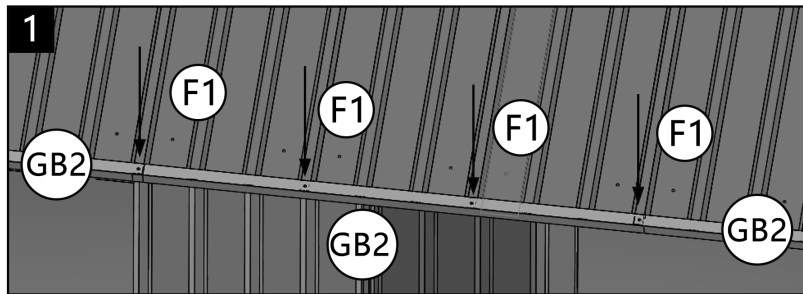
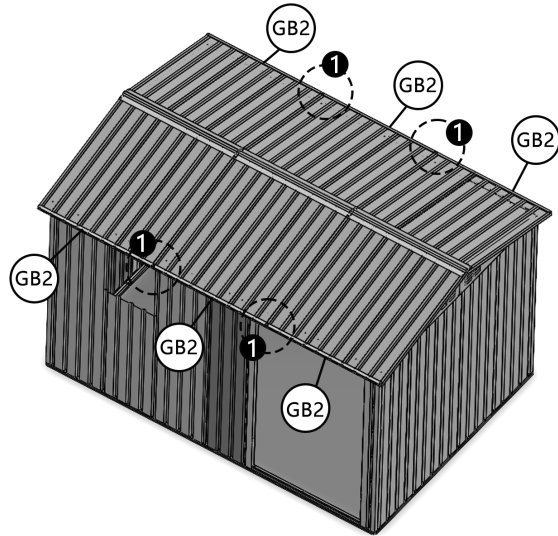

NO.	Part	QTY
F1		16

**step13**



Notice:  
Position GB2 in the corresponding location within the diagram. Align the mounting holes of GB2 with those of Q4, then secure GB2 to Q4 using F1.

**Assembly Method:** In order to distinguish the orientation of the part, pay attention to the position of the hole in the example drawing

NO.	Part	QTY
GB1		4
J1		4

NO.	Part	QTY
GE		2

NO.	Part	QTY
F1		10

**step14**

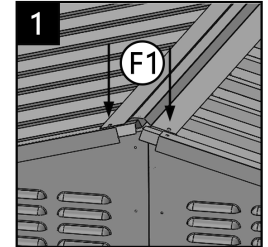
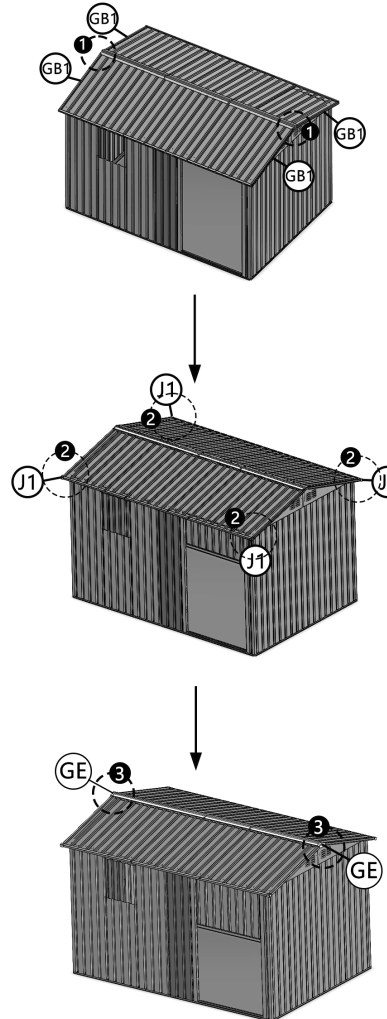

Place GB1 in the position shown in the diagram. Use F1 to secure GB1, GW1, and Q4 together.

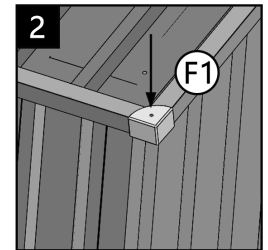

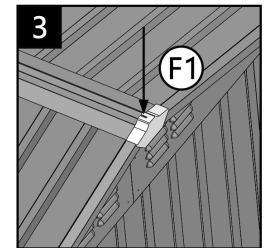

Place J1 at the four corners, then use F1 to secure GB1, GB2, J1, and Q4 together.





Position GE at both ends of the roof. Use F1 to secure GE to GW1.

## 6. Installation of doors and windows

**Assembly Method:** In order to distinguish the orientation of the part, pay attention to the position of the hole in the example drawing

NO.	Part	QTY
M4		1
F4		1

NO.	Part	QTY
M		1
F10		4

NO.	Part	QTY
HY		2

### step15

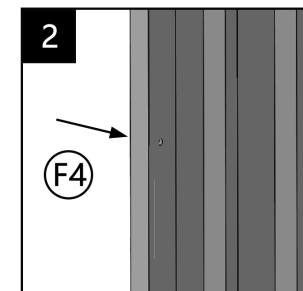
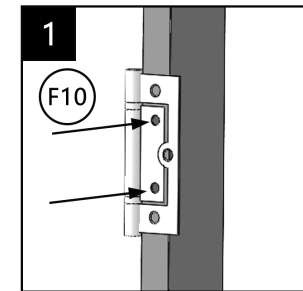
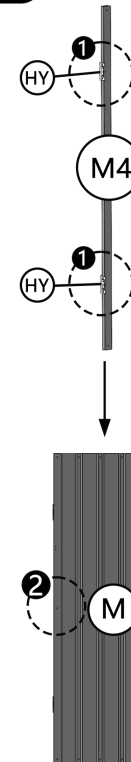
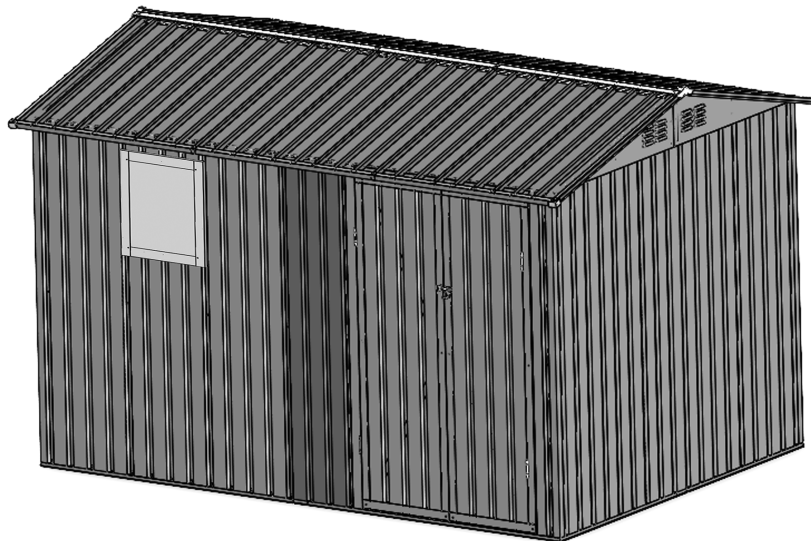

#### Notice:

1. Place HY on the side of M4 and secure it to M4 using F10. (M4 has no specific orientation; pay attention to the installation direction of HY.)
2. Position M on the inner side of M4 and secure it through the central hole using F4.

**Assembly Method:** In order to distinguish the orientation of the part, pay attention to the position of the hole in the example drawing

NO.	Part	QTY
M2		2
F4		4

NO.	Part	QTY
M3		2

NO.	Part	QTY
M5R		1

**step16**

The back of the door

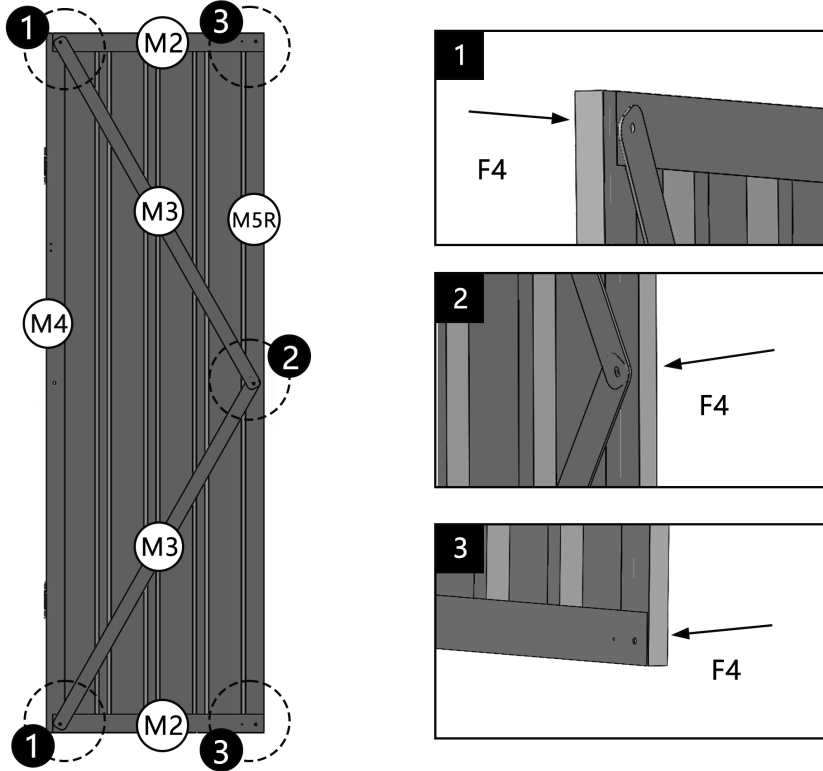

**Notice:**

1. Assemble according to the component positions shown in the image. Use F4 to secure M4, M2, M3, and M together from the front of the door (with the side of M5R featuring multiple center holes facing forward).
2. Use F4 to secure M2, M5R, M3, and M together from the front of the door.
3. Use F4 to secure M2, M5R, and M together from the front of the door.

**Assembly Method:** In order to distinguish the orientation of the part, pay attention to the position of the hole in the example drawing

NO.	Part	QTY
M4		1
F4		1

NO.	Part	QTY
M		1
F10		4

NO.	Part	QTY
HY		2

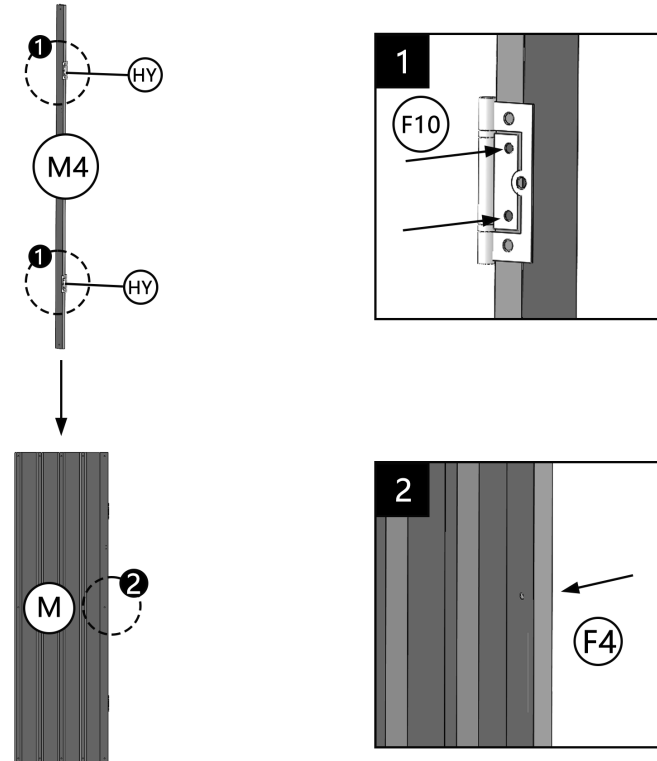

**step17**







**Notice:**

1. Place HY on the side of M4 and secure it to M4 using F10. (M4 has no specific orientation; pay attention to the installation direction of HY.)
2. Position M on the inner side of M4 and secure it through the central hole using F4.

**Assembly Method:** In order to distinguish the orientation of the part, pay attention to the position of the hole in the example drawing

NO.	Part	QTY
M2		2
F4		4

NO.	Part	QTY
M3		2
F1		4

NO.	Part	QTY
M5L		1
CS		2

**step18**

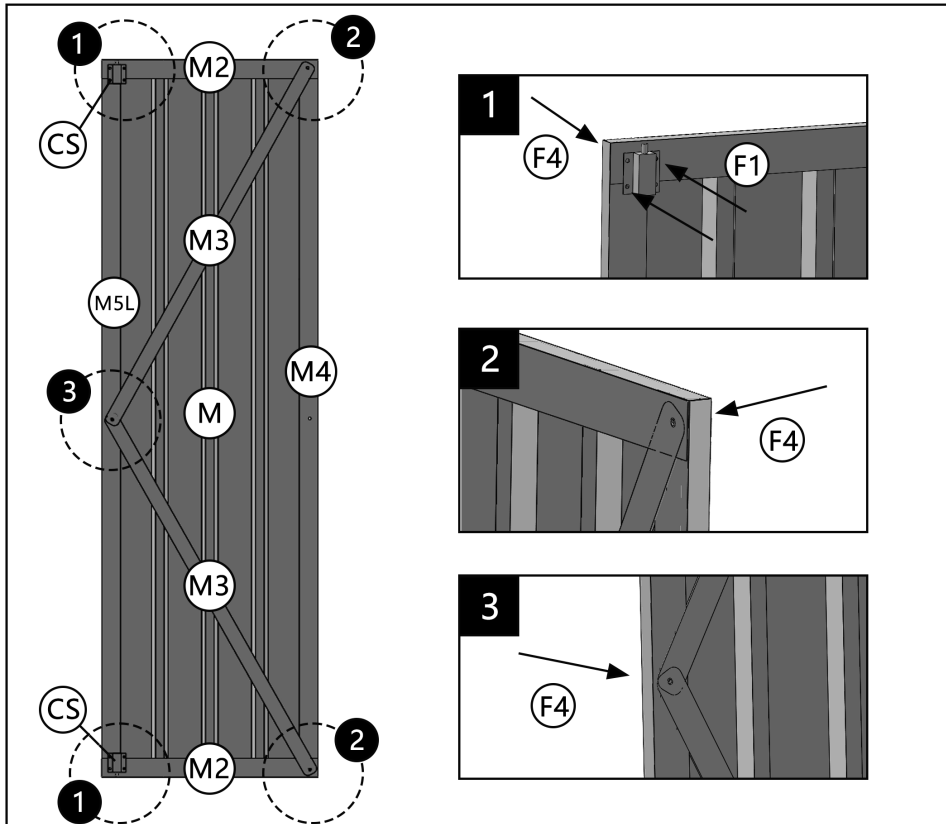



**Notice:**

1. Assemble the door components according to the diagram. Use F4 to secure M2, M5L, M, and CS together from the front. Align the CS hole with the door and secure it with F1.
2. Use F4 to secure M2, M4, M, and M3 together from the front.
3. Use F4 to secure M5L, M3, and M together from the front.

**Assembly Method:** In order to distinguish the orientation of the part, pay attention to the position of the hole in the example drawing

NO.	Part	QTY
F10		12

NO.	Part	QTY
F1		7

NO.	Part	QTY
SK		1

**step19**

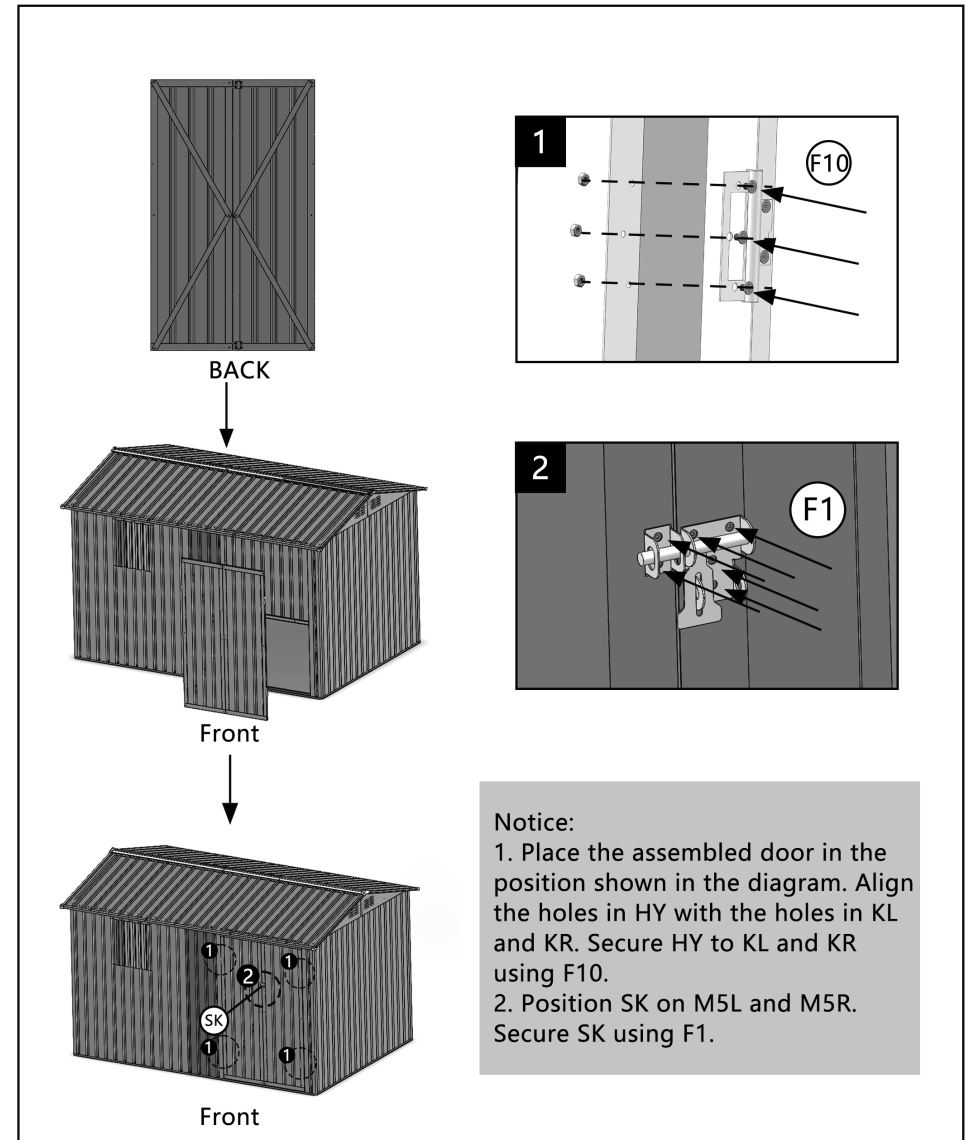

**Notice:**

1. Place the assembled door in the position shown in the diagram. Align the holes in HY with the holes in KL and KR. Secure HY to KL and KR using F10.
2. Position SK on M5L and M5R. Secure SK using F1.

**Assembly Method:** In order to distinguish the orientation of the part, pay attention to the position of the hole in the example drawing

NO.	Part	QTY
W1		1
W4		2

NO.	Part	QTY
W2		2
F9		4

NO.	Part	QTY
W3		2

**step20**

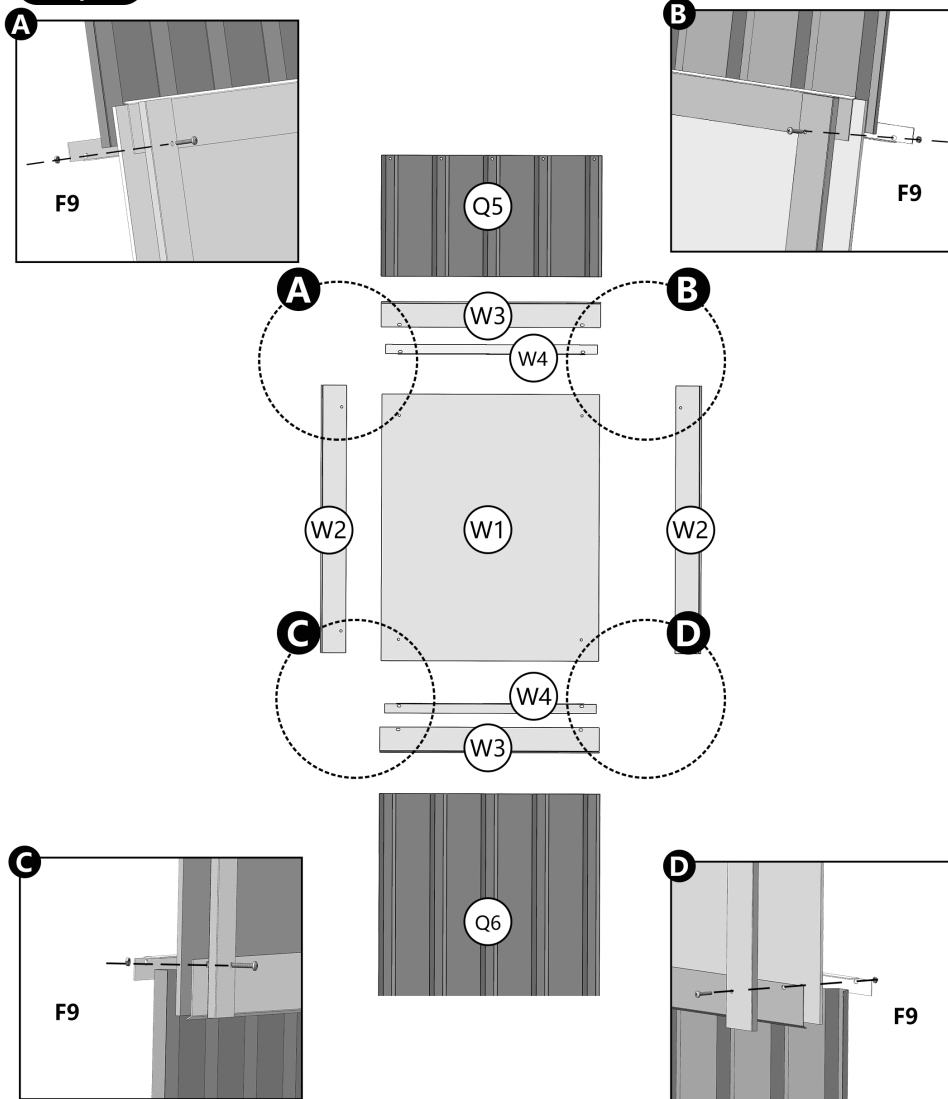

**Assembly Method:** In order to distinguish the orientation of the part, pay attention to the position of the hole in the example drawing

Notice:

Step 1: Use F9 screw rod to fix W2 and W3

Step 2: Mount W1 to W2, W3 frame (F9 screw through W1)

Step 3: Place the installed window in the window,

Step 4: Insert W4 into the screw of F9 and tighten the nut

