

ASSEMBLY AND CARE INSTRUCTION

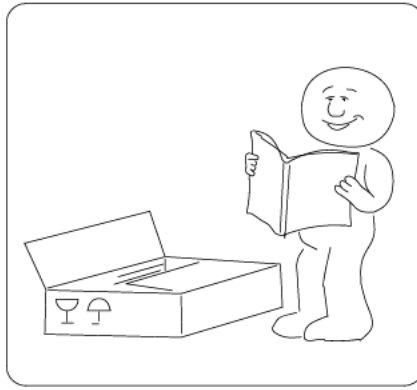

! WARNING !

1. PLEASE READ ALL INSTRUCTIONS CAREFULLY BEFORE STARTING ASSEMBLY.
2. DO NOT LET ANY SHARP OBJECTS TOUCH OR RUB THE SURFACE OF THE PRODUCT.
3. WHEN ASSEMBLING, DO NOT LET CHILDREN PLAY AROUND THE WORKING AREA.
4. PLEASE CONFIRM ALL PARTS ARE CORRECT BEFORE STARTING THE ASSEMBLY PROCESS.
5. DO NOT TIGHTEN ALL BOLTS AND SCREWS COMPLETELY UNTIL THE ENTIRE UNIT HAS BEEN ASSEMBLED AND SET UP.

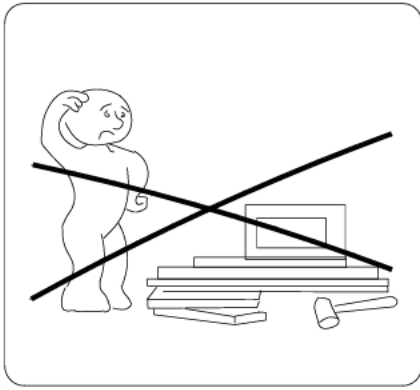
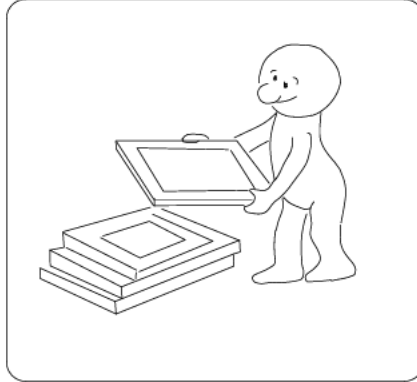
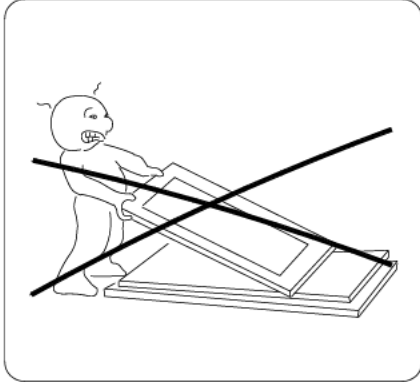

ADVISE

1. DO NOT SIT OR STAND ON THIS PRODUCT. IT IS INTENDED FOR PETS ONLY.
2. THIS PRODUCT SHOULD BE ASSEMBLED BY AN ADULT.
3. PLEASE PUT THE PRODUCT ON A SMOOTH SURFACE AFTER YOU ASSEMBLED IT.
4. PLACE ALL PARTS ON A CLEAN AND SMOOTH SURFACE SUCH AS A RUG OR CARPET TO AVOID THE PARTS FROM BEING SCRATCHED.
5. THE SCREW OF HINGE ON THE DOOR ALSO CAN BE ADJUSTABLE, TO MAKE IT EVEN THEN TIGHTEN ALL SCREWS.

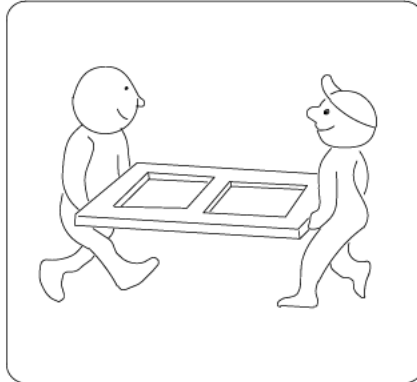
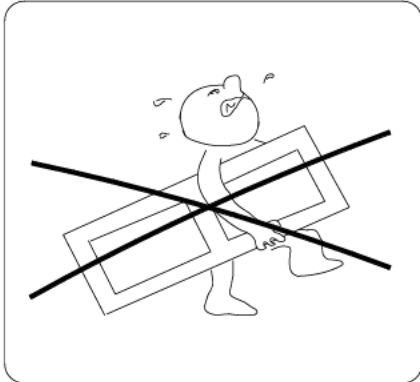

TOOL NEEDED

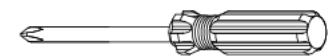

**SCREWDRIVER REQUIRED
- NOT INCLUDED**

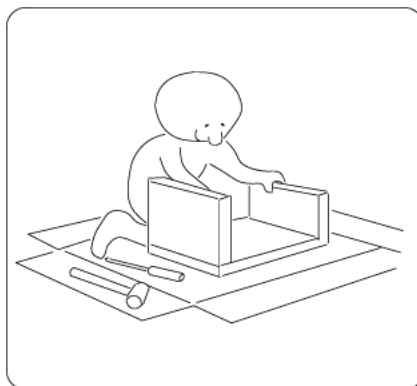
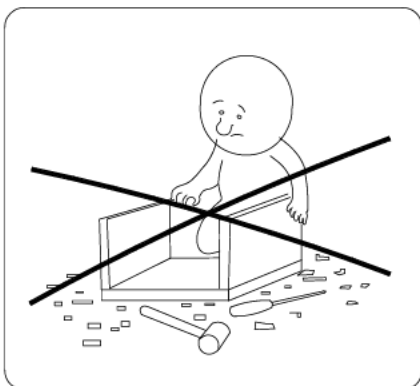
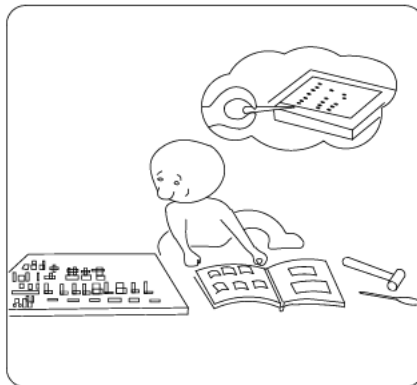
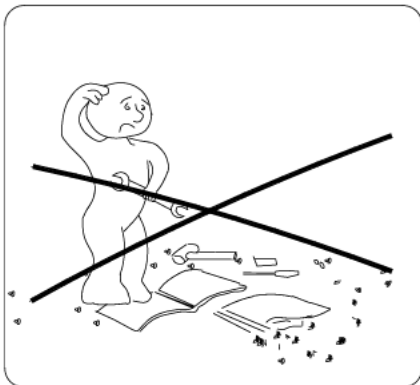

PARTS

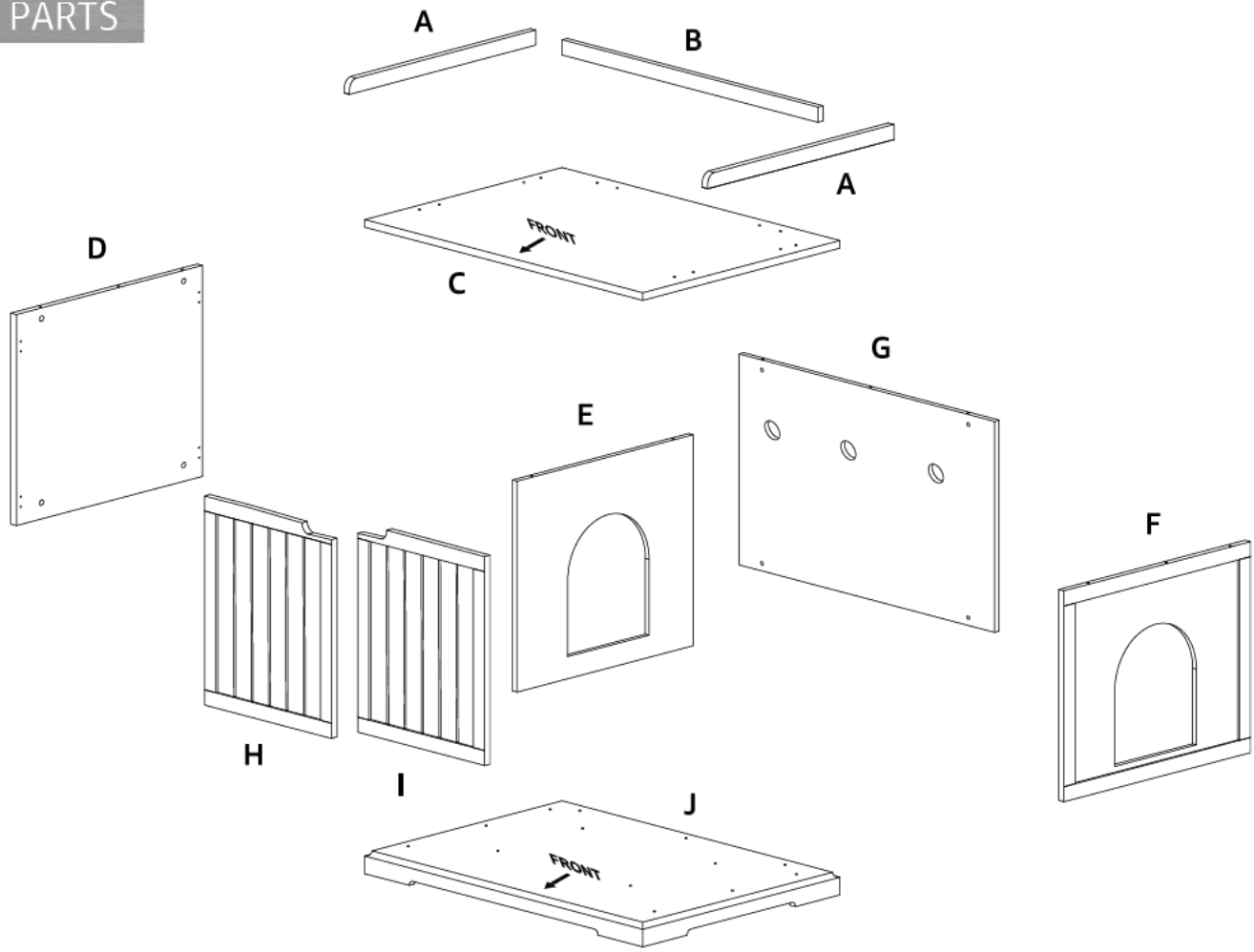

A
Upper Side Apron
x2



B
Upper Back Apron
x1

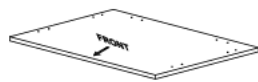

C
Top Panel
x1

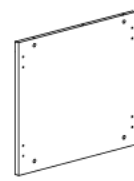

D
Side Panel
x1

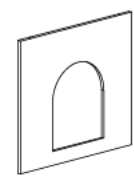

E
Divider Panel
x1

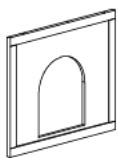

F
Side Panel With Door
x1

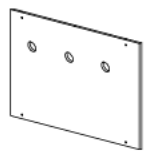

G
Back Panel
x1



H
Left Door Panel
x1



I
Right Door Panel
x1

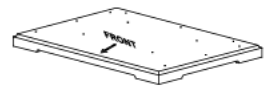

J
Bottom Panel
x1

HARDWARE



1
x 14 pcs



2
x 14 pcs



3
x 14 pcs



4
x 2 pcs



5
x 6 pcs



6
x 4 pcs



7
x 24 pcs



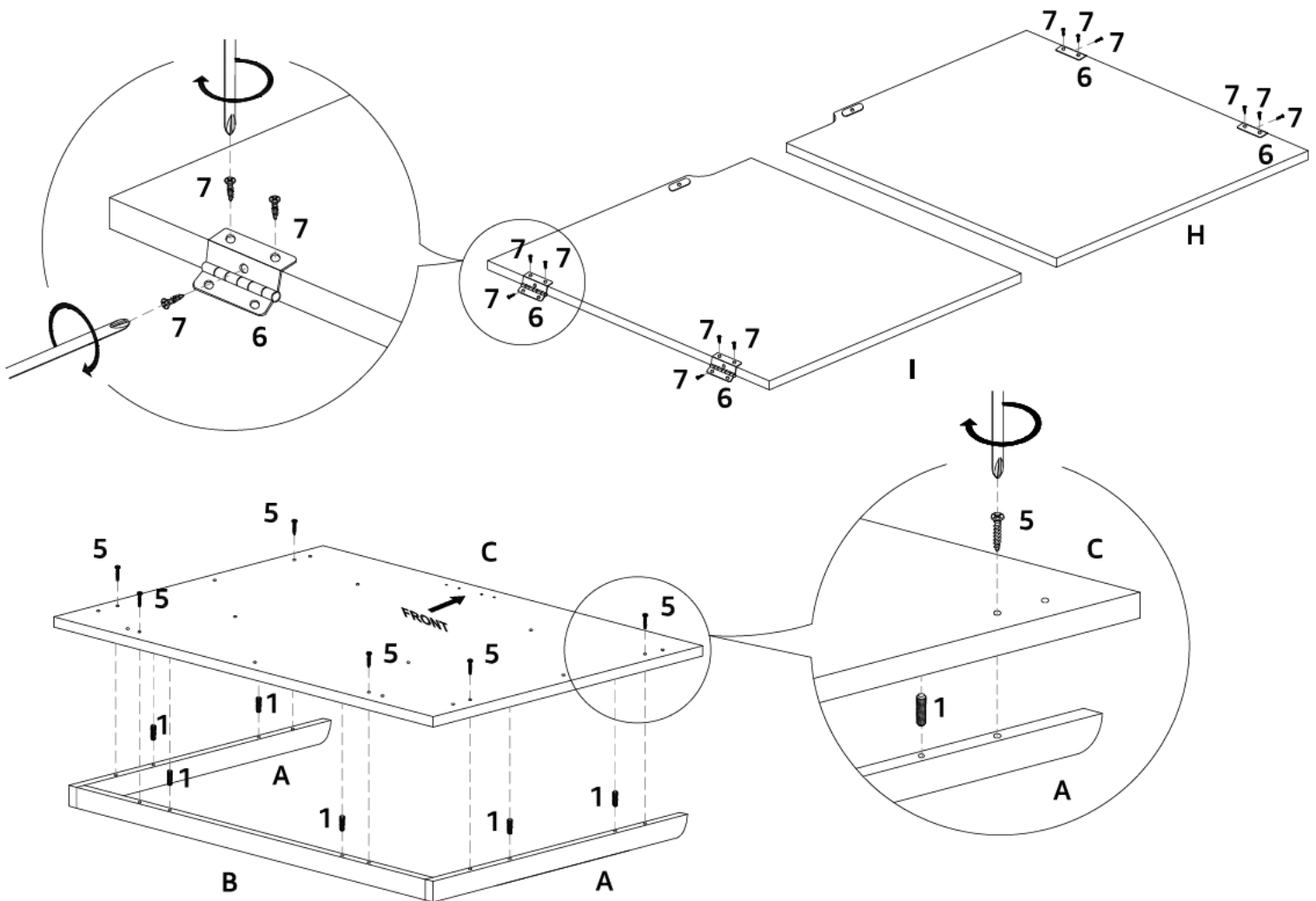

ASSEMBLY INSTRUCTIONS

- Install hinge 6 onto left and right door H, I by screw 7.
 Insert wood dowel 1 into the upper side aprons A and upper back apron B.
 Connect upper side aprons A and upper back apron B with top panel C.
 Tighten them with screw 5.

| | | | |
|--------------|--------------|--------------|---------------|
| | | | |
| 1 x 6 pcs | 5 x 6 pcs | 6 x 4 pcs | 7 x 12 pcs |



- 2** Install the magnet 4 to top panel C and tighten them with screw 7.
Tighten the pin 2 into the hole of the bottom panel J & top panel C.
Insert wood dowel 1 into the bottom panel J.

| | | | |
|---|---|---|---|
|  |  |  |  |
| 1 x 3 pcs | 2 x 14 pcs | 4 x 2 pcs | 7 x 4 pcs |

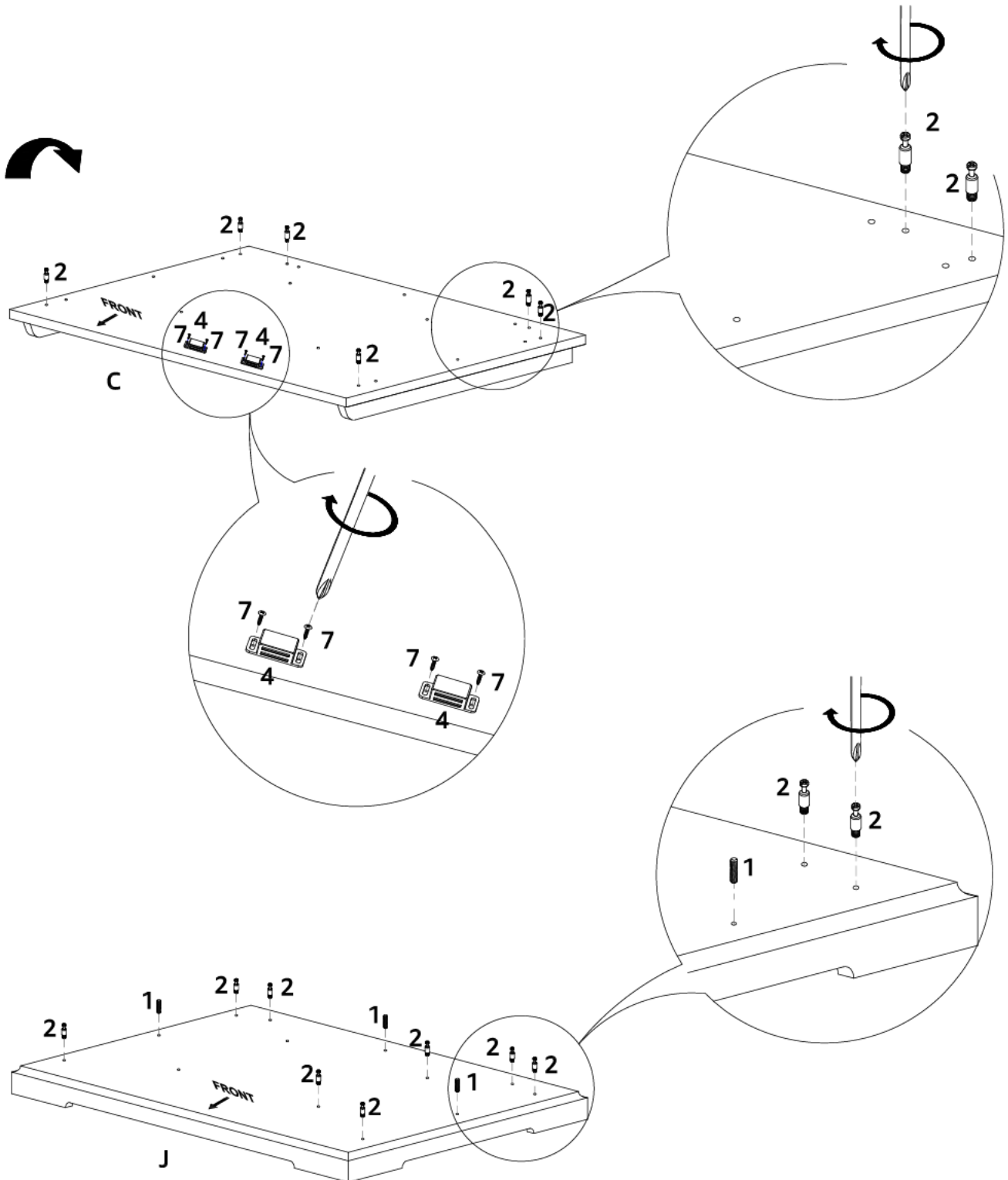





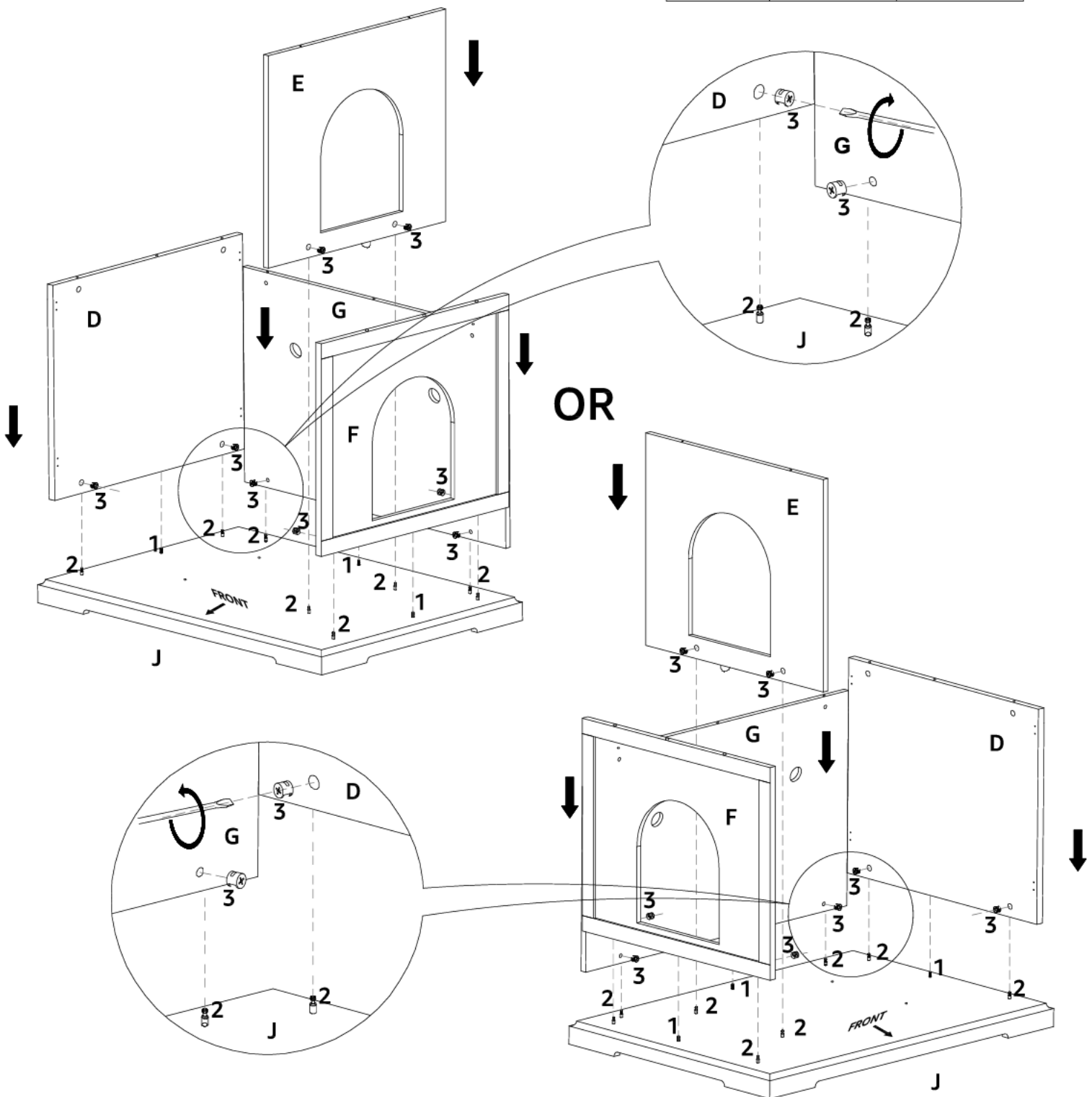
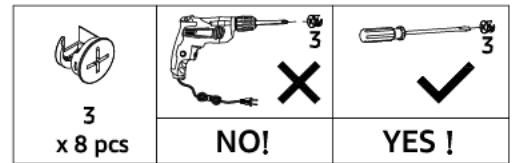

3

Connect side panel D, back panel G, side panel with door F and divider panel E to the bottom panel J. (Attention: the divider panel E and the side panel with door F can be install on the left or right side depend on the customer as the images shows below.) Insert the cam lock 3 into the hole of side panel D, back panel G and side panel with door F, then tighten cam lock 3 to pin 2.

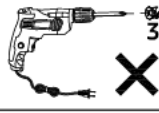

4

Insert wooden dowel 1 on the hole of the divider panel E, side panel D and F and back panel G, put the top panel C onto the product, insert the cam lock 3 on the hole of side panel D and F and back panel G, then tighten cam lock 3 to pin 2. Install the hinge 6 to side panel D with screw 7.

| | | | | |
|---|---|--|--|---|
|  7 x 4 pcs |  1 x 5 pcs |  3 x 6 pcs |   NO! |   YES! |
|---|---|--|--|---|

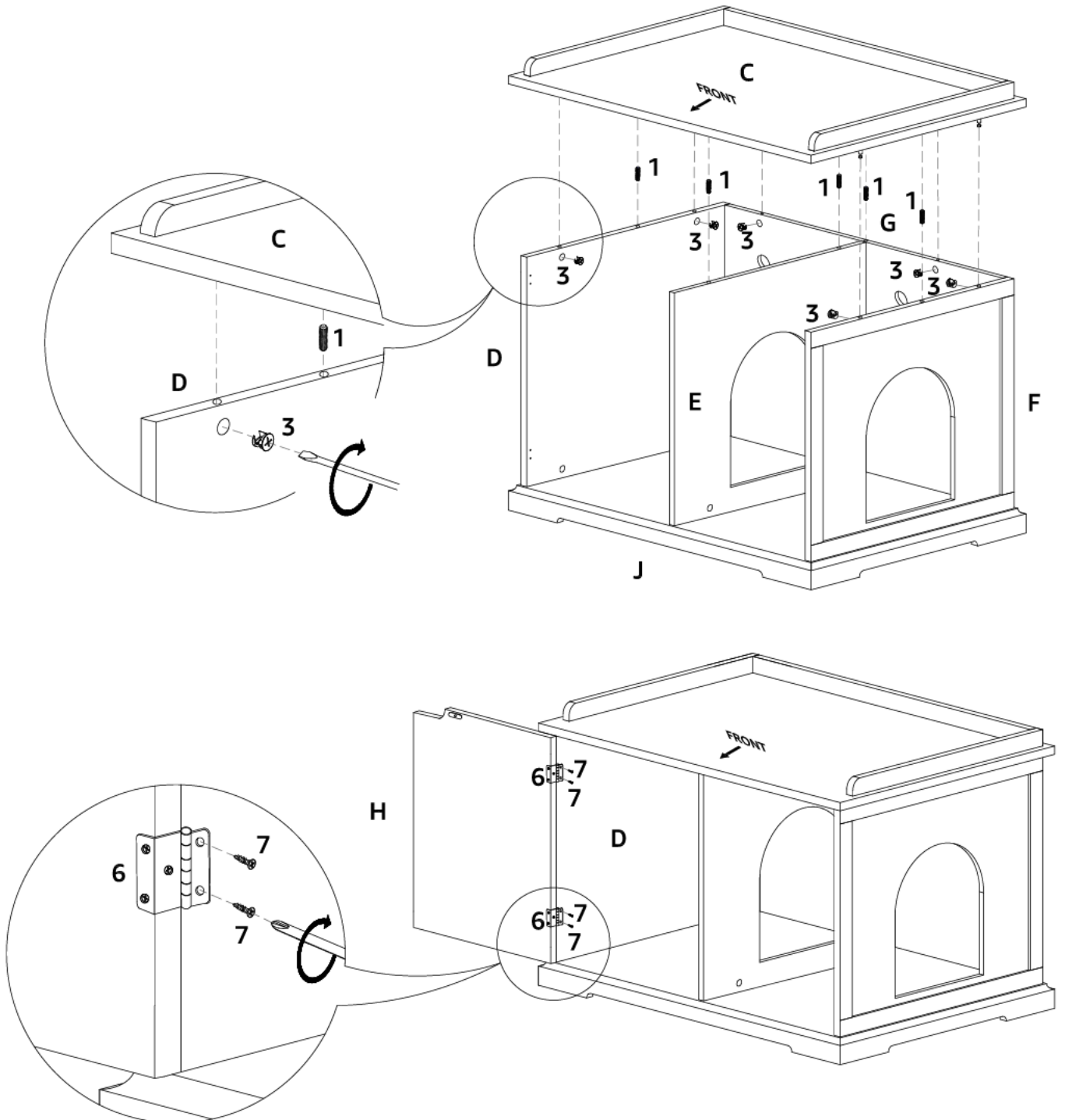

5

Install the hinge 6 to side panel I with screw 7, install completed.

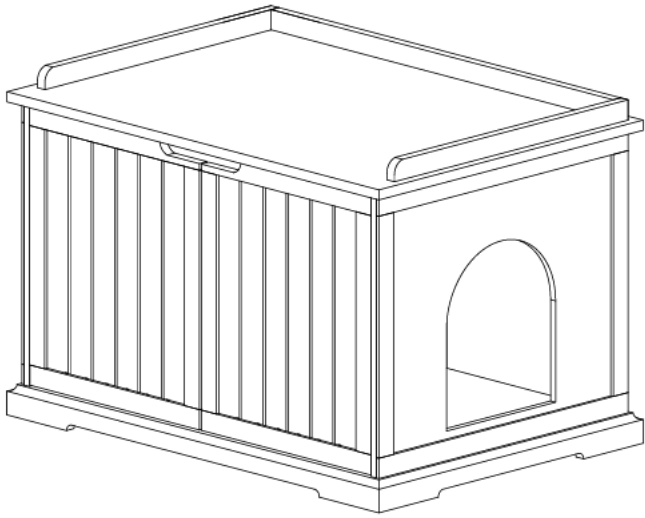
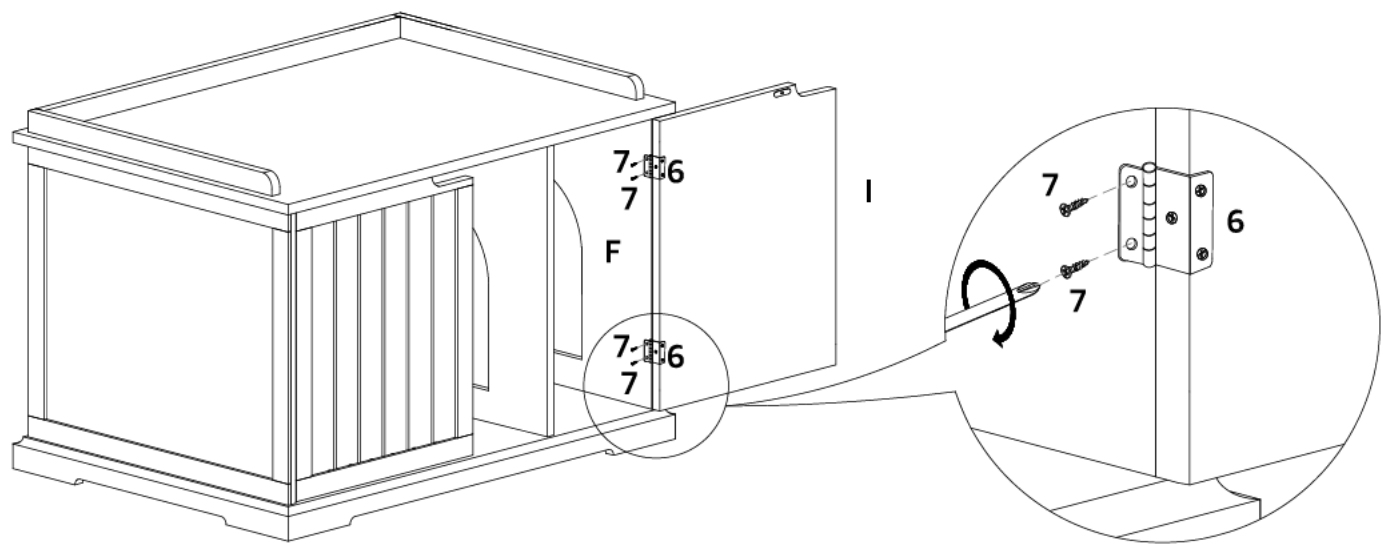
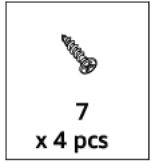

or

