

Sideboard Cabinet

Date of PURCHASE ____/____/____

lot Number:

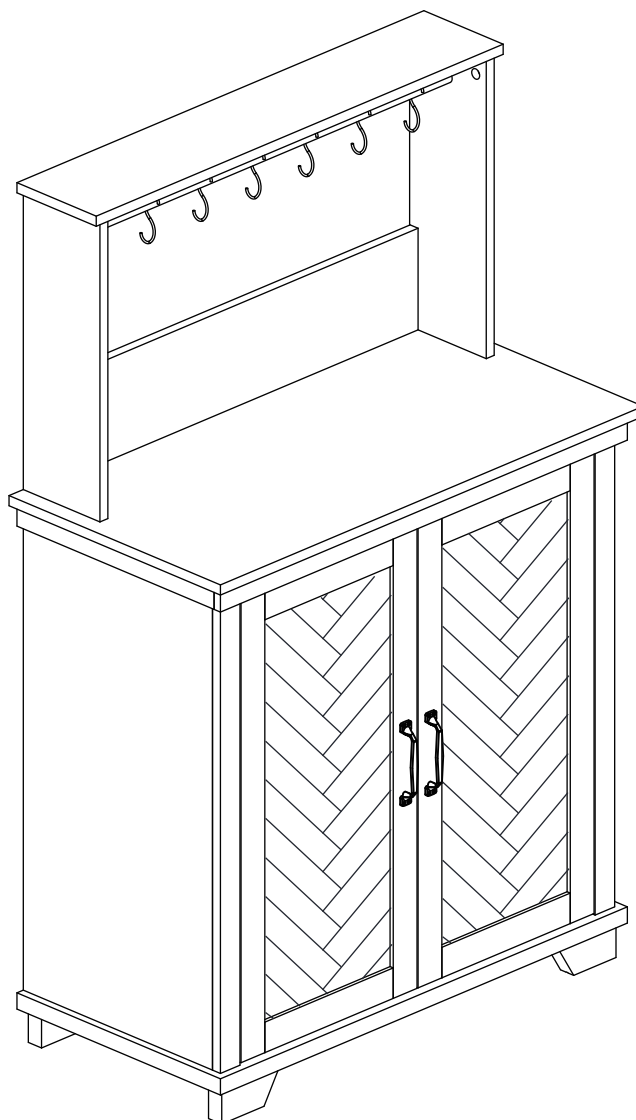

THIS INSTRUCTION BOOKLET CONTAINS IMPORTANT SAFETY INFORMATION. PLEASE READ AND KEEP FOR FUTURE REFERENCE.

Do Not Return This Product!

Contact our customer service team
for help first.



WARNING

- Unit can tip over causing severe injury or death.
- Anchor unit to stud in wall (if instructed to)
- Do Not allow children to climb on unit.
- put heavy items on lower shelves or drawers.

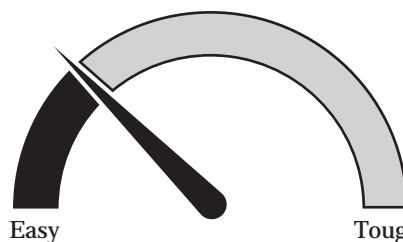

Assembly Difficulty Meter

CONTACT US!

Do NOT return this product!

Contact our friendly customer service team first for help.

HELPFUL HINTS

PEOPLE NEEDED FOR ASSEMBLY:2
ESTIMATED ASSEMBLY TIME:1 HOUR

- Open your item in the area you plan to keep it to avoid excessive heavy lifting.
- Identify,sort and count the parts before attempting assembly.
- Back panel must be used to make sure your unit is sturdy.
- Do NOT use harsh chemicals or abrasive cleaners on this item.
- Never push,pull,or drag your furniture.







BEFORE YOU START

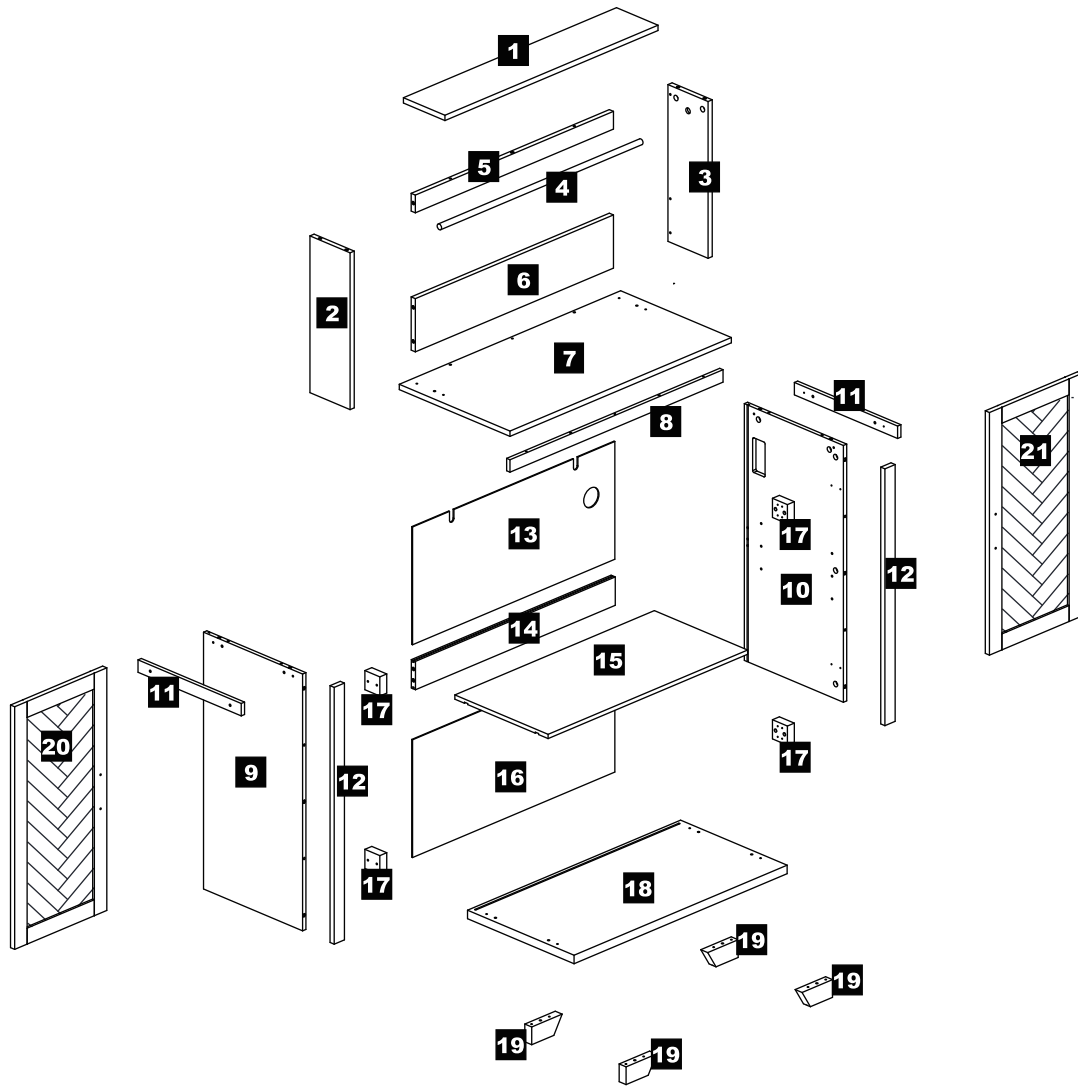





- Read through each step carefully and follow the proper order
- Separate and count all your parts and hardware
- Give yourself enough room for the assembly process
- Have the following tools:Flat Head Screwdriver,#2 Phillips Head Screwdriver and Hammer
- Caution: IF using a power drill or power screwdriver for screwing,please be aware to slow down and stop when screw is tight.Failure to do so may result in stripping the screw.

BOARD IDENTIFICATION

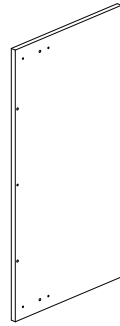

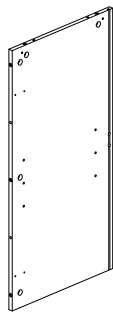
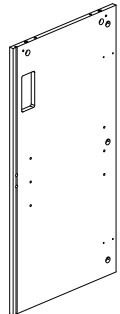
<p>1</p>  <p>1PC</p>	<p>2</p>  <p>1PC</p>	<p>3</p>  <p>1PC</p>	<p>4</p>  <p>1PC</p>	<p>5</p>  <p>1PC</p>
--	--	--	--	--

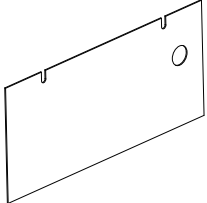
BOARD IDENTIFICATION

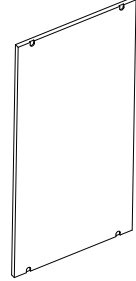
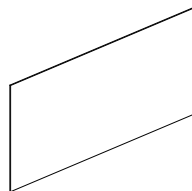
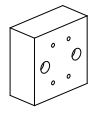
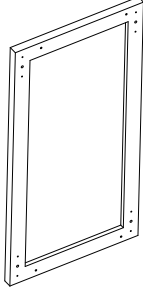
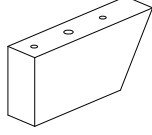
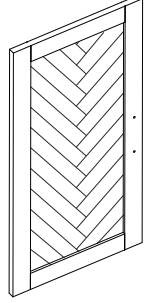
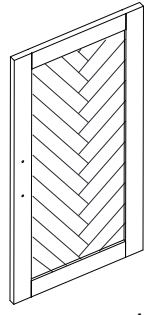
<p>6</p>  <p>1PC</p>	<p>7</p>  <p>1PC</p>	<p>8</p>  <p>1PC</p>	<p>9</p>  <p>1PC</p>	<p>10</p>  <p>1PC</p>
<p>11</p>  <p>2PCS</p>	<p>12</p>  <p>2PCS</p>	<p>13</p>  <p>1PC</p>	<p>14</p>  <p>1PC</p>	<p>15</p>  <p>1PC</p>
<p>16</p>  <p>1PC</p>	<p>17</p>  <p>4PCS</p>	<p>18</p>  <p>1PC</p>	<p>19</p>  <p>4PCS</p>	<p>20</p>  <p>1PC</p>
<p>21</p>  <p>1PC</p>				

THE HARDWARES

A



Cam bolt

26+2 PCS

B



Cam lock

26+2 PCS

C

6 x 30mm



Wood dowel

24+2 PCS

D

6 x 20mm

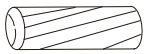

Wood dowel

4PCS

E



Handle

2PCS

F

4 x 18mm

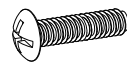

Bolt

4PCS

G

4 x 60mm

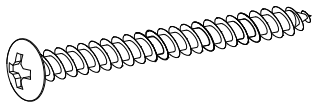

Screw

8+1PCS

H

4 x 45mm

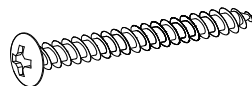

Screw

4PCS

I

4 x 40mm

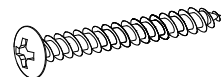

Screw

7PCS

J

4 x 30mm

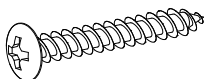

Screw

10+1 PCS

K

4 x 20mm

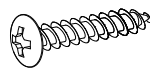

Screw

4 PCS

L









4 x 12mm

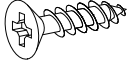
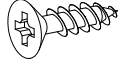

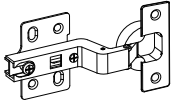
Screw

2 PCS

THE HARDWARES

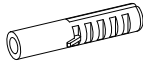
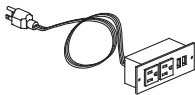
M 4 x 14mm	N 3 x 14mm	O
		
Screw	Screw	Bumper
24+2PCS	10+1PCS	2PCS
P	Q	R
		
Hinge	Metal Support	Hook
4PCS	4PCS	6PCS
S	T	U
		
Wall Bracket	Back Buckle	Cam Cover
2 PCS	8+1 PCS	4 PCS
V	W	
		
Wall Anchor	Power Strip	
2 PCS	1 PC	

TOOLS REQUIRED

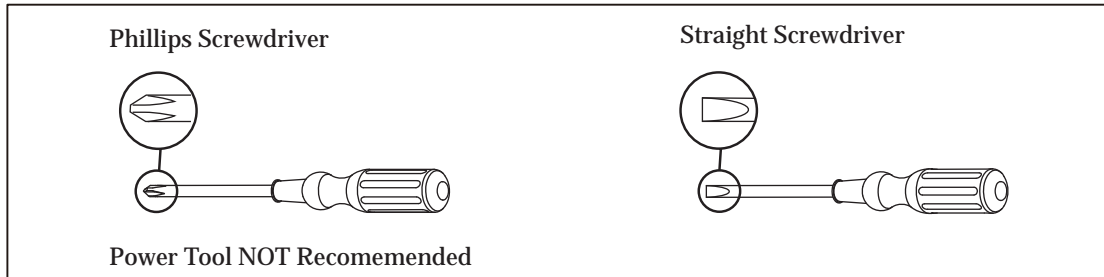

To ensure proper assembly we have included the following guides:

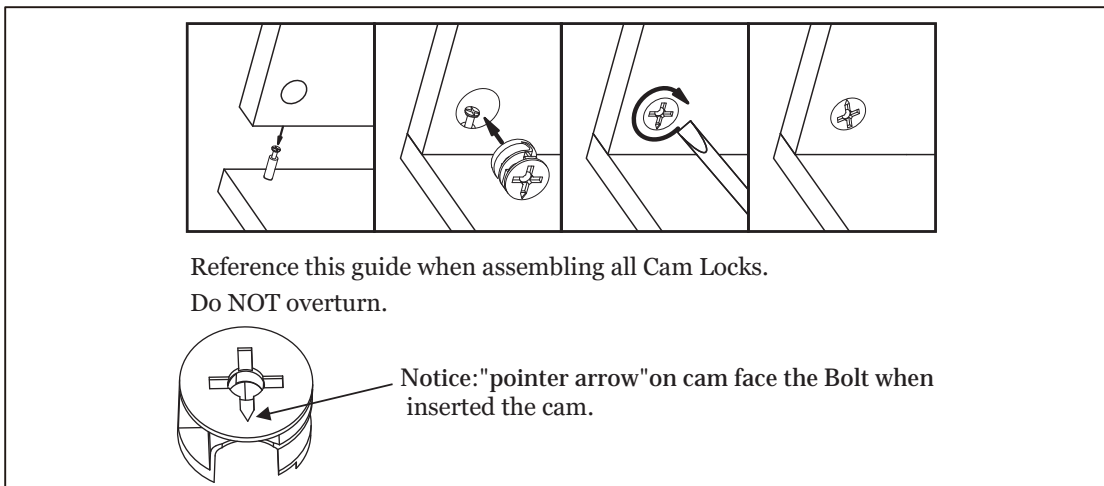
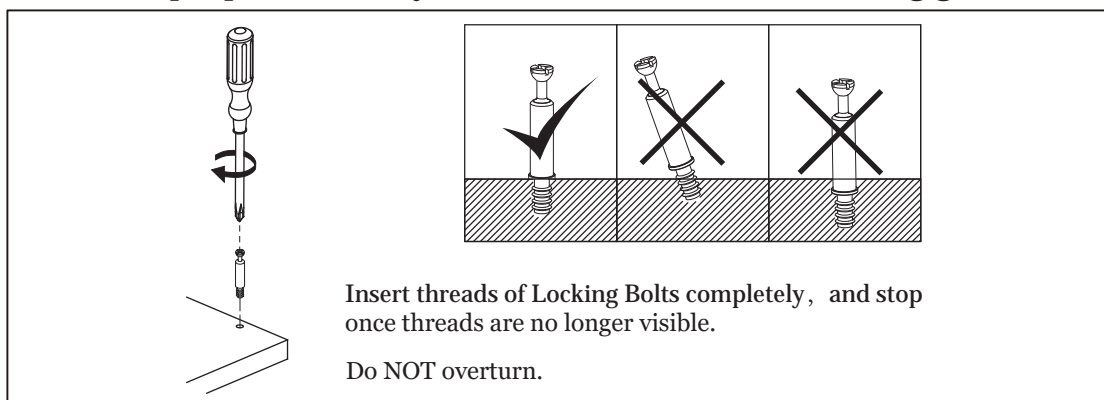

IMPORTANT :

1. Do not tighten bolts / screws completely until all bolts / screws are lined up and inserted into holes.
2. Do not over tighten screws and bolts to avoid stripping.
3. Please use hand tools to assemble this product. Do not use power tools.
4. Must need 2 people to assemble this product.



2 PERSONS

INSTALLATION STEPS



STEP 1

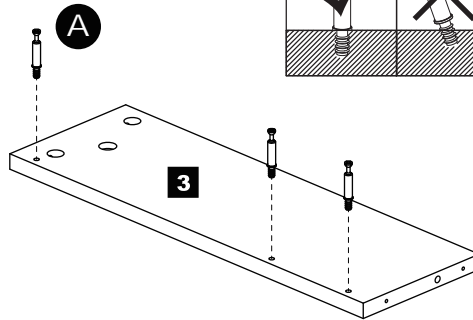
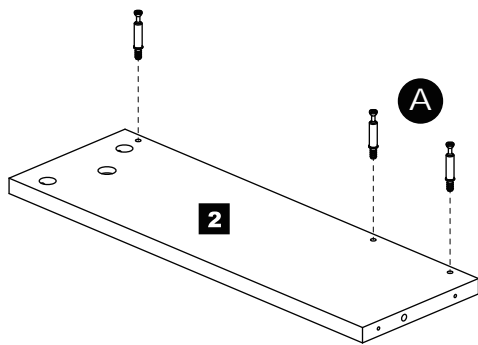
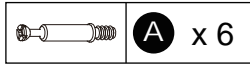

STEP 2

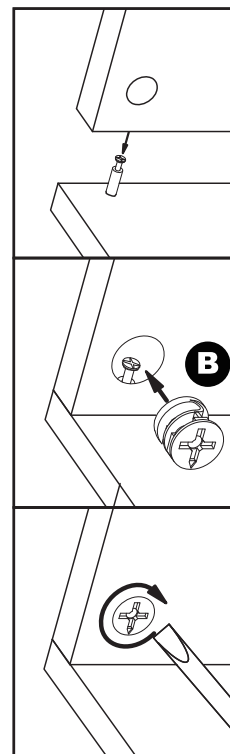
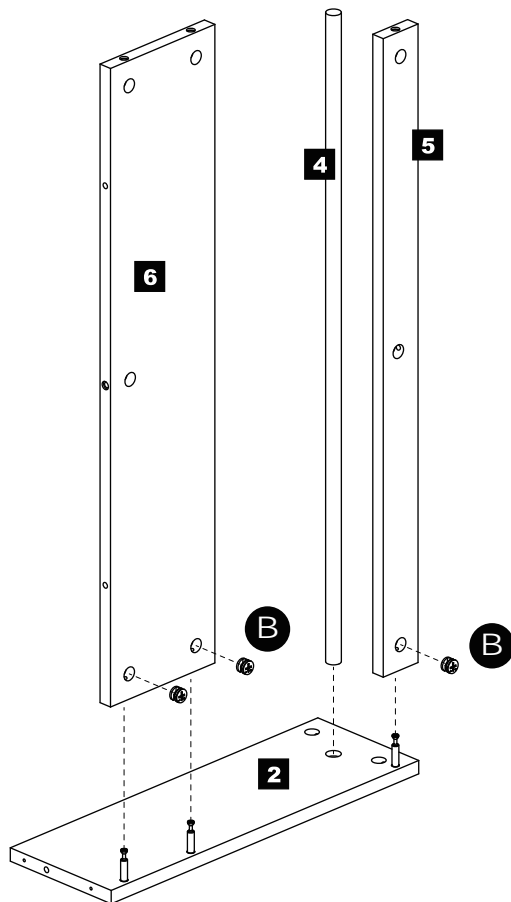

INSTALLATION STEPS



STEP 3



B x 3

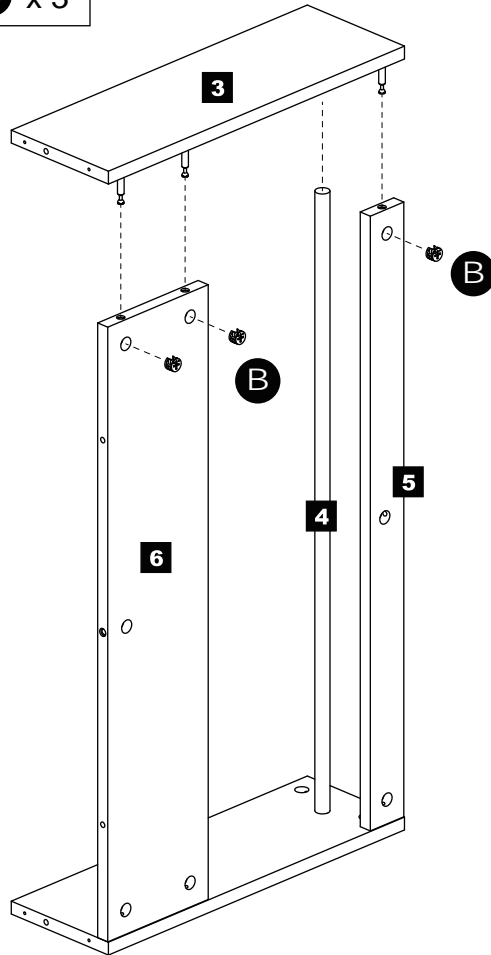

STEP 4

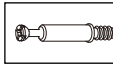

A x 5

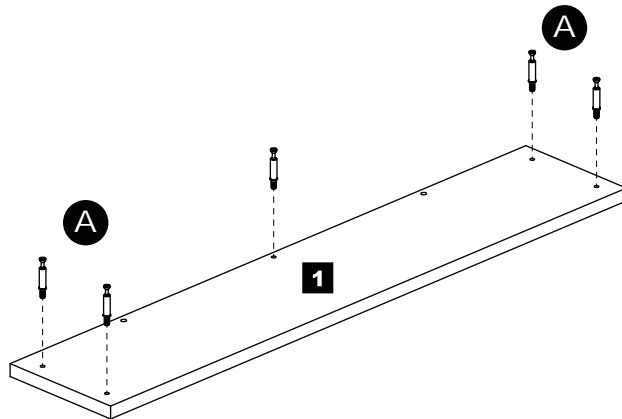

INSTALLATION STEPS



STEP 5

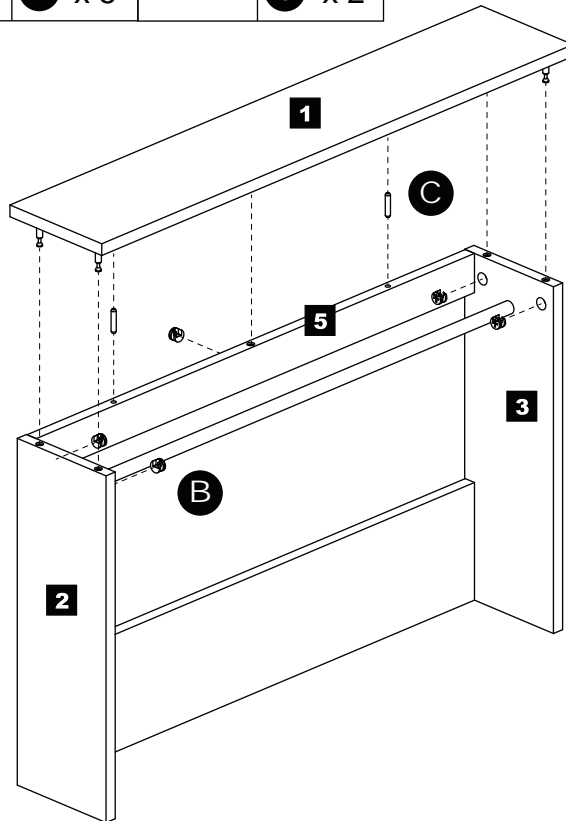

STEP 6

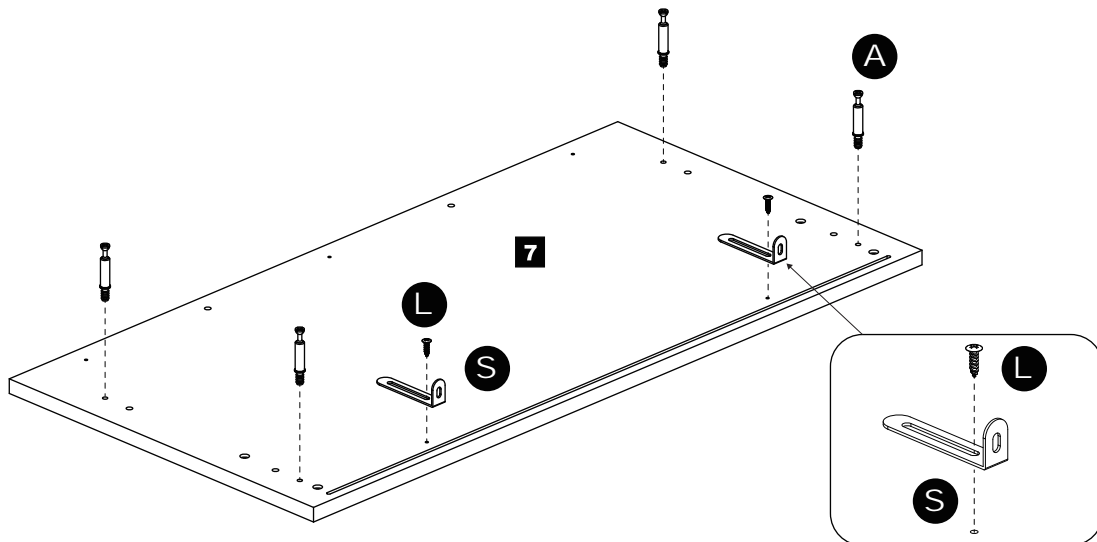

INSTALLATION STEPS



STEP 7

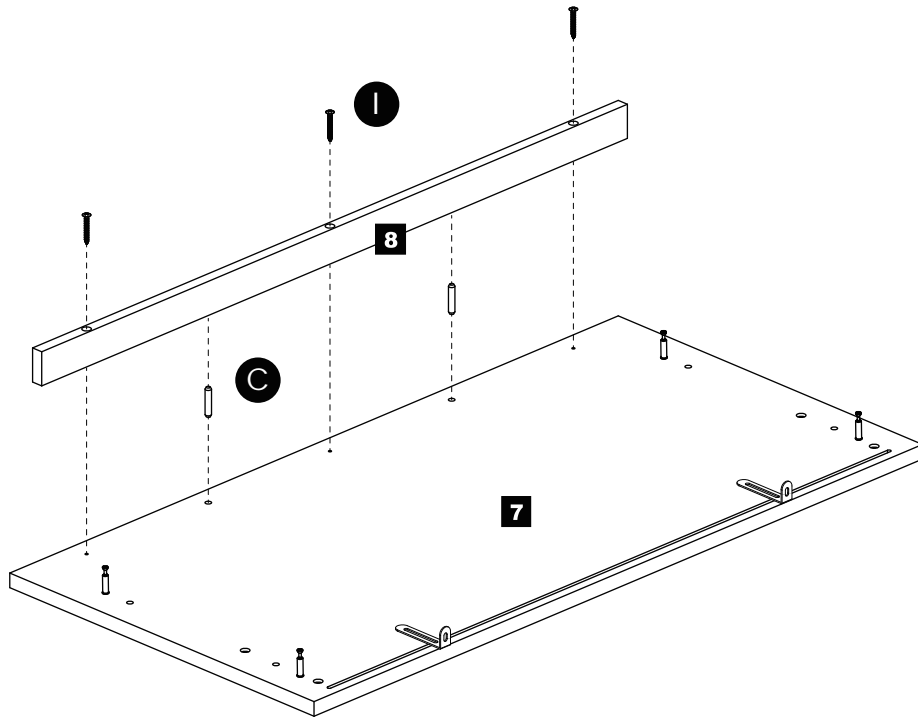

STEP 8

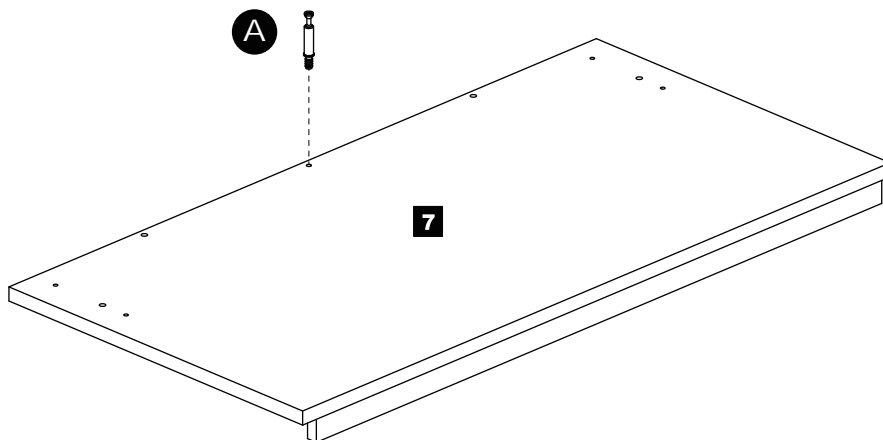
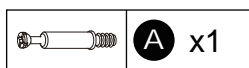

INSTALLATION STEPS



STEP 9

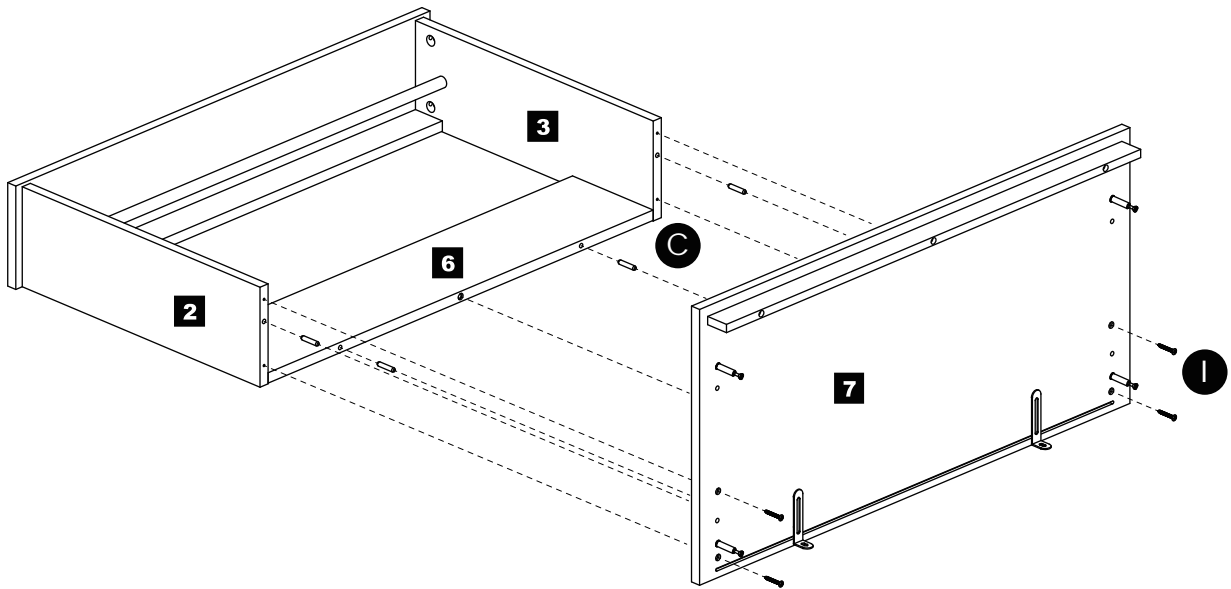

STEP 10

