























# Assembly Instructions

## Care & Maintenance

 	<ul style="list-style-type: none"><li>● Not for commercial use. For residential use only.</li></ul>
 	<ul style="list-style-type: none"><li>● Furniture may scratch floors. We recommend using furniture pads to protect your floors.</li></ul>
 	<ul style="list-style-type: none"><li>● Do not put hot items directly on furniture surface.</li></ul>
 	<ul style="list-style-type: none"><li>● Do not clean furniture with harsh cleansers or polish.</li></ul>
 	<ul style="list-style-type: none"><li>● Do not place furniture under direct sunlight.</li></ul>
 	<ul style="list-style-type: none"><li>● Do not place furniture near heating or cooling vents.</li></ul>
 	<ul style="list-style-type: none"><li>● Do not write on furniture without a padded barrier to protect the surface.</li></ul>
 	<ul style="list-style-type: none"><li>● Do not place furniture outside. For indoor use only.</li></ul>
 	<ul style="list-style-type: none"><li>● Stains may be removed with mild soap solution and damp cloth.</li></ul>
 	<ul style="list-style-type: none"><li>● Children should not climb or jump on the furniture.</li></ul>
 	<ul style="list-style-type: none"><li>● Dust and pick-up spills using a clean, non-colored, lint-free cloth.</li></ul>



Please look in the box for hardware packs and legs.

Sets often ship in multiple boxes and may arrive a day or two apart.

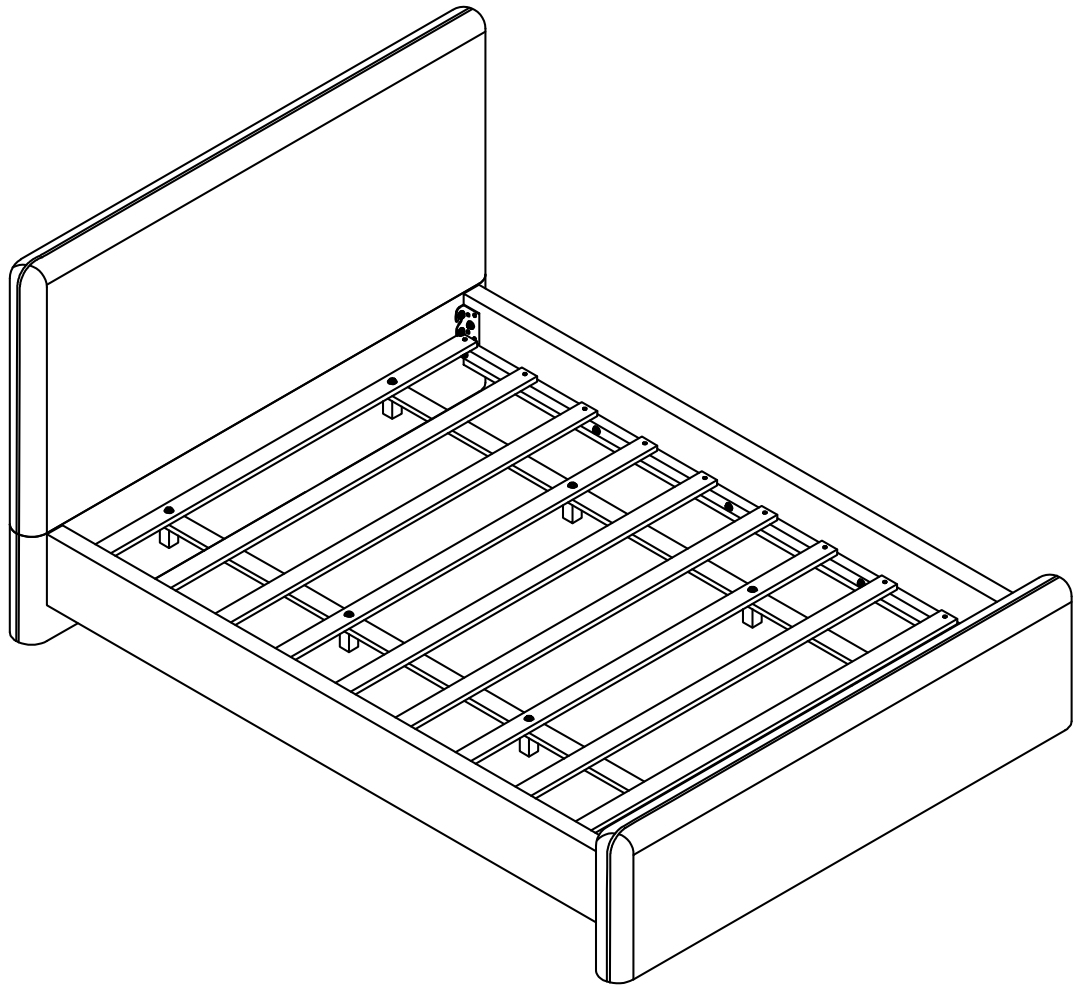
King bed  
N757P442433I



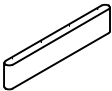

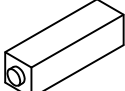
Part List





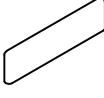

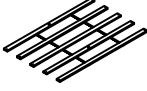
Label	Picture	Description	QTY
②		Headboard Below	1pc
④		Side Rail(R)	1pc
⑤		Side Rail(L)	1pc
⑧		Center Support Leg	8pcs

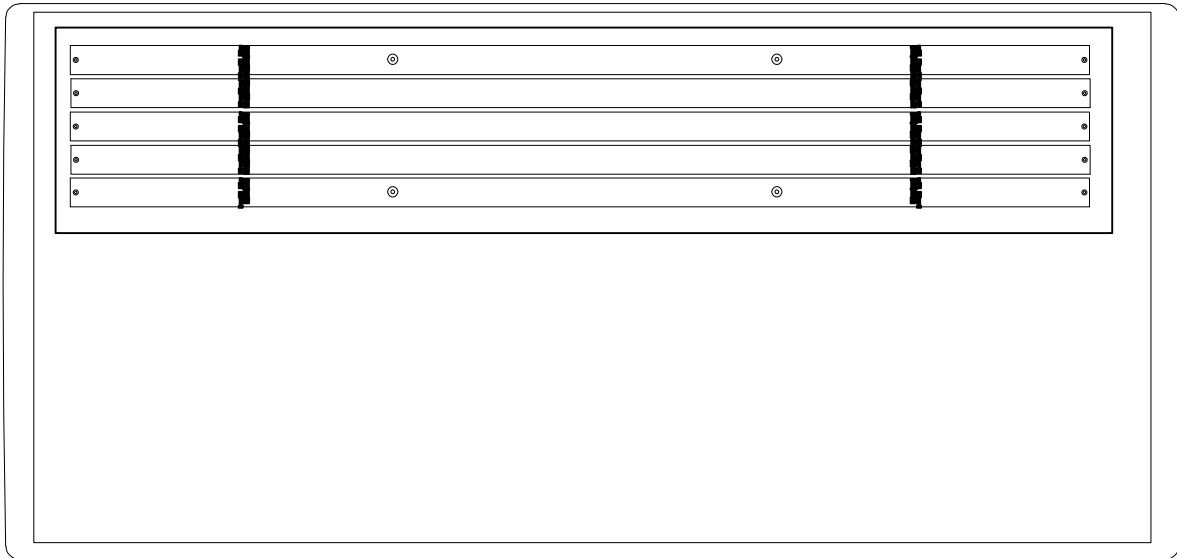
Part List

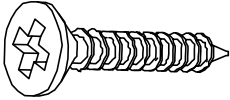
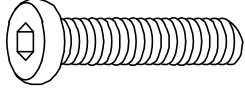
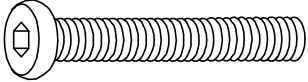
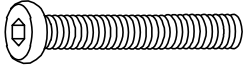
N757P442432I



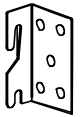
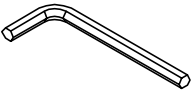

Label	Picture	Description	QTY
①		Headboard	1pc
③		Footboard	1pc
⑥		Support Rail	2pcs
⑦		Middle Support Bar	2pcs
⑨		Slats	2pcs

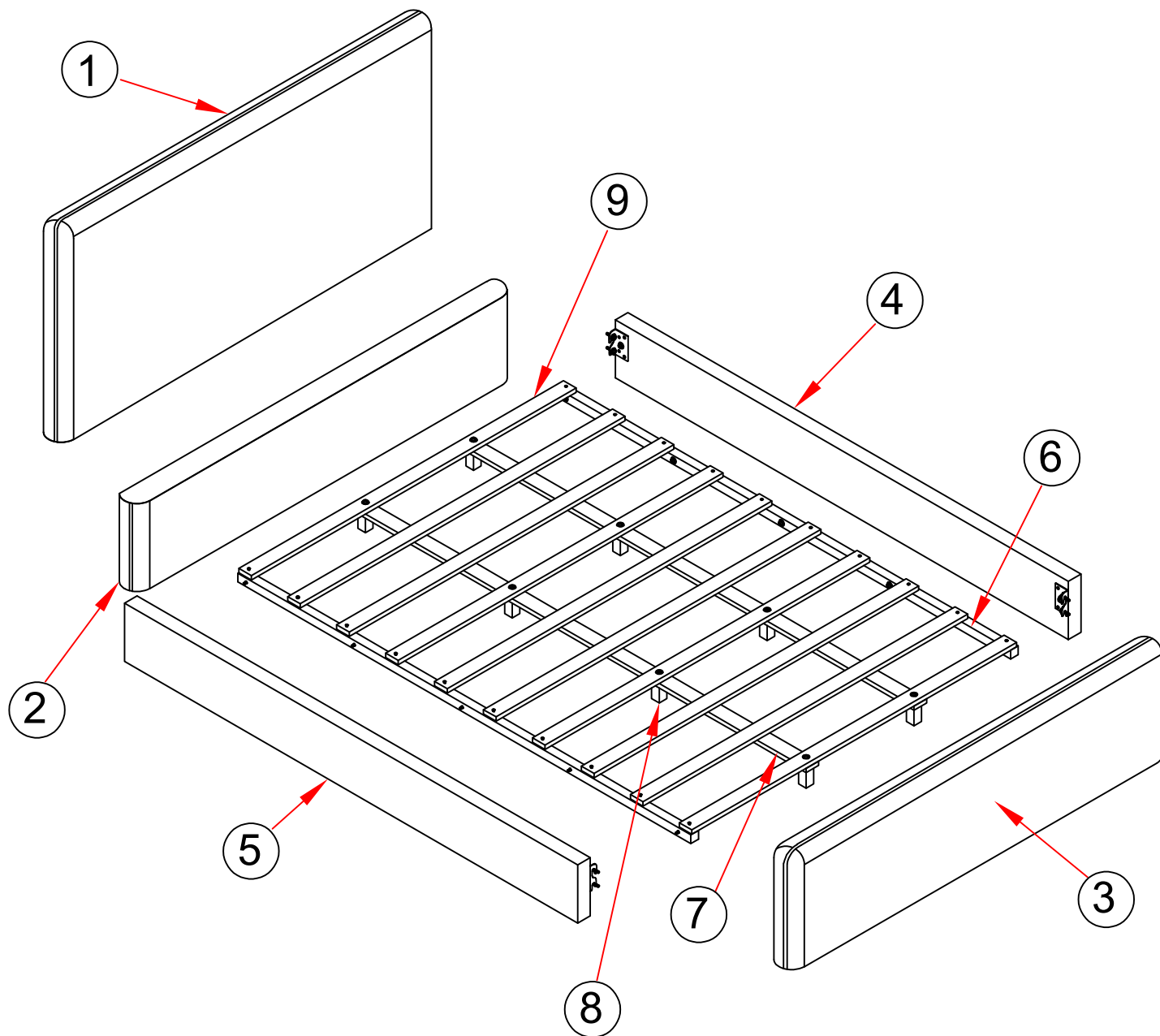

Label	Picture	Description	QTY
A		Screw(4x30mm)	36+1 pcs
B		Bolts(5/16x30mm)	12+1 pcs
C		Bolts(5/16x50mm)	18+1 pcs
D		Bolts(1/4x50mm)	8+1 pcs
E		Lock washer(5/16x20mm)	30+1 pcs
F		Flat washer(5/16x20mm)	30+1 pcs
G		Lock washer(1/4x18mm)	8+1 pcs
H		Flat washer(1/4x18mm)	8+1 pcs
T		Metal pad(L)	2 pcs
K		Metal pad(R)	2 pcs
M		Allen Wrench(M4)	1 pc

# Before Beginning assembly:



-  Read the instructions cover to cover
-  Have 2 adults on hand for assembly
-  Do not assemble on flooring or carpet
-  Assemble on a clean, non-marring surface
-  Save all packaging until finished

## OVERVIEW

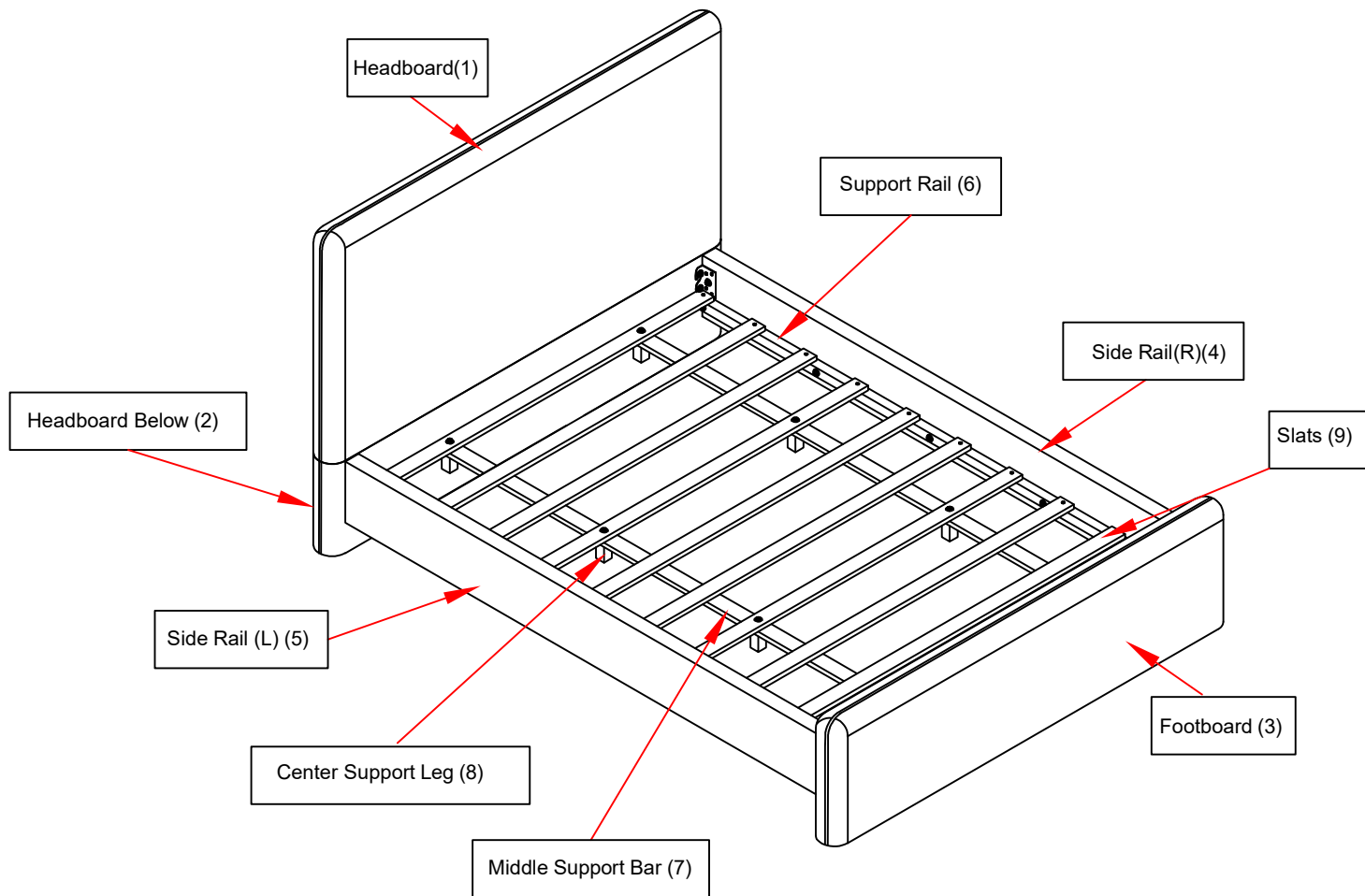

### FRONT FACING / FACE AVANT

-This Bed have multiple parts and may require up to 30 minutes to assemble.  
-To give you an overview of the Bed parts, the above picture is to help you put the various parts into perspective. Please read through the instructions below to familiarise yourself with the parts and steps before assembly.

Note: It is recommended that you have an adult partner to assist during the entire assembly process.

# Step 1

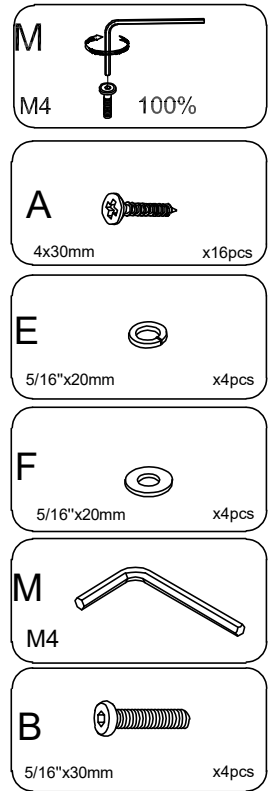
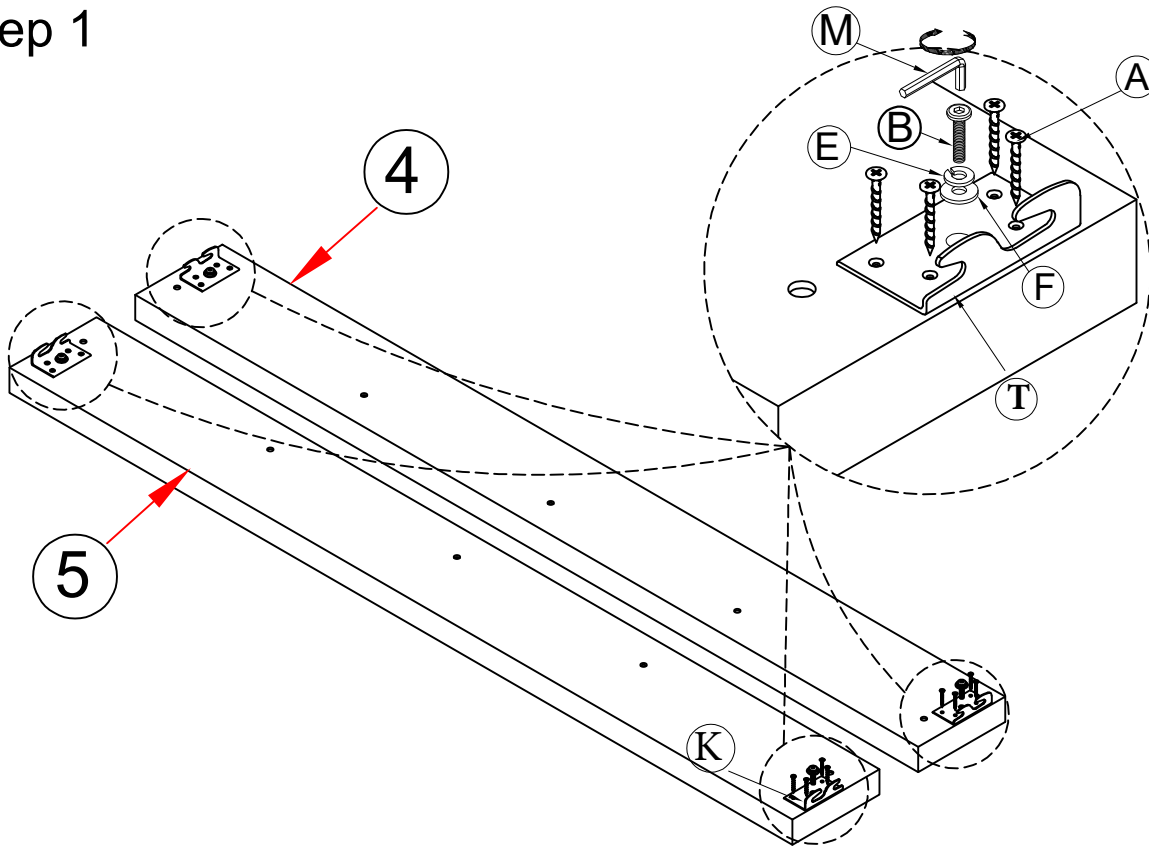

Use 4 Screws (A) to secure the four corners of the bracket.  
 Insert Bolt (B) through Lock Washer (E) and Flat Washer (F), then thread it into the center hole of the bracket.  
 Use the Allen Key (M) to fully tighten (100%) the bolt. Repeat this process for both rails (4) and (5).

# Step 2

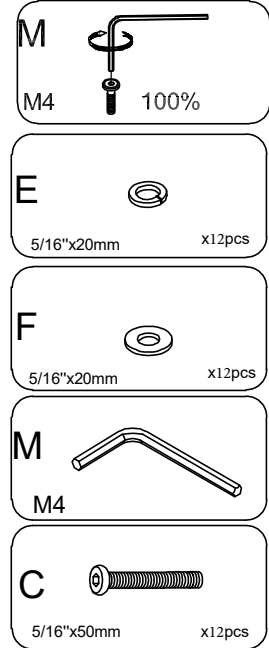
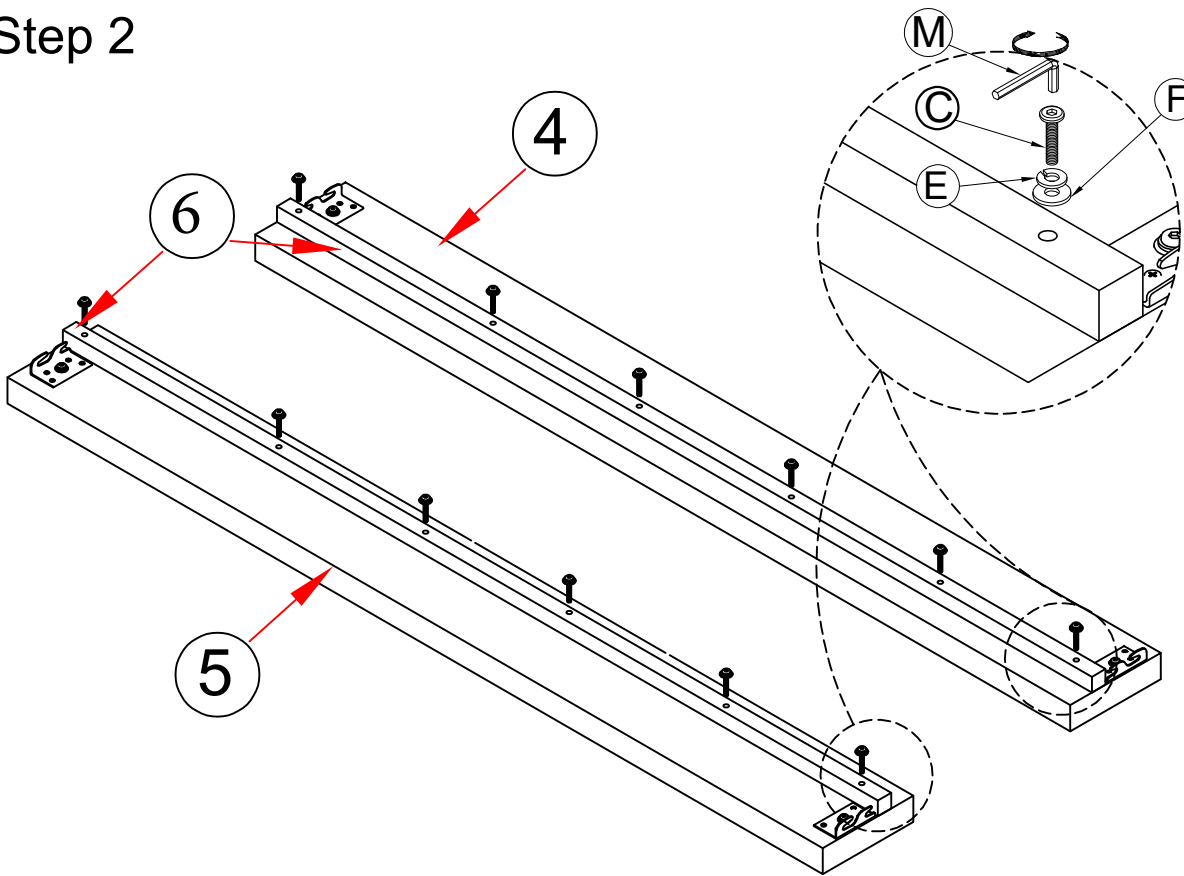

Align the holes on the support rail with the pre-drilled holes on the side rails.  
 Insert Bolt (C) through Lock Washer (E) and Flat Washer (F), then thread it into each hole (5 positions per rail).  
 Use the Allen Key (M) to fully tighten (100%) all bolts.

## Step 4

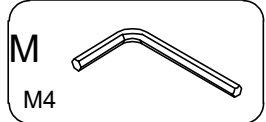
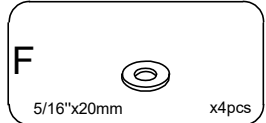
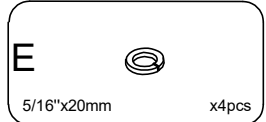
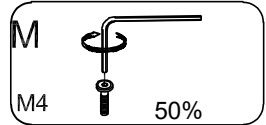
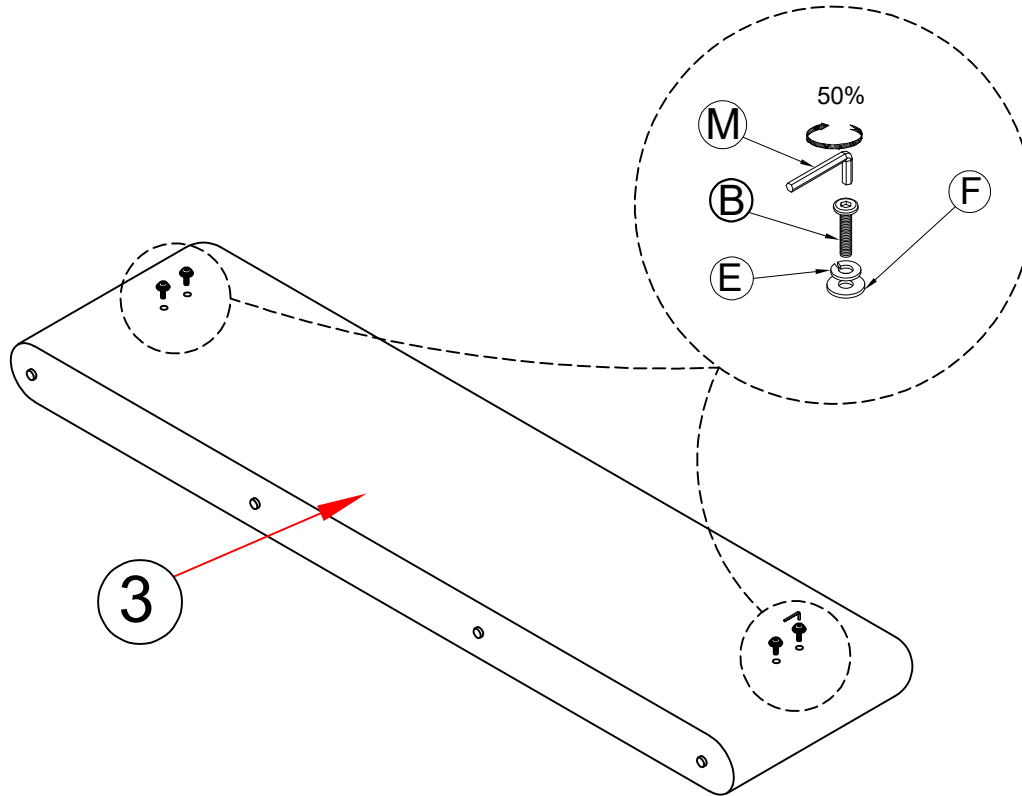

At the 4 pre-drilled holes on both ends of the panel, insert Bolt (B) through Lock Washer (E) and Flat Washer (F), then into the holes. Use the Allen Key (M) to thread the bolts in, but only tighten to 50% (do not fully tighten at this step).

## Step 5

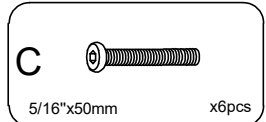
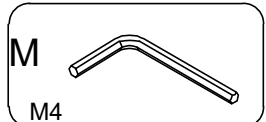
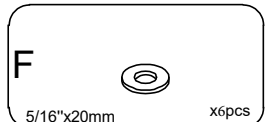
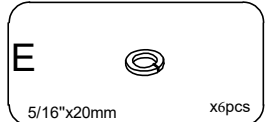
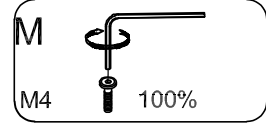
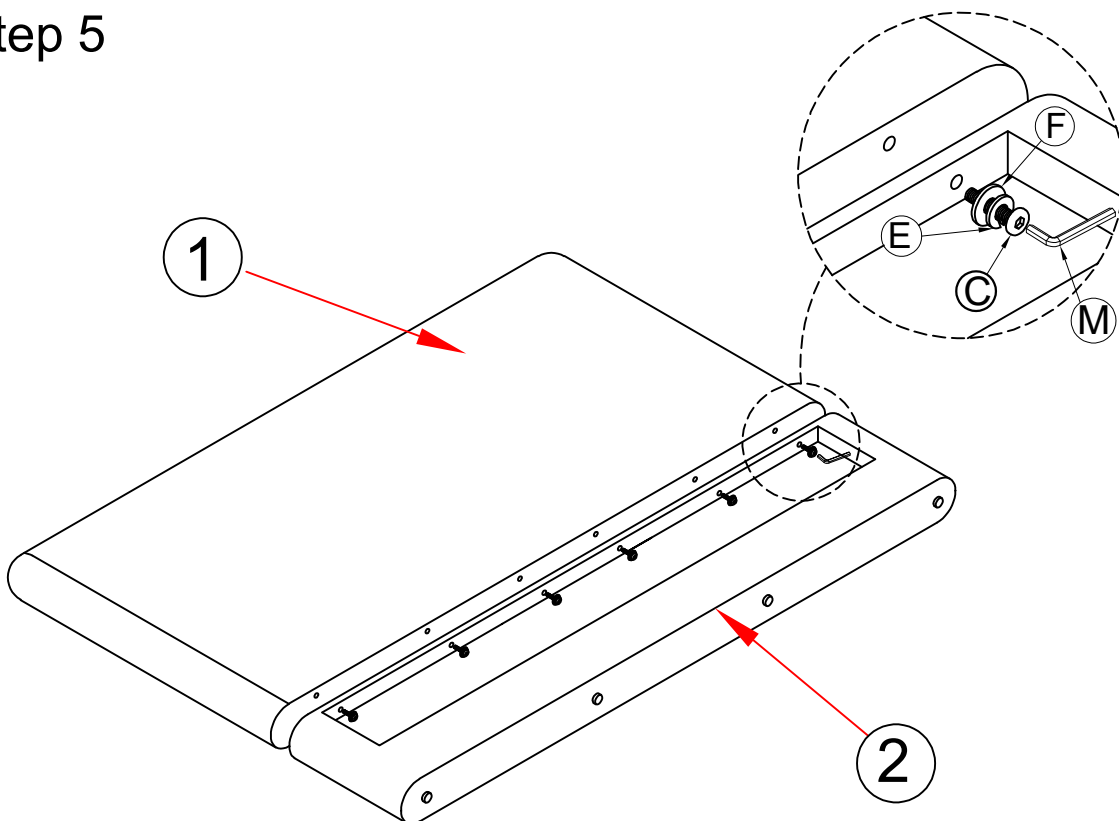

Lay both pieces flat on their front side to easily assemble. Align the pre-drilled holes on piece (2) with the corresponding holes on piece (1). Insert 4 long Bolts (C) through the holes on piece (2). Then place Lock Washer (E) and Flat Washer (F) onto the bolt end. Thread the bolts into the corresponding holes on piece (1). Use the Allen Key (M) to fully tighten (100%) all 4 bolts, securing the two headboard pieces together.

# Step 6

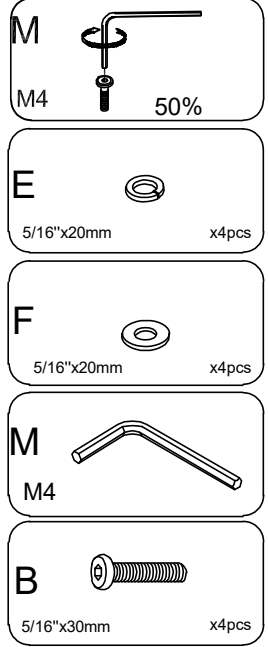
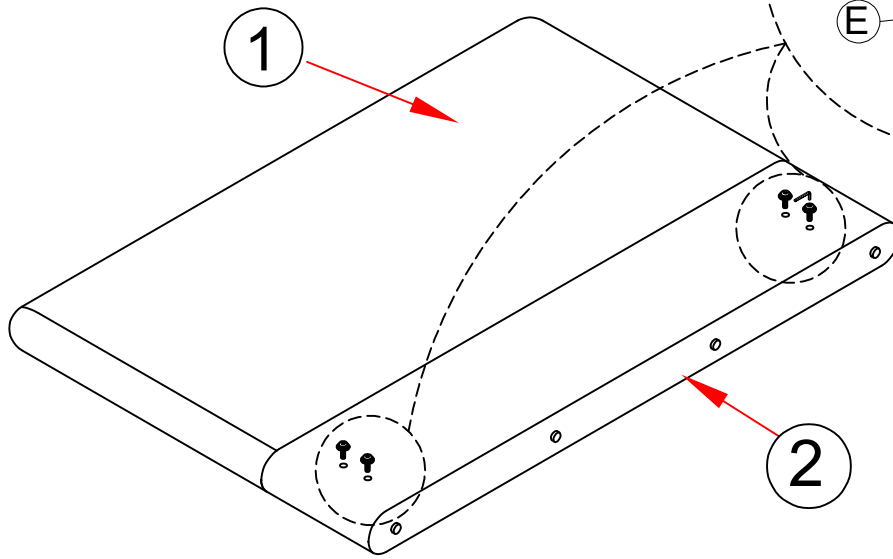

At the 4 pre-drilled holes on both edges of Piece (2), insert Bolt (B) through Lock Washer (E) and Flat Washer (F), then place them into the holes. Use the Allen Key (M) to thread the bolts in, but only tighten to 50% (leave them loose, do not fully tighten at this step).

# Step 7

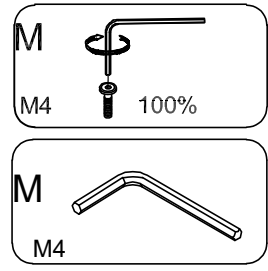
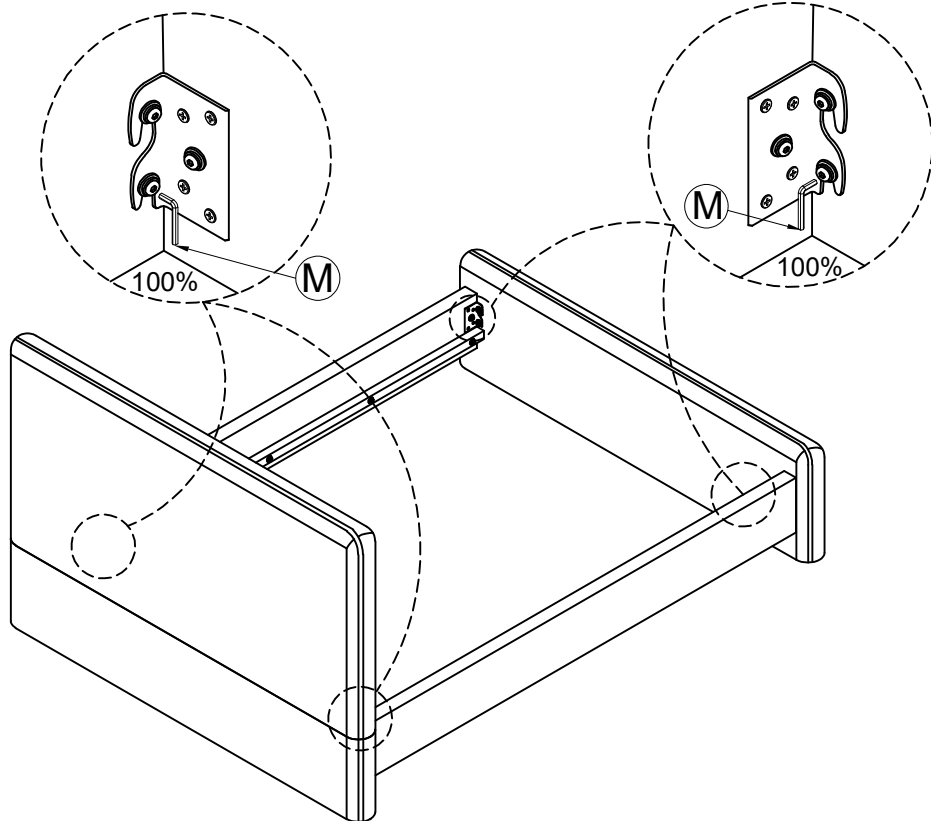

Lift the side rail and slide the metal hooks onto the bolts that were left 50% loose on the lower headboard (Piece 2). Push down slightly to ensure the hooks drop securely into place. Use the Allen Key (M) to fully tighten (100%) these bolts, locking the side rails to the headboard.

## Step 8

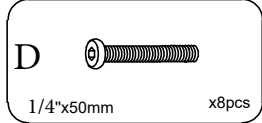
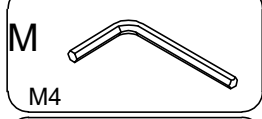
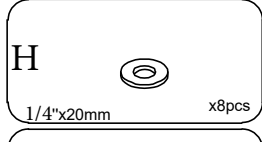
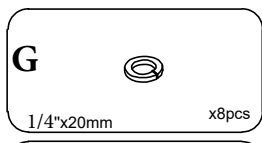
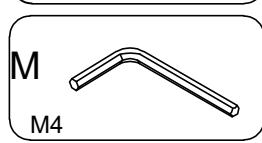
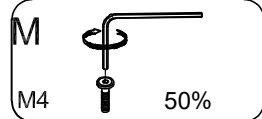
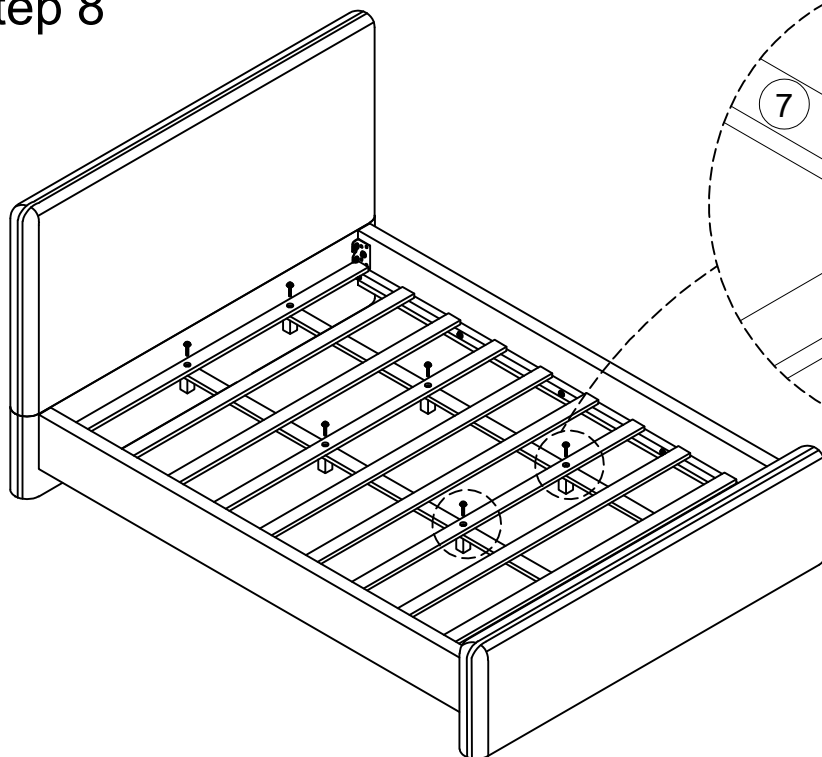

Lay the horizontal slats (9) across the longitudinal center support bar (7). Position the support leg (8) underneath at the intersection so the holes align.

Insert Bolt (C) through Lock Washer (E) and Flat Washer (F), then thread it from the top of the slat (9) down into the support leg (8).

Use the Allen Key (M) to thread the bolts in, but only tighten to 50% (leave them loose for now). Repeat this process for all 4 center support leg positions.

## Step 9

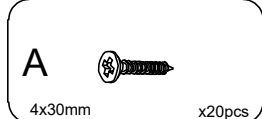
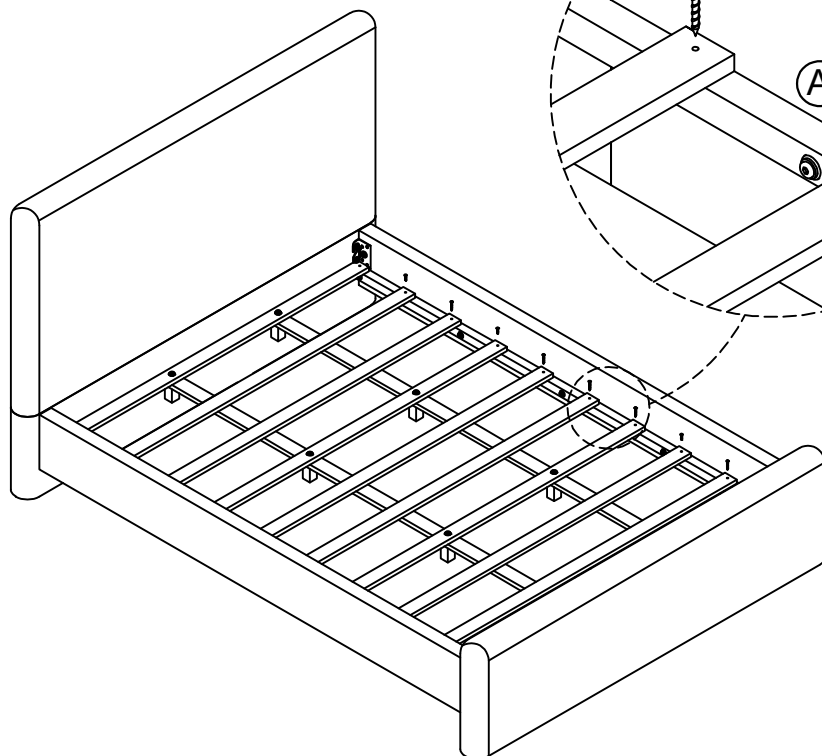

Spread the bed slats evenly so that both ends rest on the support cleats along the inside of the side rails.

Use Screws (A) through the pre-drilled holes at both ends of each slat and drive them down into the support cleat. (A total of 20 screws are needed).

Use a screwdriver (usually not included, self-provided) to fully tighten all these screws.

# Step 10

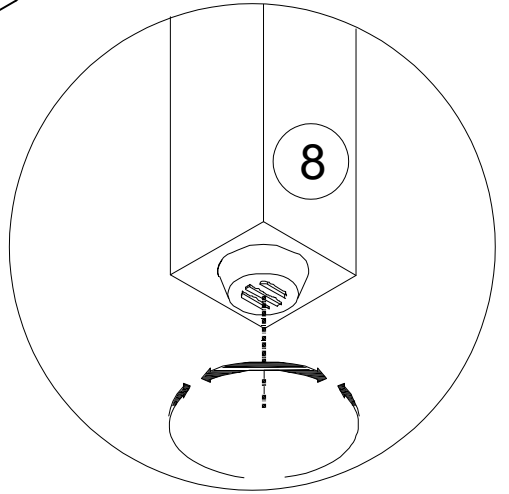
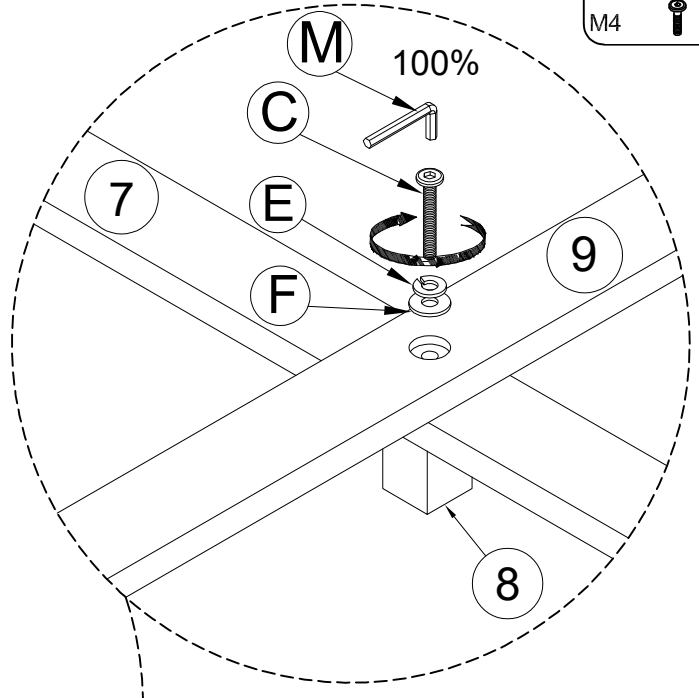
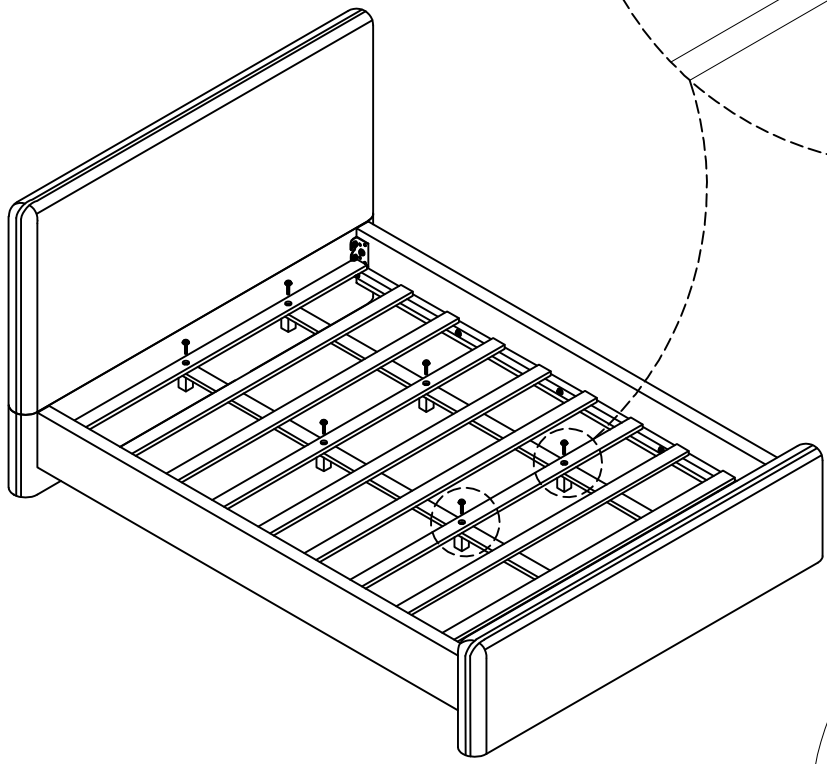
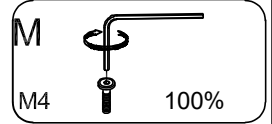

Return to the 4 center support legs (8) where the bolts were left 50% loose in Step 8. Use the Allen Key (M) to fully tighten (100%) all Bolts (C), securing the slats (9) to the center support bar (7) and legs (8).

Finish

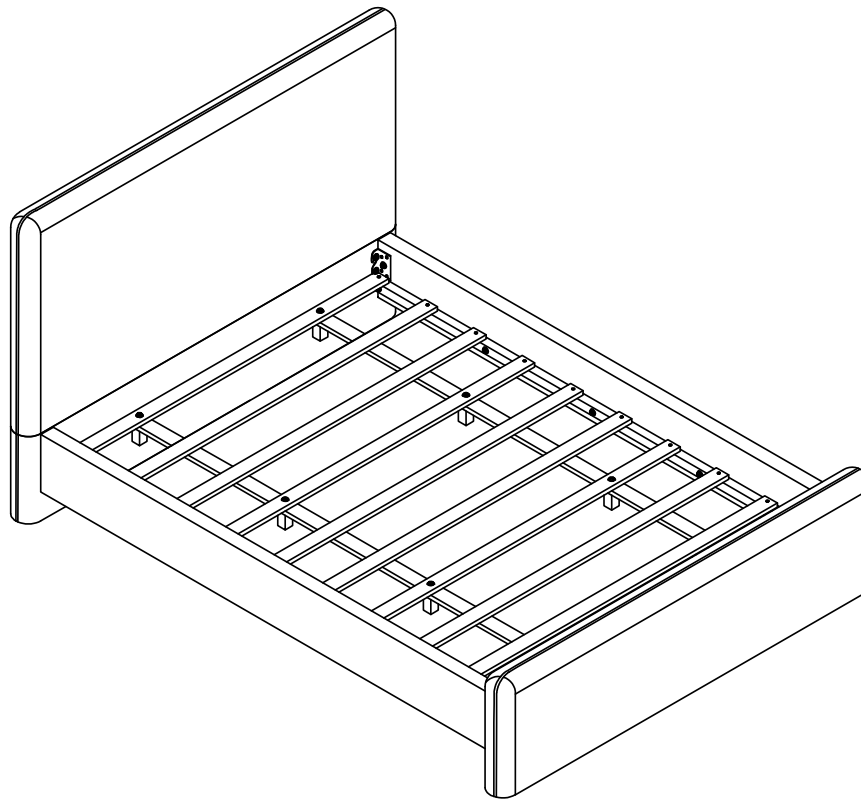

Thank you for your trust and preference in using our products.  
The product will bring you a peaceful sleep forever

Place the Bed on a LEVEL SURFACE.

Inspect it and make sure all parts are adequately connected. Don't push too hard, shake on the bed.

This would help to align all the parts at the joint areas. CAUTION 1: When tightening these screws, tighten sequentially. DO NOT tighten any screws fully and then towards the next one. This would cause the frame to warp.

If there is still wobbles, loosen the screws and execute this same process.

DO NOT tighten any screws fully and then towards the next one.

WARNING: IF BED IS NOT STABLE, IT COULD LEAD TO DAMAGING THE PRODUCT.

Ensure all screws are fully locked into position.

The bed is ready to be used.

CAUTION 2: This bed can only be used on a flat, level surface.