

ASSEMBLY INSTRUCTIONS

TEAKWOOD END TABLE (ATF27)

STEP 1

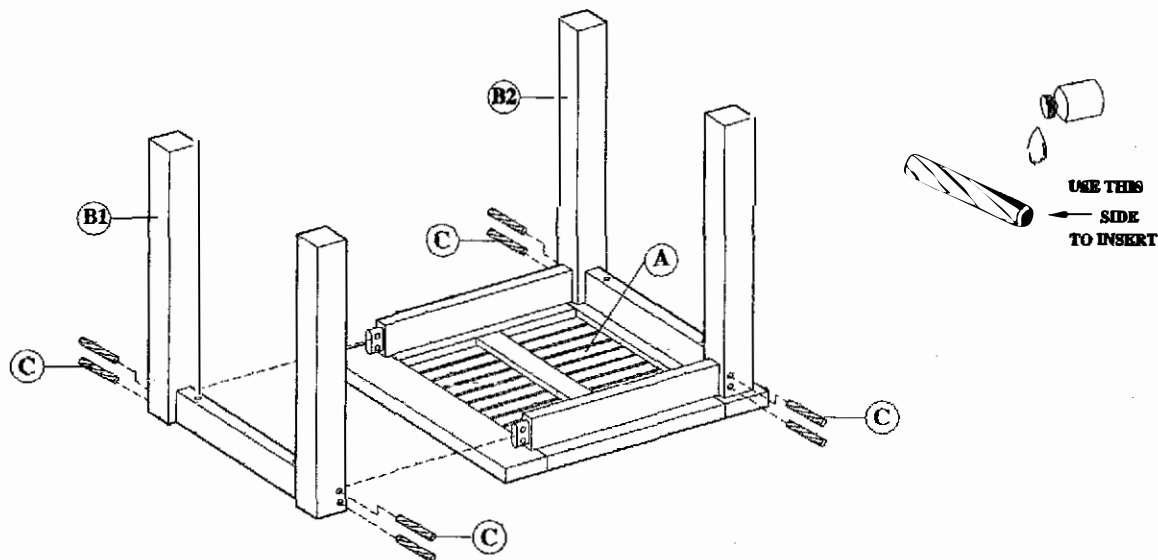

STEP 2

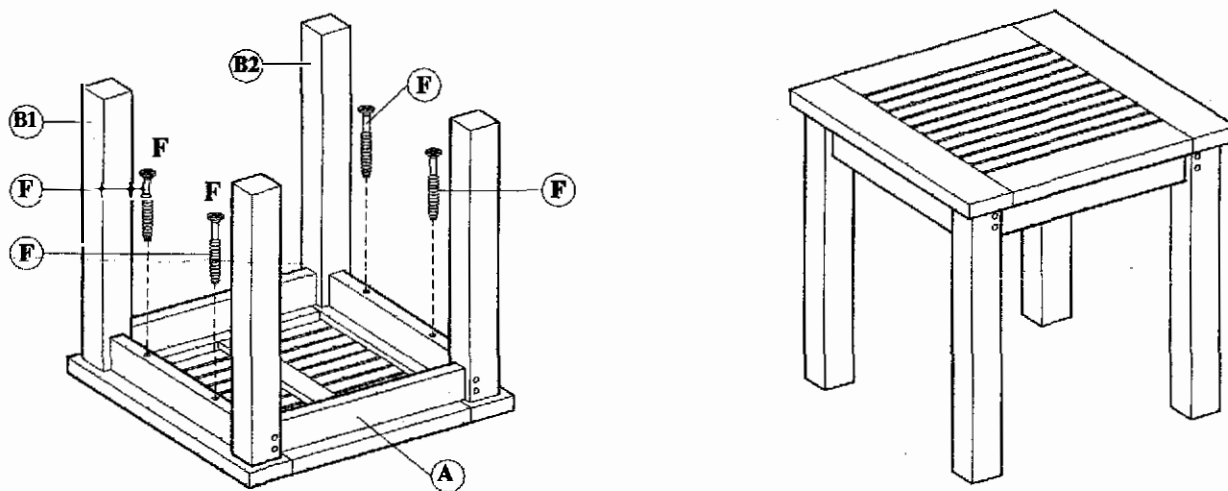

NO	PARTS		QTY.
A	TABLE TOP		1
B1,B2	LEGS		2
C	DOWEL		8+2
D	SANDPAPER		1
E	GLUE		1
F	SCREW		4