

ASSEMBLY INSTRUCTION

MODEL NAME: FUSION FABRIC BED IN BOX

IMPORTANT

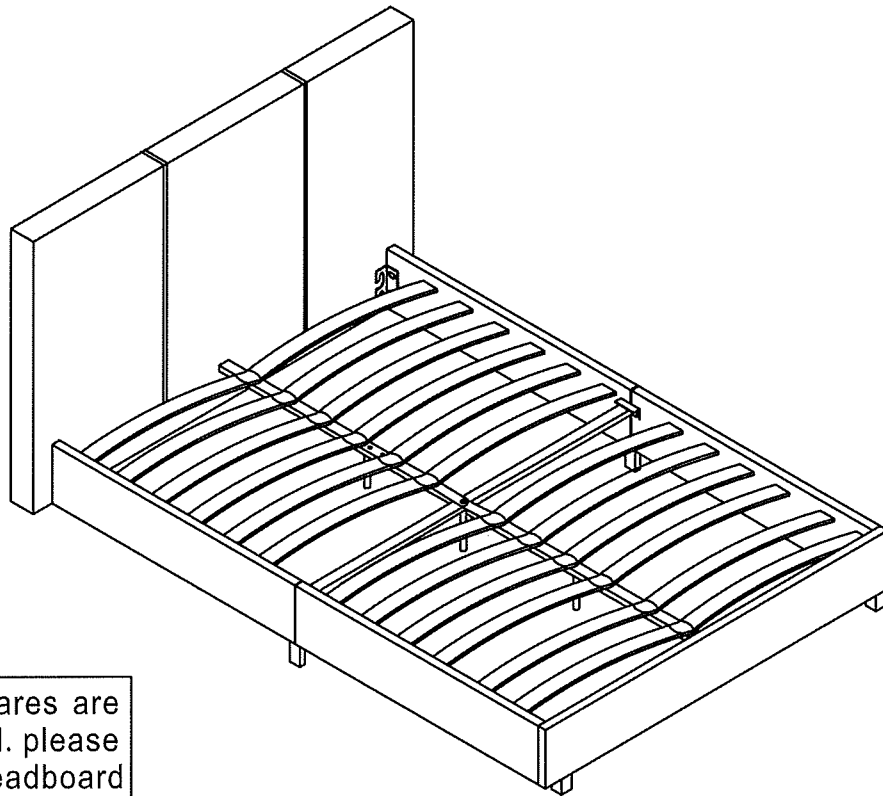









Please inspect all items carefully before assembling.
If for any reason you need to return this item, you must return it in its original packaging.
Assembled items cannot be returned.

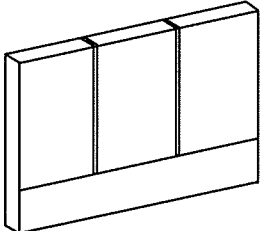

Parts and hardware are inside headboard. please open zip from headboard

HELPFUL ADVICE PRIOR TO ASSEMBLING THE BED

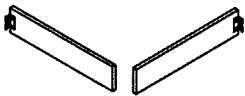
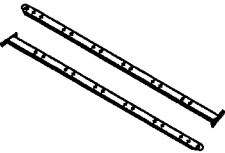
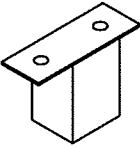
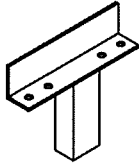
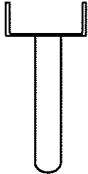
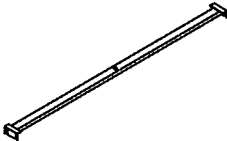
- 1)Owing to the size and weight of the bed, we recommend that it is assembled by two adults, on a flat surface, in the room that it is intended for.
- 2)Please do not use any tools other than those provided or recommended in these instructions.
- 3)Please do not discard any packaging until you have checked that you have all the parts and fittings. keep all fittings out of reach of children.
- 4)Assemble all parts loosely until advised to tighten. Depending on use, it may be necessary to tighten the fittings from time to time, so please save your allen key and spanner that has been provided.

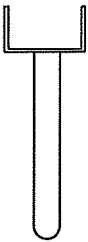
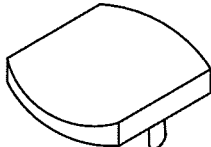
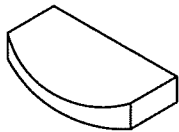
<p>Ⓐ 8PCS-Bolt M8*25mm</p> 	<p>Ⓑ 25PCS-Bolt M6*15mm</p> 	<p>Ⓒ 3PCS-Bolt M6*30mm</p> 
<p>Ⓓ 8PCS-Flat Washer</p> 	<p>Ⓔ 8PCS-Spring Washer</p> 	<p>Ⓕ 1PCS-Allen Key 5mm</p> 
<p>Ⓖ 2PCS-Allen Key 4mm</p> 		
<p style="text-align: center;">Hazard Warning! Keep small components out of the reach of children</p>		
<p>① 1PCS-Headboard</p> 	<p>② 1PCS-Footboard</p> 	<p>③ 4PCS-Side Rail</p> <p style="text-align: center;">2PCS 2PCS</p> 
<p>④ 2PCS-Centre support rail</p> 	<p>⑤ 4PCS-Leg</p> 	<p>⑥ 2PCS-Side rail support leg</p> 
<p>⑦ 1PCS-Centre support leg</p> 	<p>⑧ 1PCS-Horizontal support rail</p> 	<p>⑨ 24/28PCS-Bent Slat</p> 
<p>⑩ 2PCS Long Centre support leg</p> 	<p>⑪ 12/14PCS-Plastic slat cap</p> 	<p>⑫ 24/28PCS- and plastic cap</p> 

STEPS:--

1) Fix the legs(5) to headboard(1) and footboard(2) using bolts(B) as shown. Tighten the bolts using allen key(G).

2) Attach side rail support legs(6) to side rails(3) using bolts(B) as shown. Tighten the bolts using allen key(G).

3) Fix the side rails(3) to headboard(1) and footboard(2) using bolts(A), spring washer(E) and flat washer(D) as shown . Tighten the bolts using allen key(F).

4) Attach horizontal support rail(8) to side rails(3) using bolts(B) as shown. Tighten the bolts using allen key(G).

5) Attach Long centre support legs(10) to centre support rails(4) using bolts(B) and Long nuts(C) as shown. Tighten the bolts using allen key(G).

6) Attach the centre support rails (4) to the headboard (1) and footboard (2) using bolts (B).

7) Place bracket(1) in the mid of horizontal rail(8) ,slot in the centre support rails (4) to Long bracket ,and attach by using bolts(C) and Long nuts(4) as shown.

Fix the centre support legs(7) to horizontal support rail(8) using bolts (C) as shown . Tighten all bolts using allen key(G).

8) First the and plastic cap (12) set to eds (9) and then insert two, slot in the bent slats (9) to side rails (3) pre-holes and then attach bent slats (9) with plastic slat cap (11) to centre support rails (4) as shown.

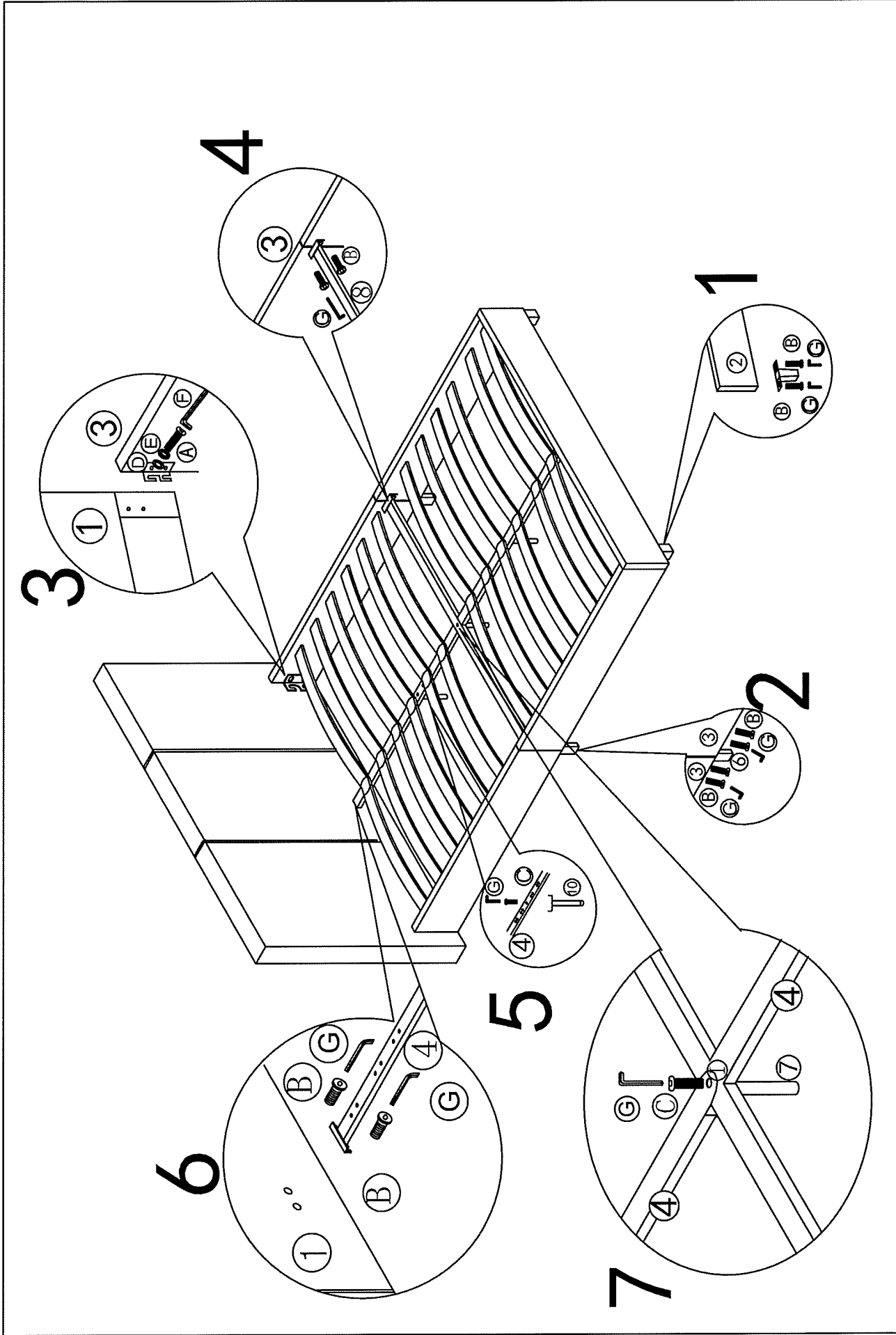

8

