

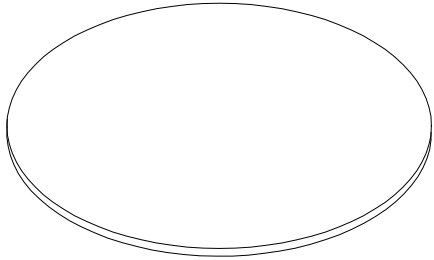

THEODORE ALEXANDER

# WRC54019 ASSEMBLY INSTRUCTION

**P1** Top (x1)



**P2** Base (x1)

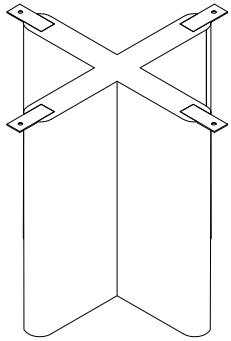

**01** Steel allen bolt & washer (x4)

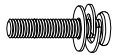

**02** Steel allen wrench (x1)

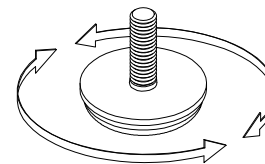
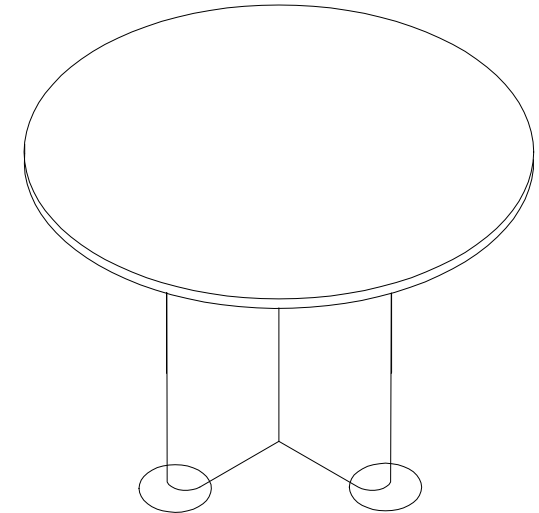
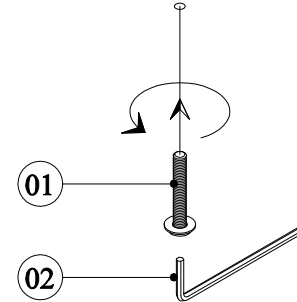
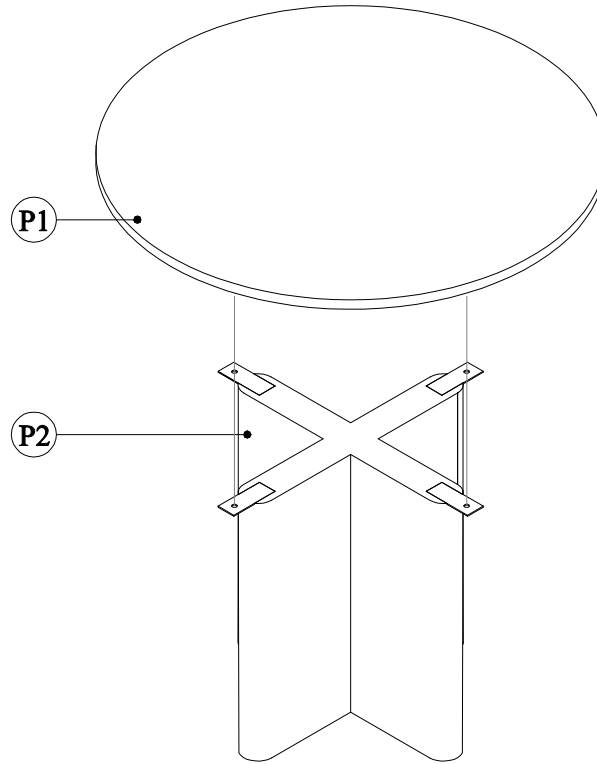

Detail 'B'