

Assembly Instructions

Caution: You must read this before you proceed

Please look underneath the Seat Panel for hardware packs.

Armchair

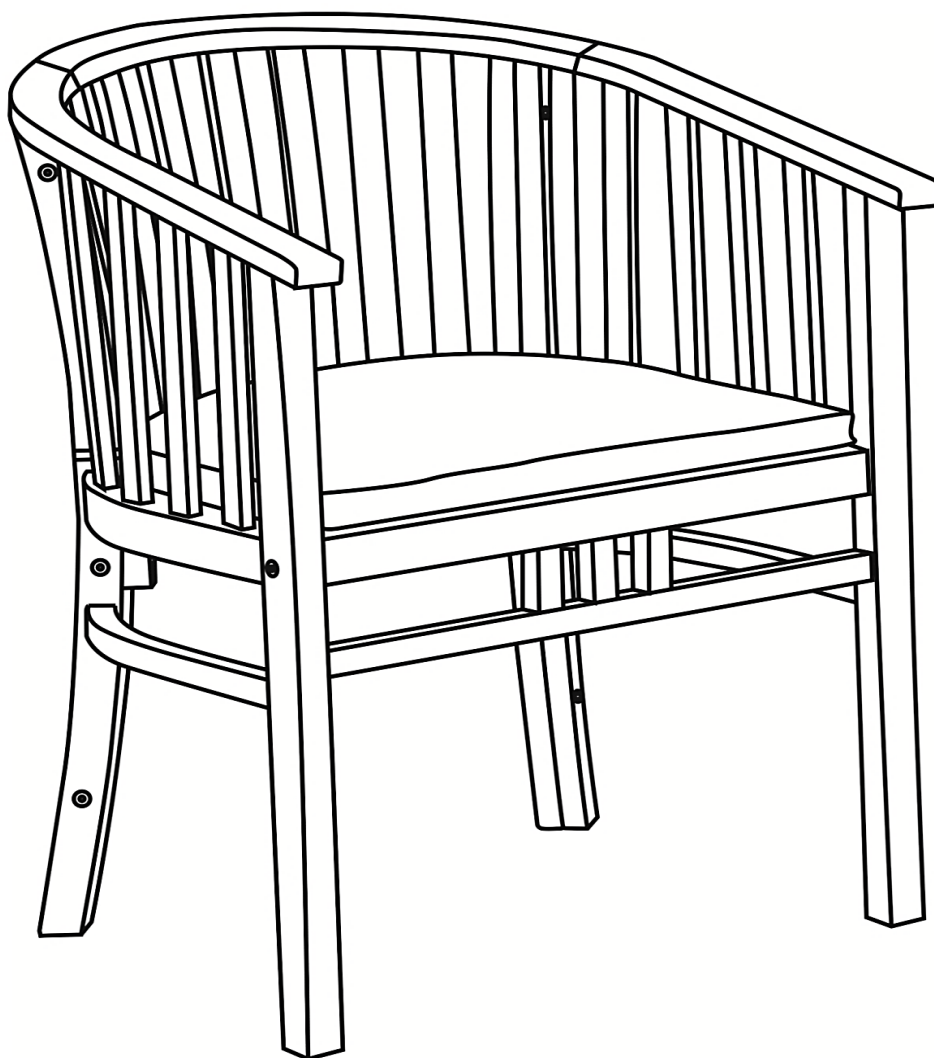





Caution: This Chair is NOT a TOY

Keep your child / children at bay during the assembly process.



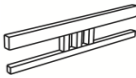
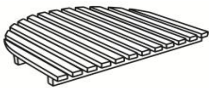





Whenever moving / lifting the Chair and to prevent damage to the Chair two adults are needed to execute these actions

Part List

Label	Picture	Description	QTY
A		Left Arm Panel	1
B		Backrest Panel	1
C		Right Arm Panel	1
D		Leg Support Bar	1
E		Seat Panel	1
F		Seat Cushion	1

Hardware

Note: A small Bolt (⑦) will be used to guide in the Cross Nut (③) and Bolt (②).
This Bolt is to be kept with Allen Key as spare Hardware.

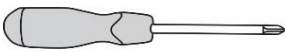
Label	Picture	Description	QTY
①		Bolt (M6x30mm)	7
②		Bolt (M6x80mm)	3
③		Cross Nut (M6x13mm)	3
④		Sleeve Nut (M6x18mm)	7
⑤		Screw (M4x30mm)	4
⑥		Screw (M4x20mm)	3
⑦		Bolt (M6x40mm)	2
⑧		Allen Key	2
⑨		Screwdriver (not provided)	1

Assembly Preparation

Before Beginning Assembly:

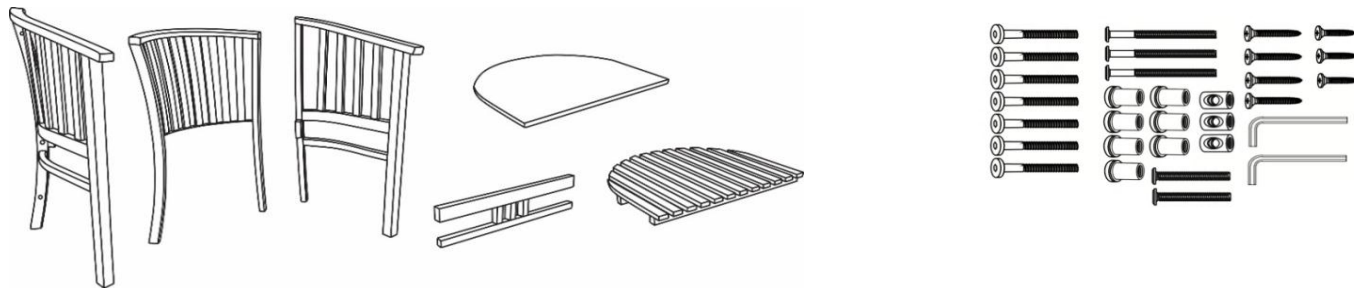

• Read instructions, cover to cover-



• Have 2 adults on hand for assembly-



• Do not assemble on flooring or carpet-



• Assemble on a clean non-marring surface (packing foam)-



• Save all packaging until finished-

Assembly Steps

Overview

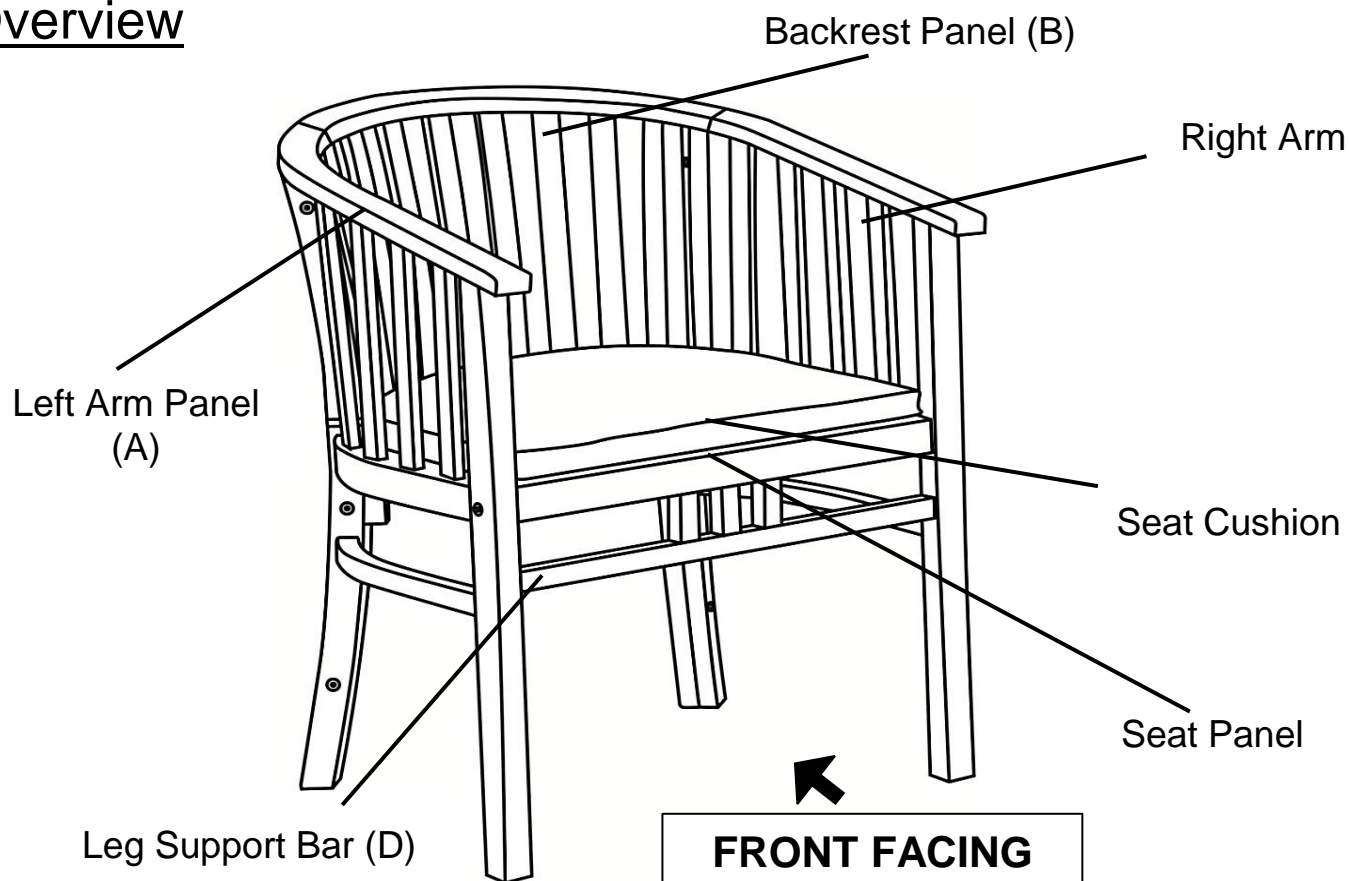

This Armchair has multiple parts and may require up to 30 minutes to assemble. To give you an overview of the Armchair parts, the above picture is to help you put the various parts into perspective. Please read through the instructions below to familiarise yourself with the parts and steps before assembly.

Step 1

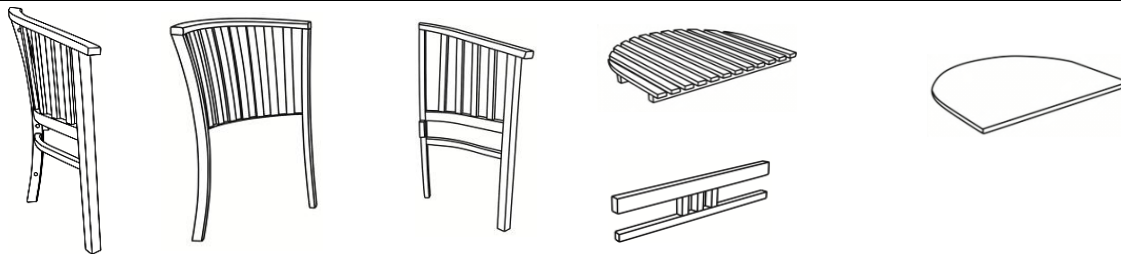

Unpack and place all parts on a clean, non-marring surface.

Step 2

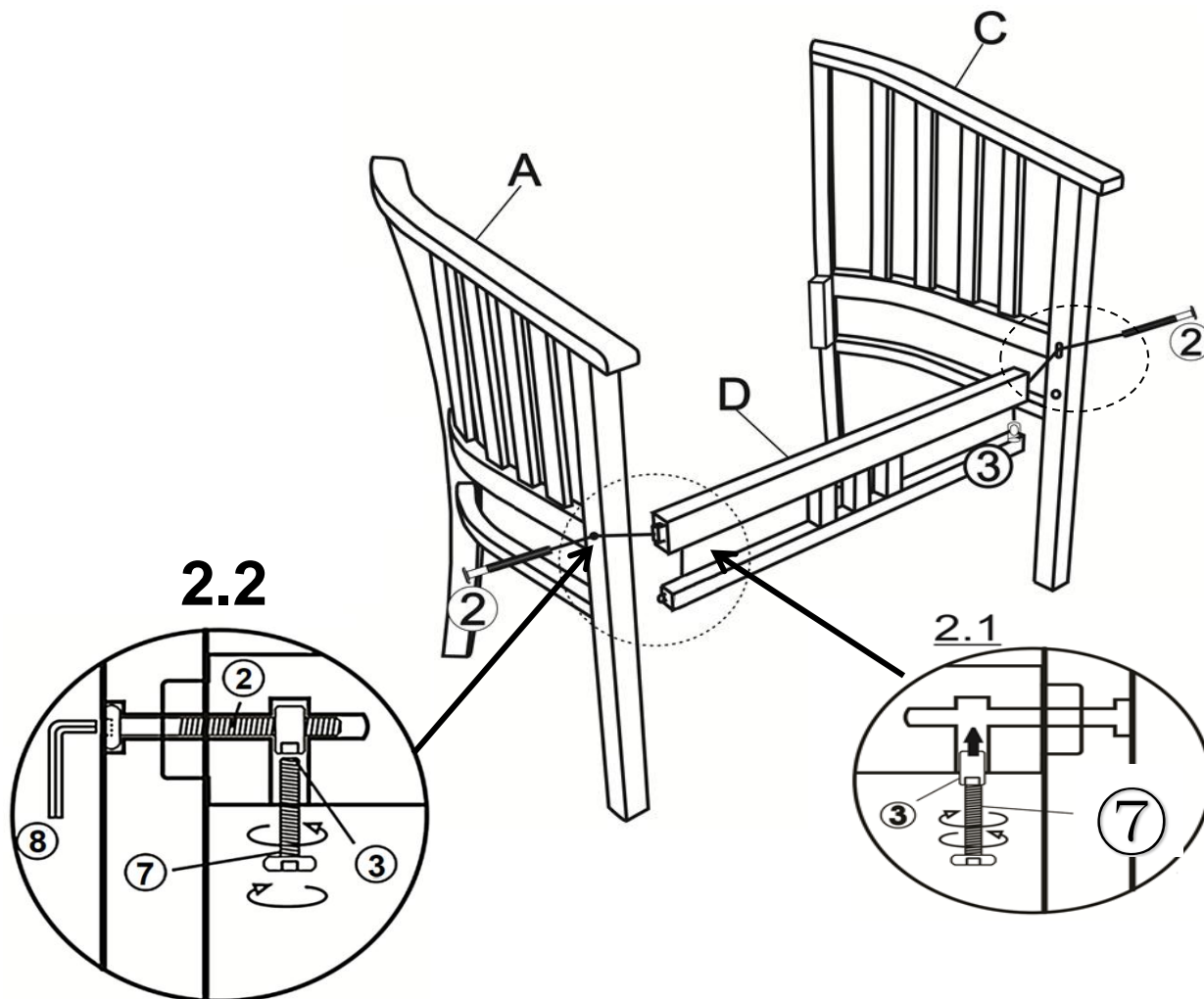

Insert the tenons on Leg Support Bar(D) into the mortises on Left Arm Panel(A).

2.1) Insert Bolt(⑦) into Cross Nut(③), then insert the Cross Nut(③) into the housing on Leg Support Bar(D) as shown above.

2.2) Attach the Left Arm Panel(A) to Leg Support Bar(D) using Bolts(②) with Allen Key(⑧) as pictured.

Note: Affix the Bolt(②) into the Cross Nut(③) inside the Leg Support Bar(D) then remove the Bolt(⑦) from the Cross Nut(③) using Allen Key(⑧).

Repeat the same process to attach the Right Arm Panel(C) to Leg Support Bar(D).

Do not fully tighten the Bolts.

Caution: At the same time, please don't place your hands between the gaps to avoid injury.

Step 3

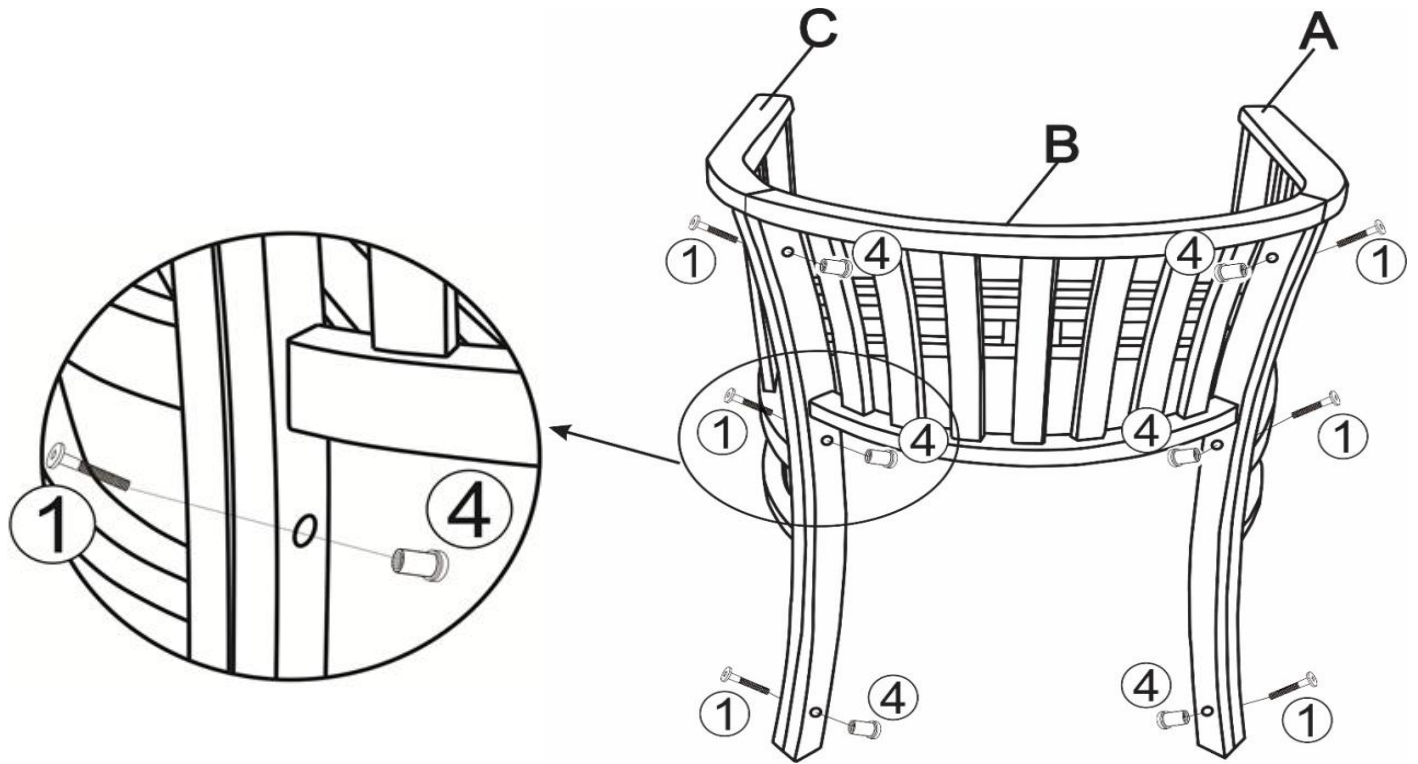

Attach Backrest Panel(B) to Left Arm Panel(A) and Right Arm Panel(C) using Bolts(①) and Sleeve Nuts(④) with Allen Keys(⑧).

Do not fully tighten the Bolts.

Step 4

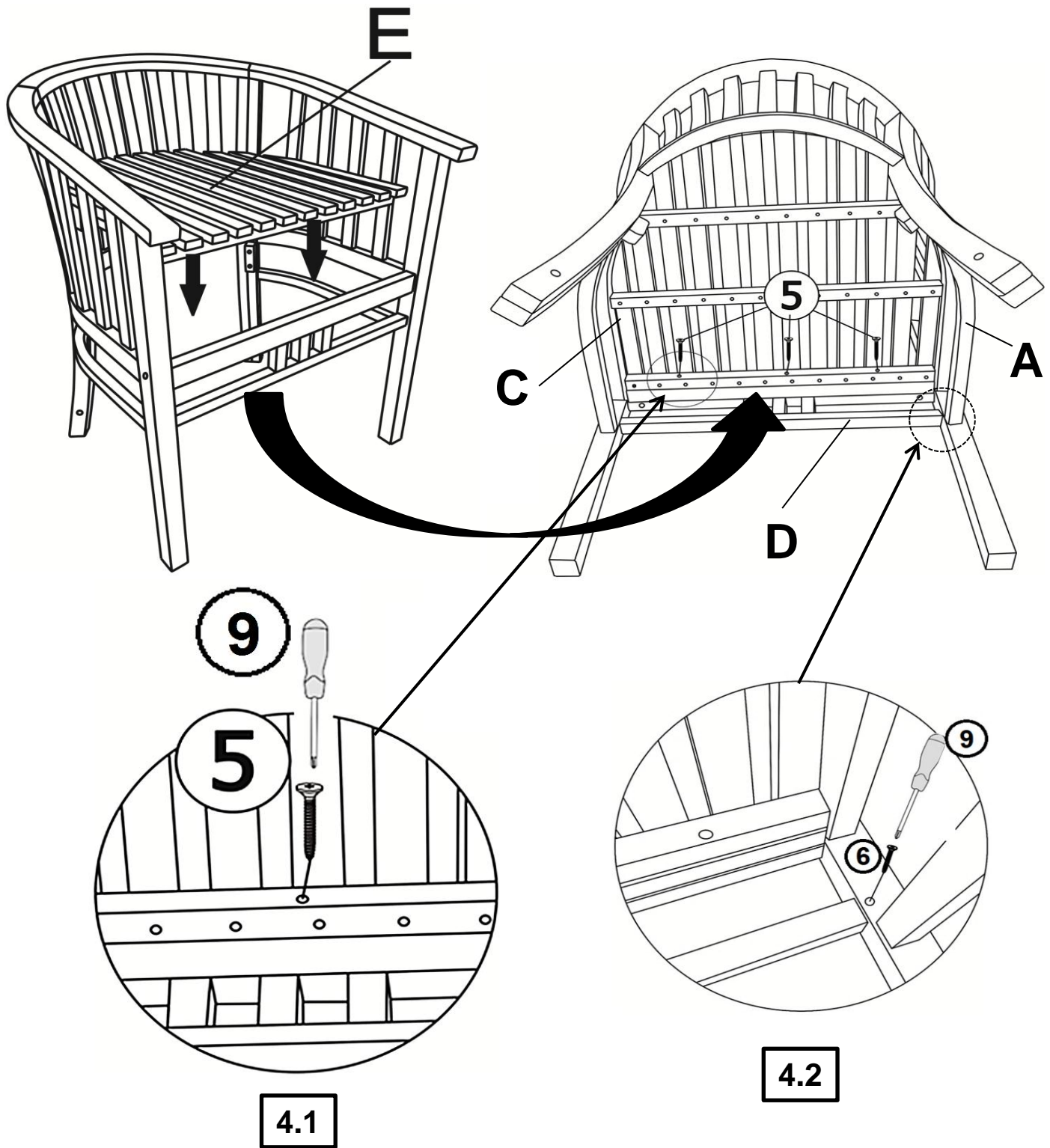

Place Seat Panel(E) onto the Chair as shown in picture above.

4.1) Turn the Chair facedown on a clean, non-marring surface, then attach Seat Panel(E) to Leg Support Bar(D) using Screws(5) with Screwdriver(9).

4.2) Attach Left Leg Panel(A) and Right Leg Panel(C) to Leg Support Bar(D) using Screws(6) with Screwdriver(9).

Do not fully tighten the Screws.

Step 5



Place the Chair on a LEVEL SURFACE.

Inspect the Chair and make sure all parts are adequately connected.

Carefully sit onto the Chair. This pressure will help align all parts at all joints.

In a sequential manner, tighten all Bolts and Screws at all joints.

When tightening the Bolts and Screws tighten sequentially.

DO NOT tighten any Bolt or Screw fully and then move on towards the next one.

If there are still wobbles, loosen the Bolts and Screws and execute this same process.

Step 6

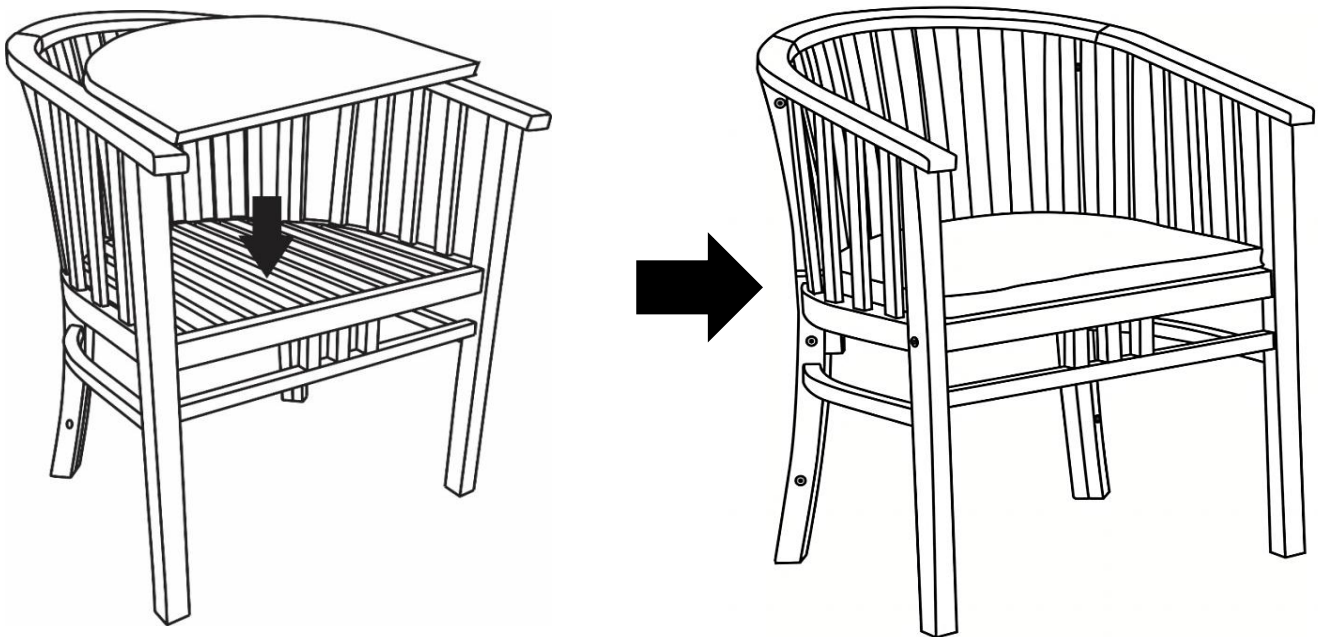









Place the Seat Cushion(F) into the chair.

Your Armchair is ready for use.

This Armchair can only be used on a flat, level surface.

Care & Maintenance

-  ● Do not put hot items directly on furniture surface
 -  ● Do not clean furniture with harsh cleansers or polish.
 -  ● To obtain the longest lifespan of your outdoor products, minimizing exposure to direct sunlight is recommended.
 -  ● Children should not climb or jump on the furniture.
 -  ● Do not write on furniture without a padded barrier to protect the surface.
 -  ● To obtain the longest lifespan of your outdoor products, avoid extended and lengthy exposure to rain, snow, and direct sunshine. Whenever possible cover the product and /or place under patio or awnings.
 -  ● Not for commercial use. For residential use only .
 -  ● Stains may be removed with mild soap solution and damp cloth.
-
-  ● Dust and pick-up spills using a clean, non-colored, lint-free cloth .