

# Assembly Instructions

## CM6156

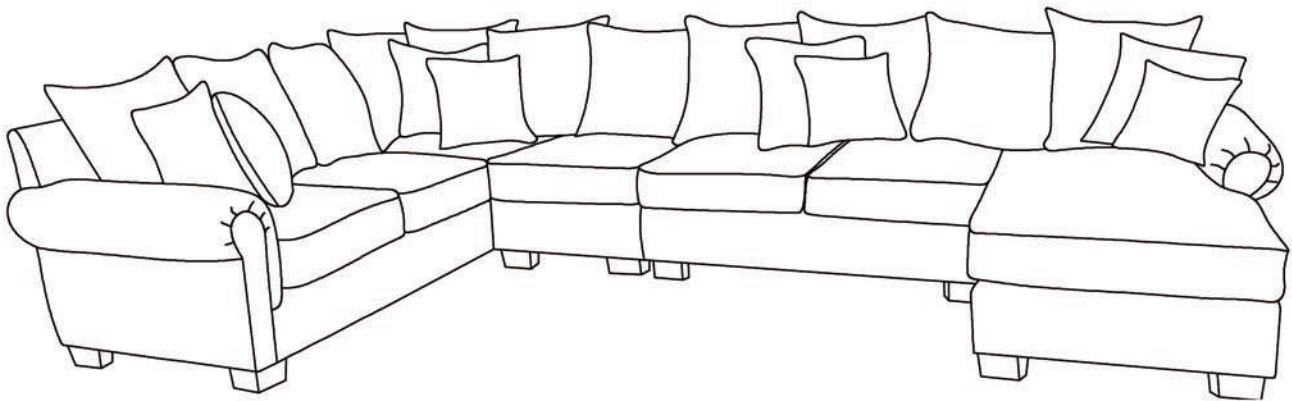

### ASSEMBLY RATING

The Assembly Rating is a 5-point system that shows the degree of effort needed in assembling a specific product (with 1 being easy and 5 being difficult). For some products, two persons are recommended.

EASY  DIFFICULT

### Tools Required for Assembly:

Allen Wrench

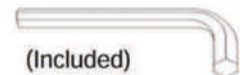

2 PERSONS RECOMMENDED

# ASSEMBLY & CARE ADVICE

FOR YOUR FURNITURE TO LAST, CORRECT ASSEMBLY AND PROPER MAINTENANCE ARE NECESSARY. PLEASE FOLLOW THE INFORMATION PROVIDED BELOW TO FULLY ENJOY YOUR FURNITURE.

## BASIC ASSEMBLY TECHNIQUES

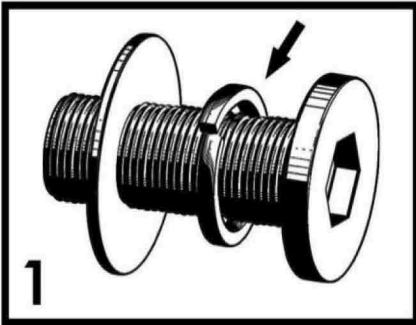

1  
When lock or spring washer is used in an assembly, please make sure the lock or spring washer is placed between the larger flat washer and the head of the screw or bolt.



2  
Position each part correctly and insert screws or bolts into their respective holes by hand tighten or using the proper hand tool. Only tighten when step is completed or when instructed to do so.

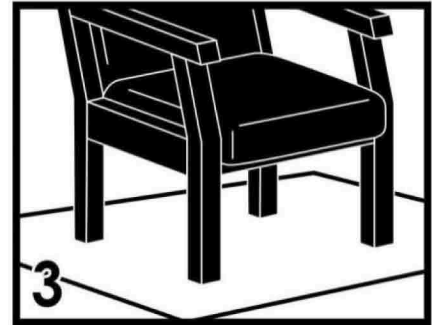

3  
Use cardboard or carpet area when assembling furniture to prevent scratches. Make sure the furniture rests on a flat and level surface with each leg evenly touching the floor.

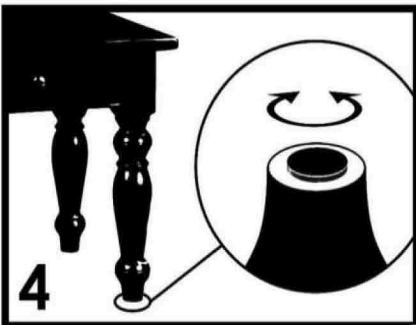

4  
Some furniture comes with height adjustment knobs underneath each leg. To lower or to raise each leg, you need to turn clockwise or counterclockwise, respectively.

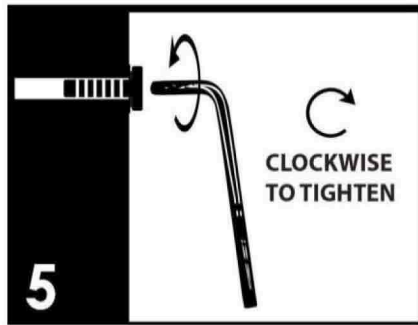

5  
Make sure all parts are properly aligned, then use the appropriate hand tool to completely tighten the bolts or screws. Do not use power tools and do not overtighten.

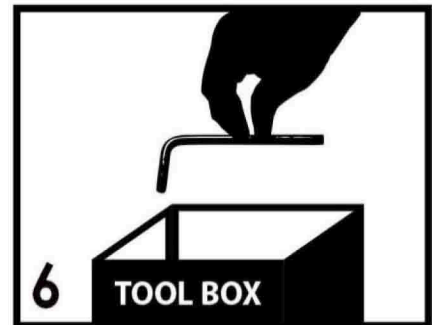

6  
Save the instructions and store the Allen wrench or any supplied tool for later maintenance. After two weeks, check and tighten any loose hardware and repeat again every six months thereafter.

IT IS THE USER'S RESPONSIBILITY TO MAINTAIN THE FURNITURE. THE HARDWARE MAY LOOSEN OVER TIME AND MAY CAUSE THE FURNITURE TO BE WOBBLY AND UNABLE TO SUPPORT ITS INTENDED WEIGHT CAPACITY. THIS MAY LEAD TO COLLAPSE AND MAY CAUSE SERIOUS INJURY.



FAILURE TO FOLLOW THE GUIDELINES ABOVE MAY RESULT IN INJURY AND/OR PROPERTY DAMAGE.

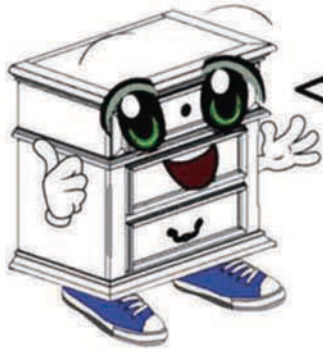

Before you begin, please read Page 2 of "Assembly and Care Advice".

And remember, do not tighten until each step is completed or instructed.

MD

### Parts List

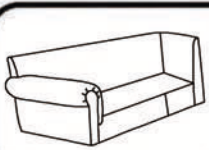

**#1X1PC  
SEAT**

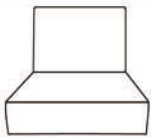

**#2X1PC  
SEAT**

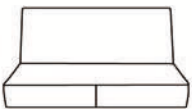

**#3X1PC  
SEAT**



**#4X1PC  
SEAT**

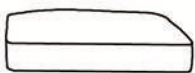

**#5X6PCS  
SEAT CUSHION**



**#6X1PC  
SEAT CUSHION**

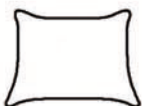

**#7X11PCS  
PILLOW**



**#8X4PCS  
PILLOW**



**#9X4PCS  
PILLOW**

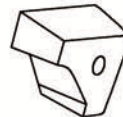

**#10X17PCS  
CASTER**



**#11X1PC  
MIDDLE LEG**

### Hardware List



**#AX1PC  
PLASTIC WASHER**



**#BX17PCS  
BOLT M8\*90mm**



**#CX17PCS  
FLAT WASHER M8\*24mm**



**#DX4PCS  
ALLREN WRENCH**

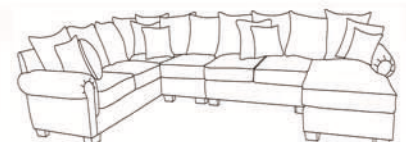



1. Insert the middle leg (#11) with a plastic washer (#A) into the center bottom hole of the seat (#1).

2. Align the casters (#10) to the holes along the bottom corners of the seat (#1), then insert a bolt (#B) with flat washer (#C) into the holes along each caster. Secure.

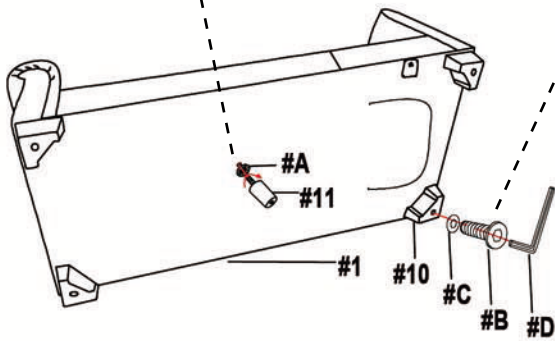

3. Place the seat cushions (#5) and pillows (#7).

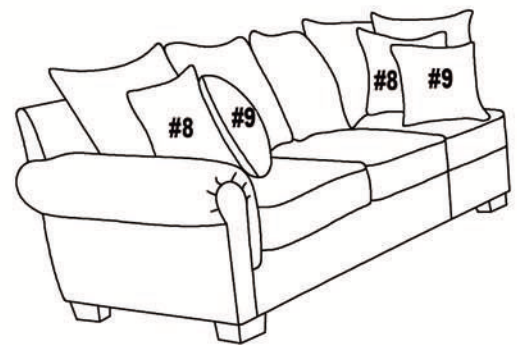
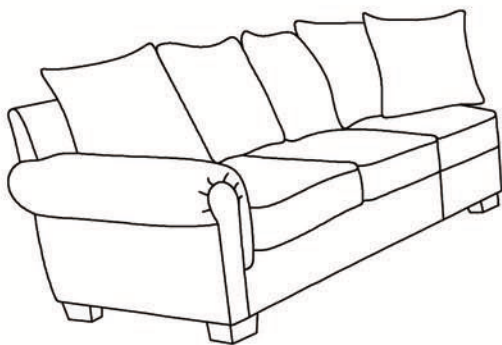
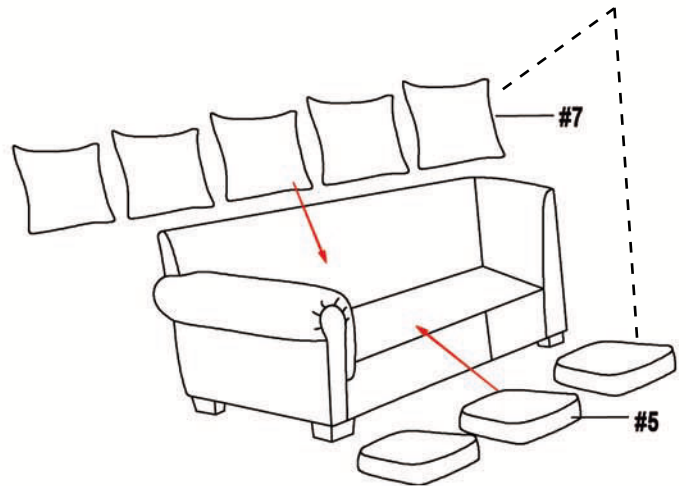



Align the casters (#10) to the holes along the bottom corners of the seat (#2), then insert a bolt (#B) with flat washer (#C) into the holes along each caster. Secure.

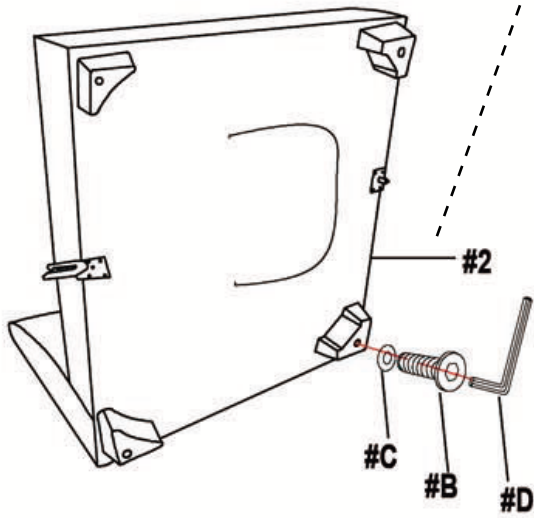

Place the seat cushions (#5) and pillows (#7).

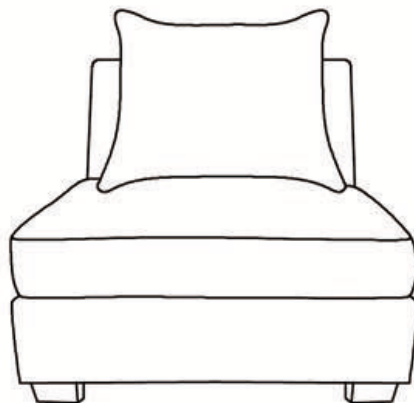
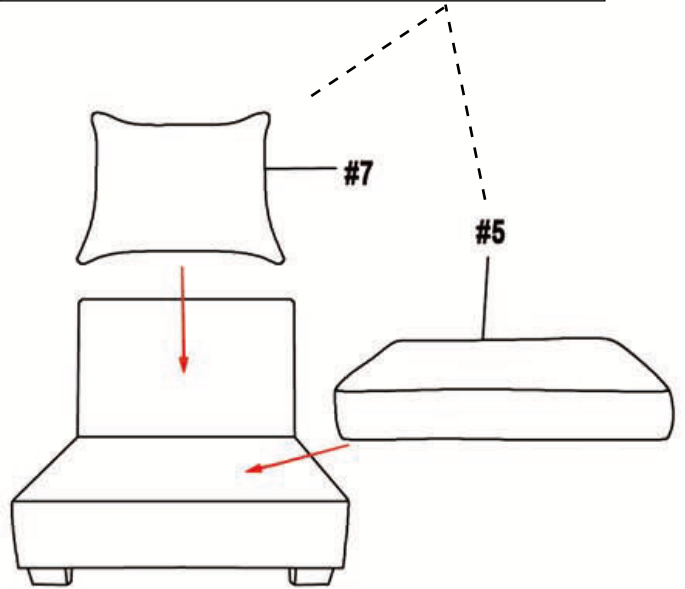



Align the casters (#10) to the holes along the bottom corners of the seat (#3), then insert a bolt (#B) with flat washer (#C) into the holes along each caster. Secure.

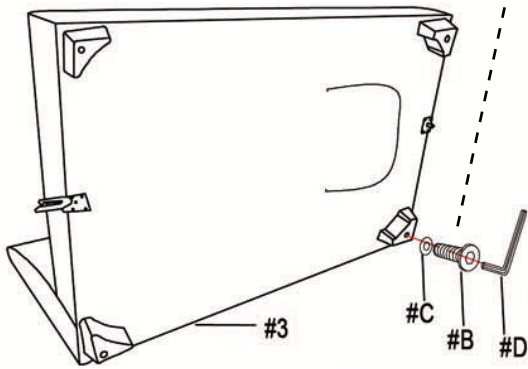

Place the seat cushions (#5) and pillows (#7).

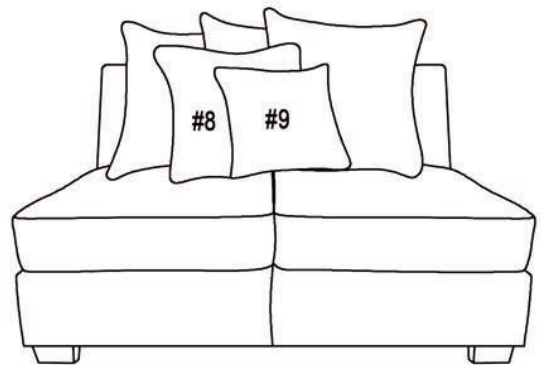
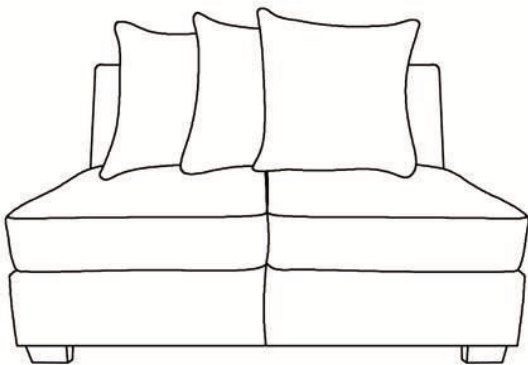
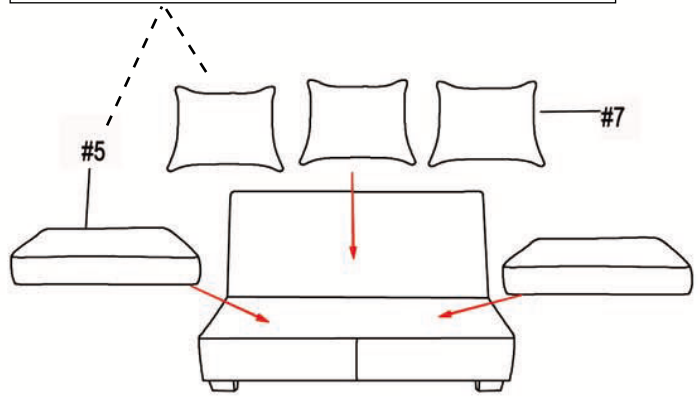



Align the casters (#10) to the holes along the bottom corners of the seat (#4), then insert a bolt (#B) with flat washer (#C) into the holes along each caster. Secure.

Place the seat cushions (#5) and pillows (#7).

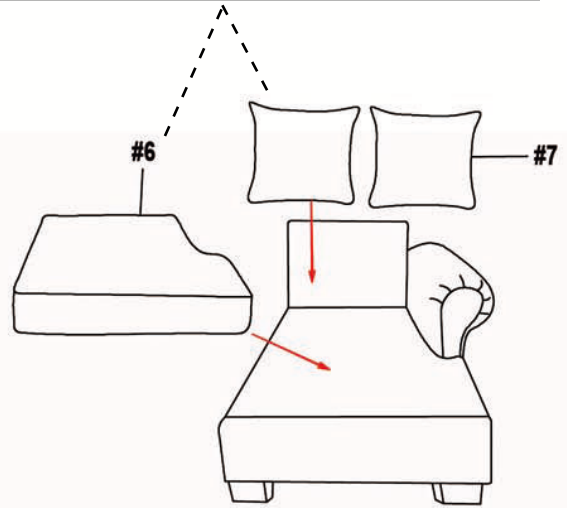
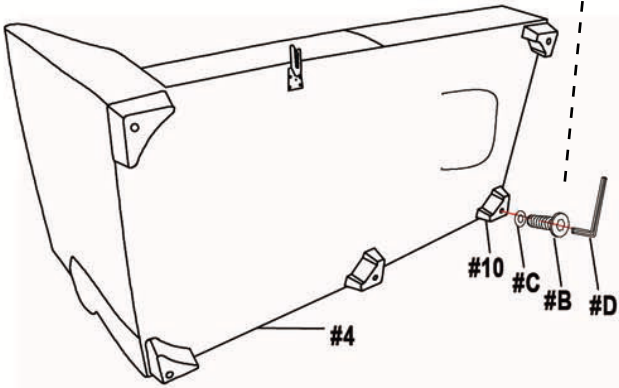



Align the brackets along the sides of the seats, then slide until fully secured.

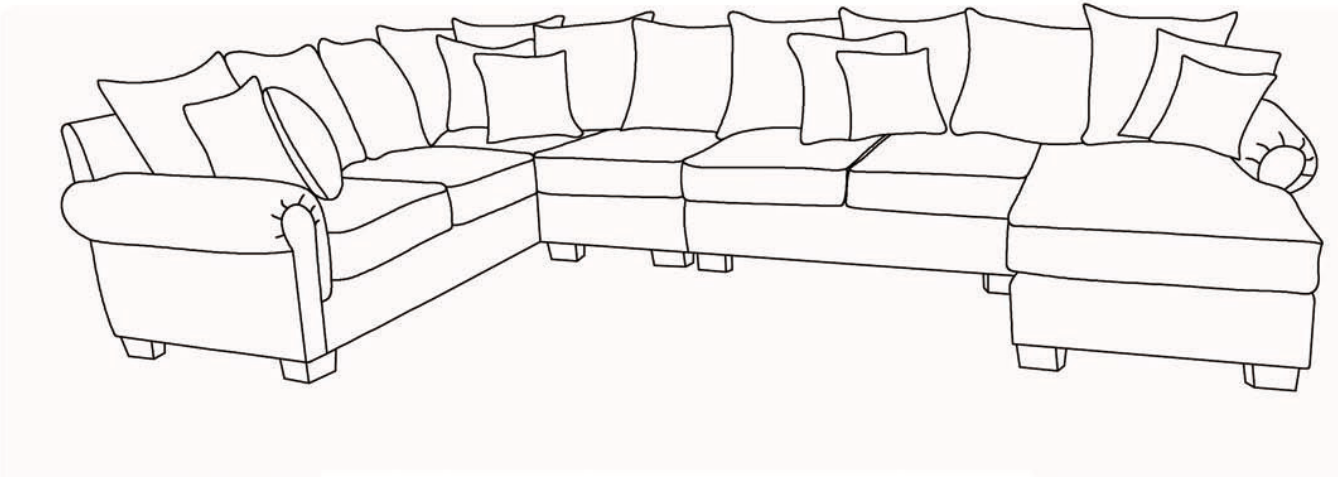
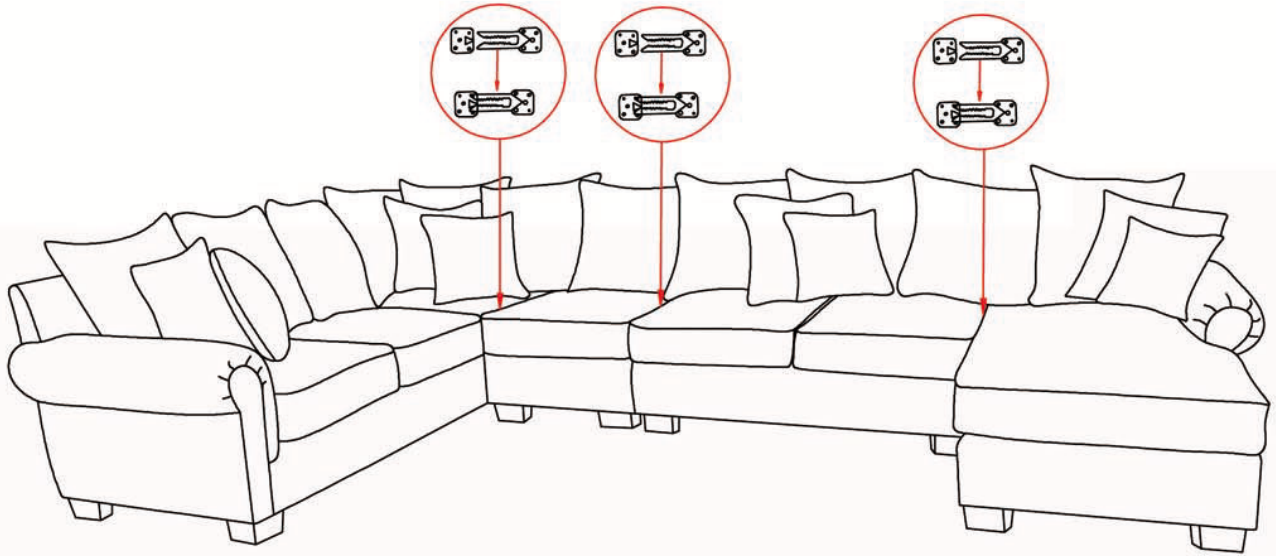

ASSEMBLY IS COMPLETED