

Laminate Modesty Panel

PP-LM60-B
Assembly Manual



Better Products for a Better Workspace Experience

We are dedicated to creating high-end ergonomic solutions
for the office with top of the industry support.

Explore Endless Workspace Solutions

www.vivo-us.com



WARNING



If you do not understand these directions, or if you have any doubts about the safety of the installation, please contact our product support team at 309-278-5303 or help@vivo-us.com for further assistance. Check carefully to make sure there are no missing or defective parts. Failure to report missing parts within 30 days may result in denial of free replacement. Improper installation may cause damage or serious injury. Do not use this product for any purpose that is not explicitly specified in this manual. Do not exceed weight capacity. We cannot be liable for damage or injury caused by improper mounting, incorrect assembly or inappropriate use.



WARNING: CHOKING HAZARD

SMALL PARTS - NOT FOR CHILDREN UNDER 3 YEARS. ADULT SUPERVISION IS REQUIRED.

Need Help? We're Here For You

US-Based Customer Support from Trained Professionals

Monday-Friday from 7am-7pm CST

Saturday 8am-4pm CST



Email Us

help@vivo-us.com



Chat with Live Agent

www.vivo-us.com



Give Us a Call

309-278-5303 ext. 1

Assembly Video & Product Info
www.vivo-us.com/products/pp-lm60-b



Package Contents

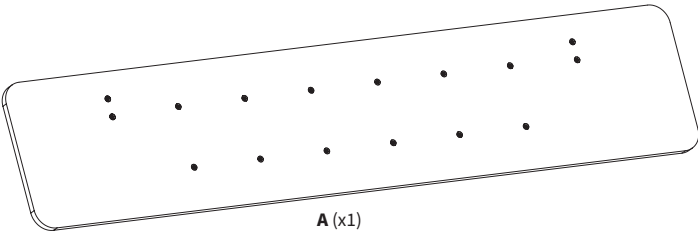

A (x1)
Panel

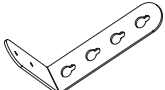

B (x2)
L Bracket



C (x12)
Strap Holder

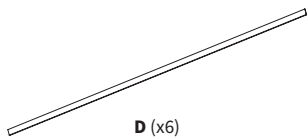

D (x6)
Strap

Included Hardware & Tools



S-A (x16)
M6x12mm
Screw



S-B (x4)
ST4.2x16mm
Screw

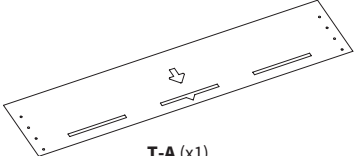

T-A (x1)
Template

Tools Needed:



**Phillips
Screwdriver**

Assembly Steps

STEP 1

Attach Strap Holders (C) to the center holes on Panel (A) using M6x12mm Screws (S-A) and a Phillips screwdriver.

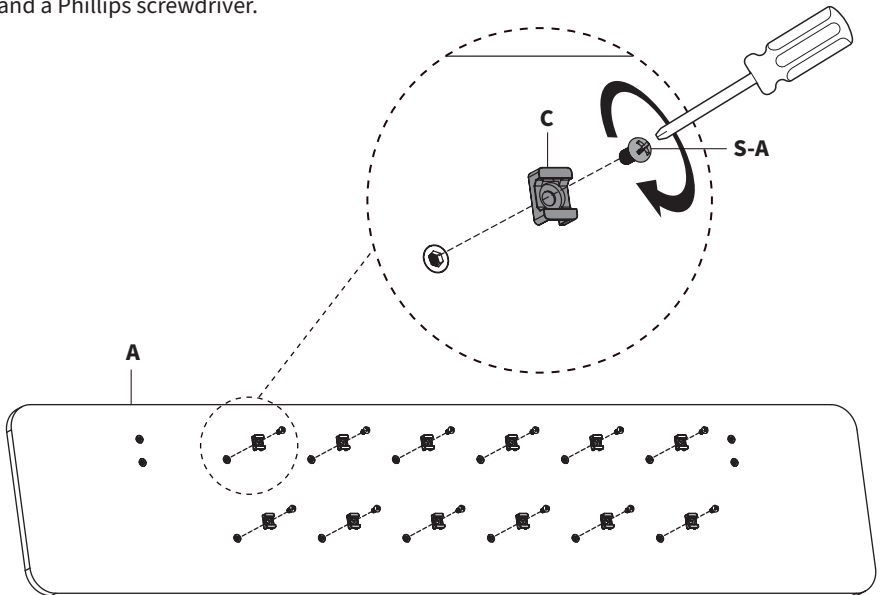

STEP 2

Feed Straps (D) through each pair of Strap Holders (C).

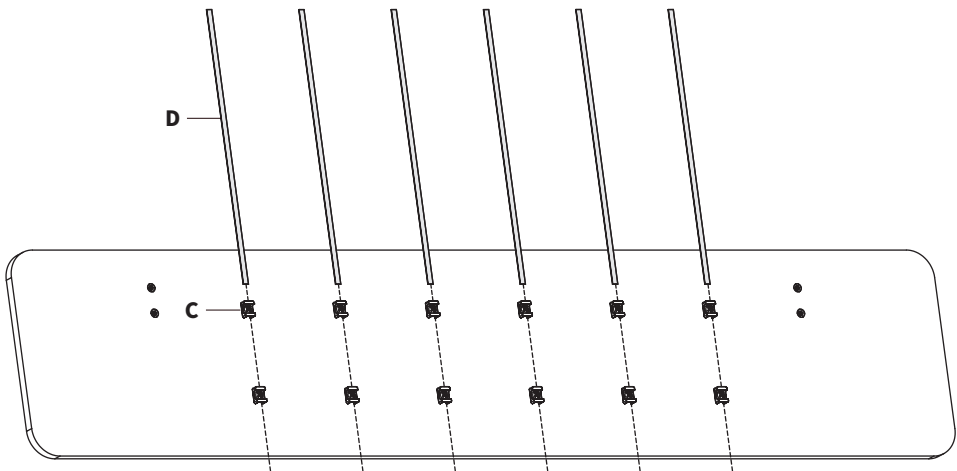

STEP 3

Use a Phillips screwdriver to thread four M6x12mm Screws (**S-A**) into the outside holes leaving 4mm of threading exposed.

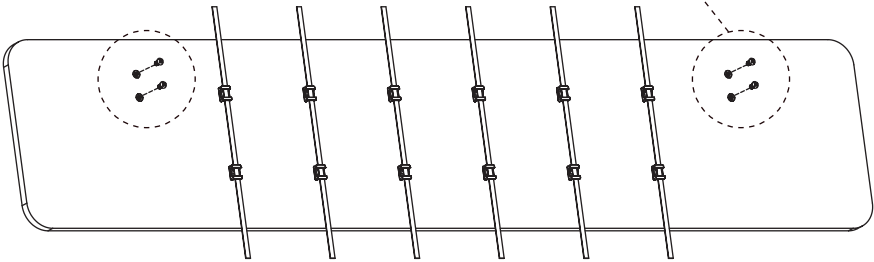
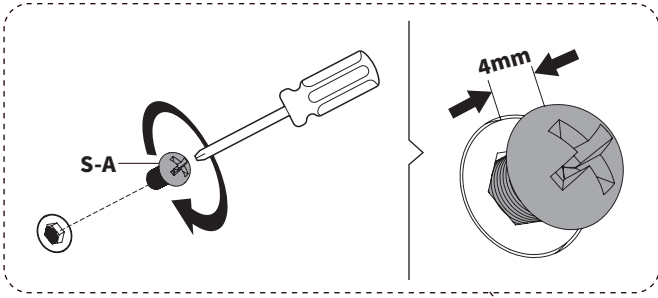

STEP 4

Align Template (**T-A**) on edge of underside of desktop ensuring the arrow is pointing towards the front edge. Use a pencil to mark the locations of any two adjacent holes, at the desired position.

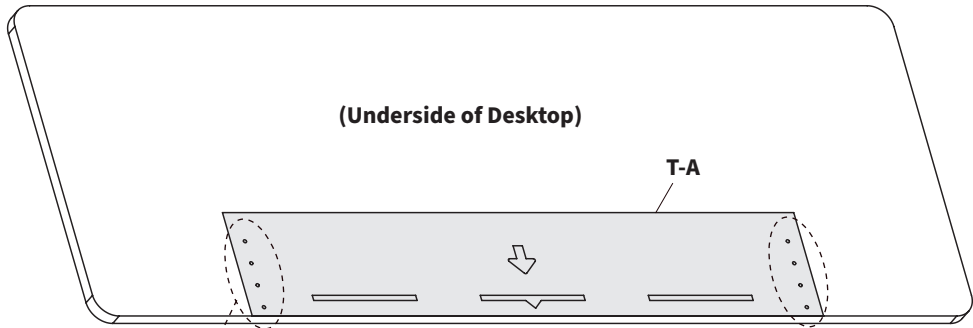

Choose the Option for Your Preferred Panel Position

Option 1 Protruded

Gap of 1.79" (45.5mm) between back of panel and edge of desk.

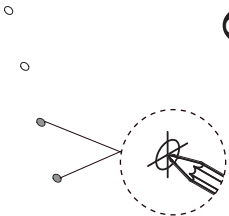

OR

Option 2 Flush-to-Edge

Panel has a 0.1" (3mm) gap from edge of the desk.

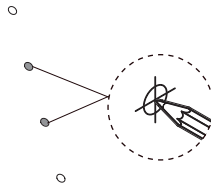

OR

Option 3 Inset*

Panel is 1.55" (39.5mm) back from the edge of the desk.

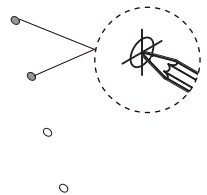

*If you choose **Option 3 - Inset**, you cannot mount the Panel at the highest position on the L Bracket (**B**).

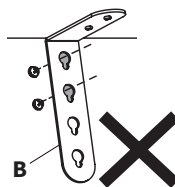
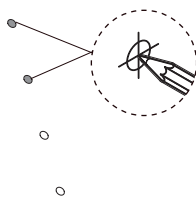

STEP 5

Drill mounting holes at marked locations using the infographic below.

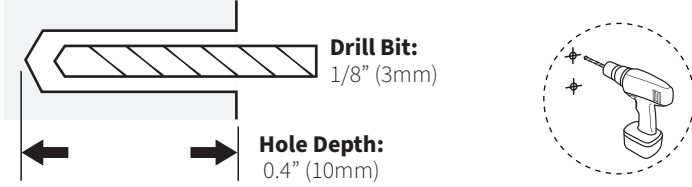

Attach the short side of L Brackets (**B**) to your desktop using ST4.2x16mm Screws (**S-B**) and a Phillips screwdriver.

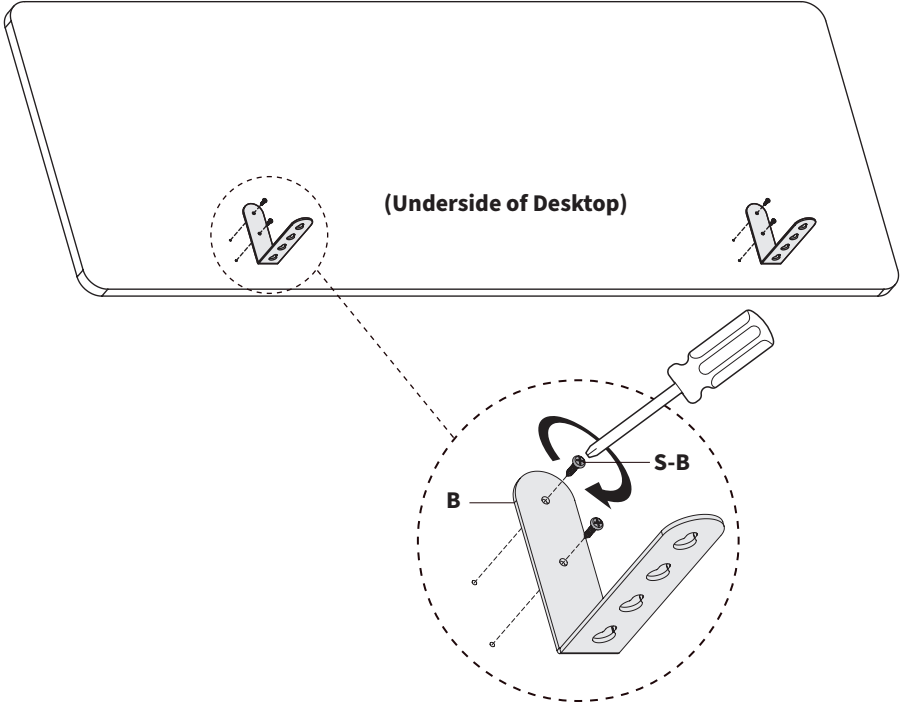

STEP 6

Hook the Panel (A) into the keyholes on L Brackets (B) at the desired height. Fully tighten the four previously installed M6x12mm Screws (S-A) using a Phillips screwdriver.

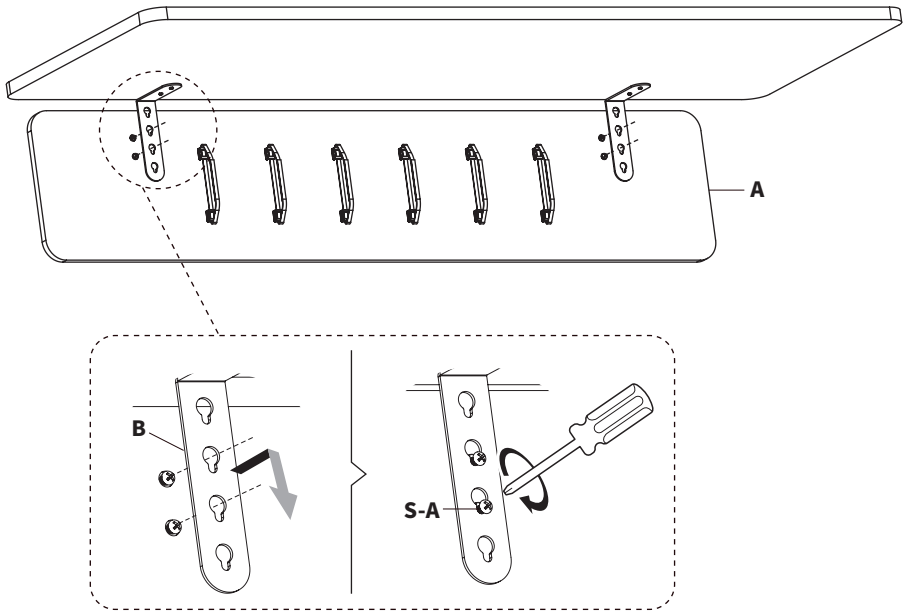

Choose the Option for Your Preferred Panel Height

Option 1

0.9"(23mm) Above the Bottom of Desktop

The *top* of the privacy panel is 0.9"(23mm) above the *bottom* of the desktop.

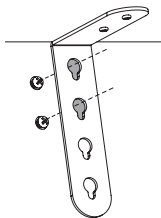

OR

Option 2

0.55"(14mm) Above the Bottom of Desktop

The *top* of the privacy panel is 0.55"(14mm) below the *bottom* of the desktop.

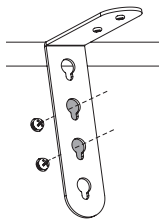

OR

Option 3

2.0"(51mm) Below the Bottom of Desktop

The *top* of the privacy panel is 2.0"(51mm) below the *bottom* of the desktop.

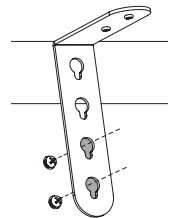

**This option is not available if you chose Option 3 on Step 4.*

STEP 7

Use Straps **(D)** to secure cords and accessories onto Panel **(A)**.

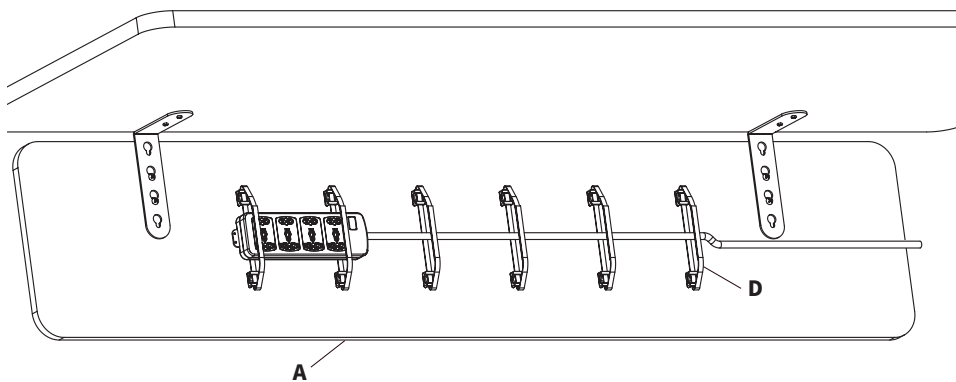

V·I·V·



Love Your New Setup?
Tag Us on Social!



@VIVO-us



@vivo_us



@VIVOus



VIVO



Need Help? **We're Here For You**

Monday-Friday from 7am-7pm CST

Saturday 8am-4pm CST



Email Us
help@vivo-us.com



Chat with Live Agent
www.vivo-us.com



Give Us a Call
309-278-5303 ext. 1



VIVO-us



@vivo_us



@VIVOus



VIVO