

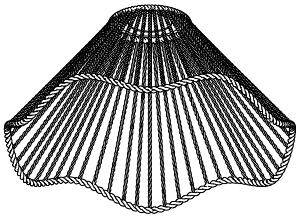







①	 lampshade 3pcs	② lock nut & teeth lock washer 3pcs ③ light arm 3pcs ④ universal joint 3pcs ⑤ socket ring 3pcs	⑥	 splicing connector 2pcs	 X 1PCS
			⑦	 electric wire 1pcs	 X 1PCS  X 3PCS  X 3PCS  X 3PCS  X 3PCS
⑧	canopy 1pcs	⑨	cap nut 2pcs		



Firstly use your hand to hold the bulbholder, loosen joint ④ to adjust the bulbholder to right direction, rotate to fasten the joint ④ at last.

1. Install the light arm ③ to the canopy ⑧ with lock nut & teeth lock washer ②, adjust the universal joint ④ to same direction like picture shown.
2. Adjust the direction of the bulb holder face to outside like picture shown by rotate universal joint ④. (please only rotate one round when adjust the universal joint ④)

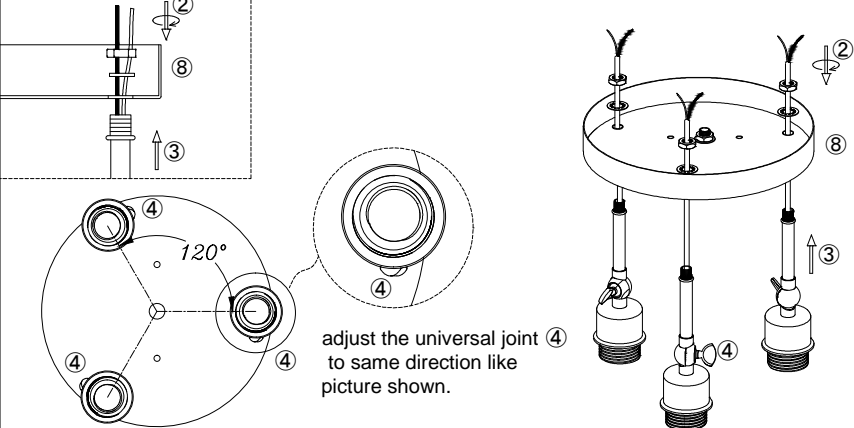
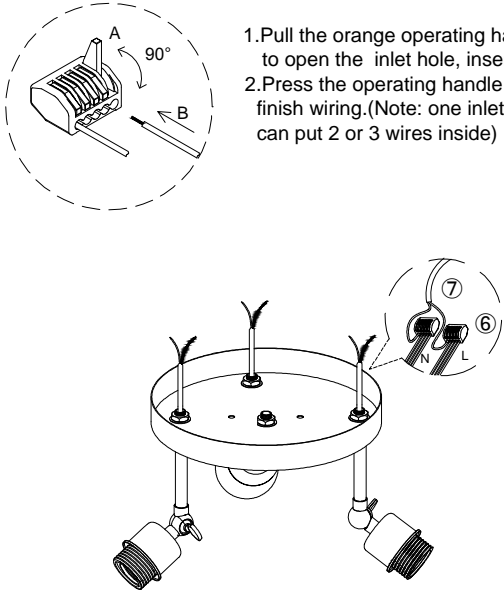

1. Pull the orange operating handle A to open the inlet hole, insert the wire B.
2. Press the operating handle A to finish wiring. (Note: one inlet hole can put 2 or 3 wires inside)

3. Connect all the wires and wire ⑦ together by parallel with connectors ⑥. (all live line-L use one connector, and neutral Line-N use another connector).

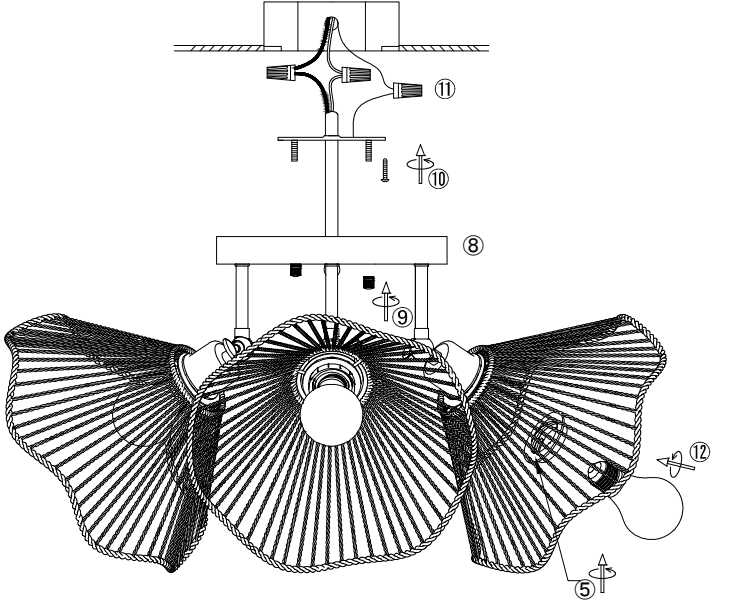

4. Install the bracket to the ceiling junction box with screw ⑩.
5. Connect the wire to your home line with cap connector ⑪.
6. Install the fixture to the bracket with cap nut ⑨.
7. Install the lampshade ① to the bulb holder with socket ring ⑤.
8. Install the bulb ⑫.

Please read carefully before installation!!!

Note : Please make sure that the electricity is powered off during installation !
Only a professional electrician should install this kind of product !