

**USER MANUAL**  

---

**Folding Shoe Box**

# Parts List

Please check if all parts are included as shown below.  
Should any parts miss, please feel free to contact us.



Folding Shoe Box	Shoe Box Frame	Shoe Box Plug	Shoe Box Bolt	Climp Strip	Shoe Box door
3 Layers	1	3	7	1	2+2
5 Layers	1	3	9	1	2+4
7 Layers	1	3	11	1	2+6
9 Layers	1	3	13	1	2+8
4 Layers	1	3	9	2	4+2
6 Layers	1	3	11	2	4+4
8 Layers	1	3	13	2	4+6

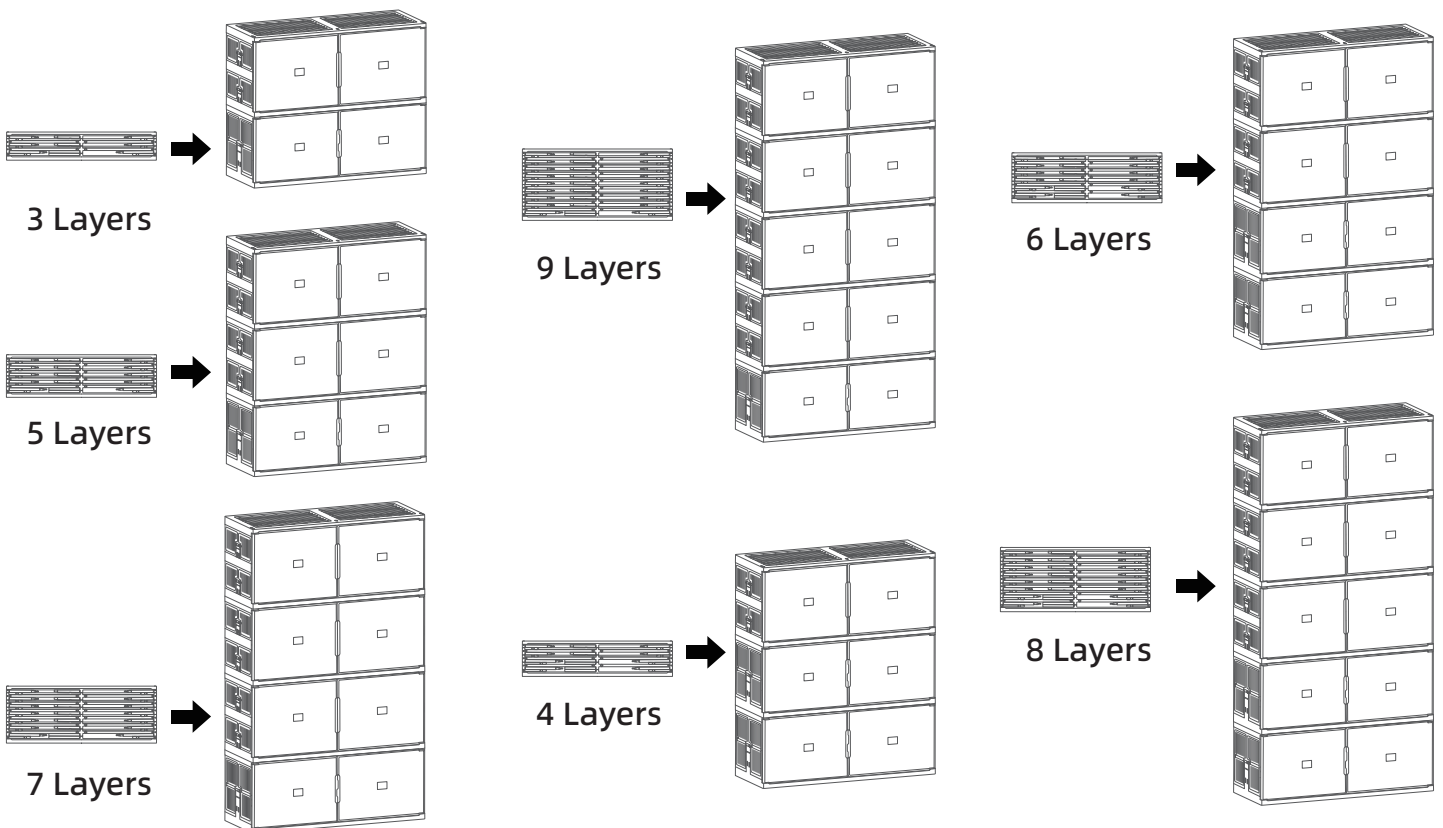

# Assembly Steps

**Step 1**

**Take out the shoe box, lay it down and stretch the frame of the shoe box.**

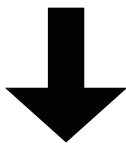
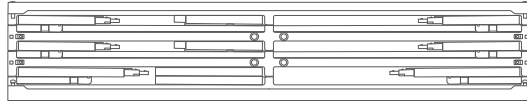

↑  
Stretch

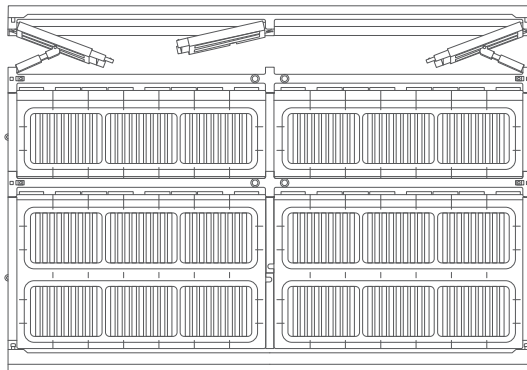

Lay it down

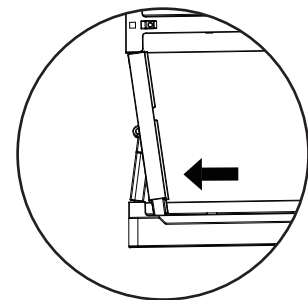
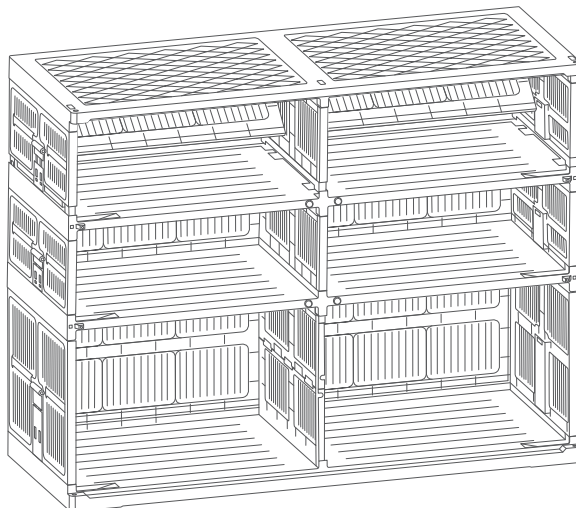

Press each side panels and snap them into slots.

# Assembly Steps

## Step 2

Set the shoe box upright, press the side panels down to make them snap into the frame grooves, rotate the rear boards and press them to make them mesh with the bottom boards.

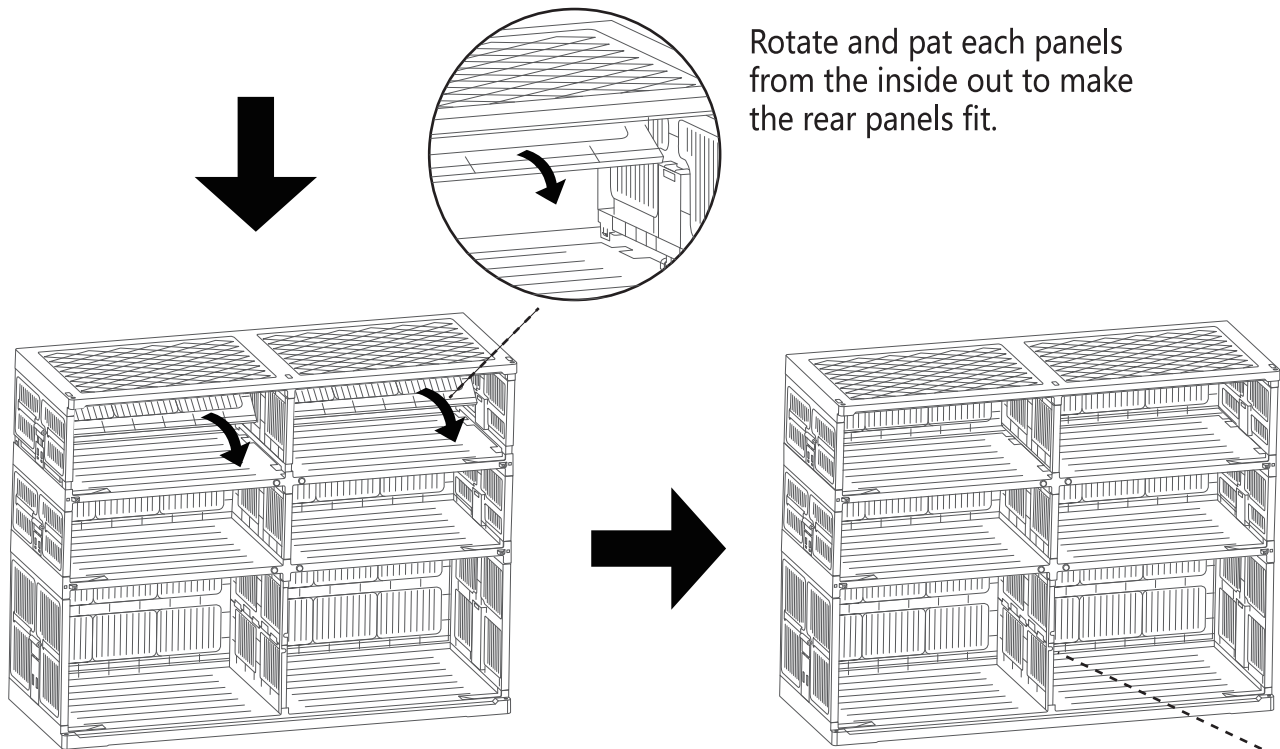
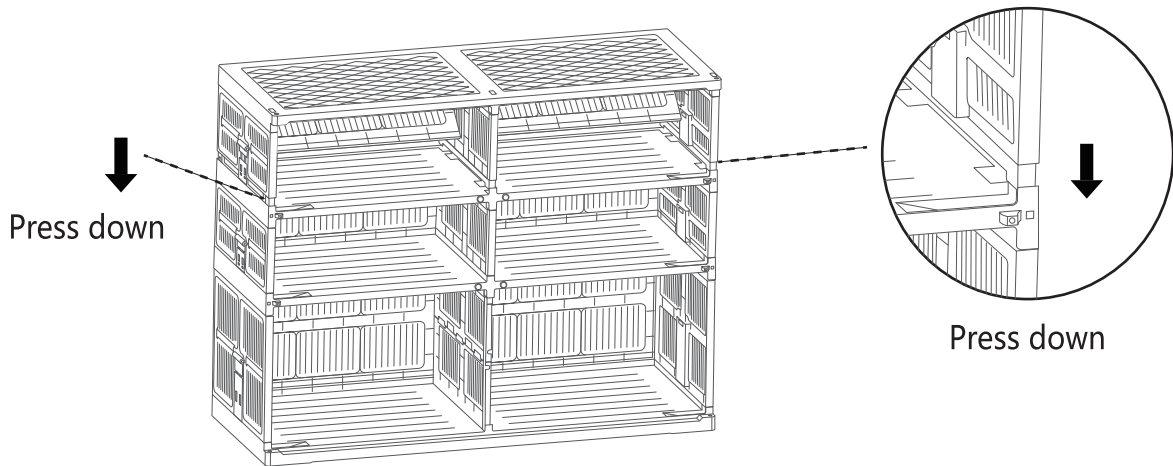

# Assembly Steps

## Step 3

Insert 3 plugs into the top holes to keep the shoe box from shaking.

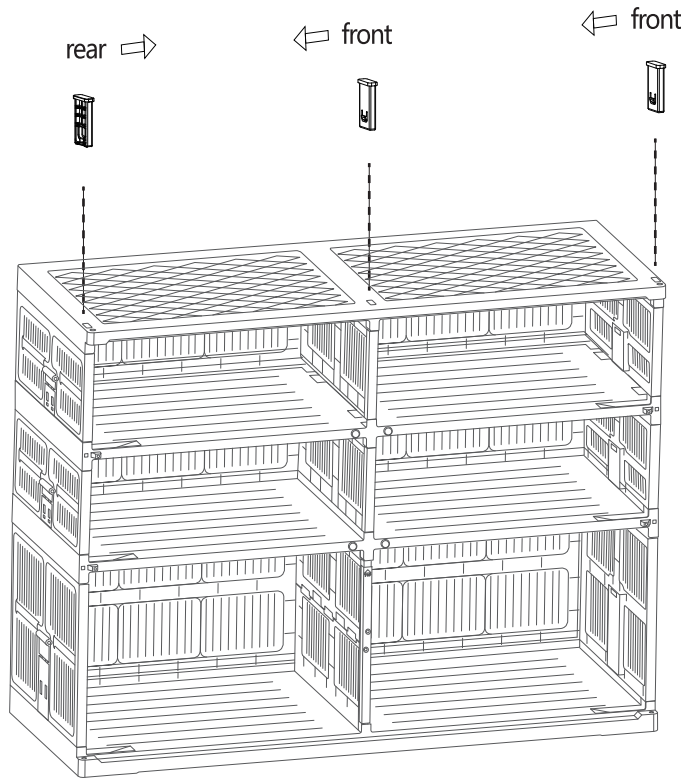

Shoe Box Plug

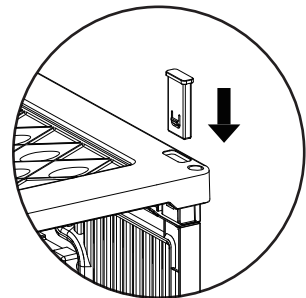

Insert 3 shoe box plugs

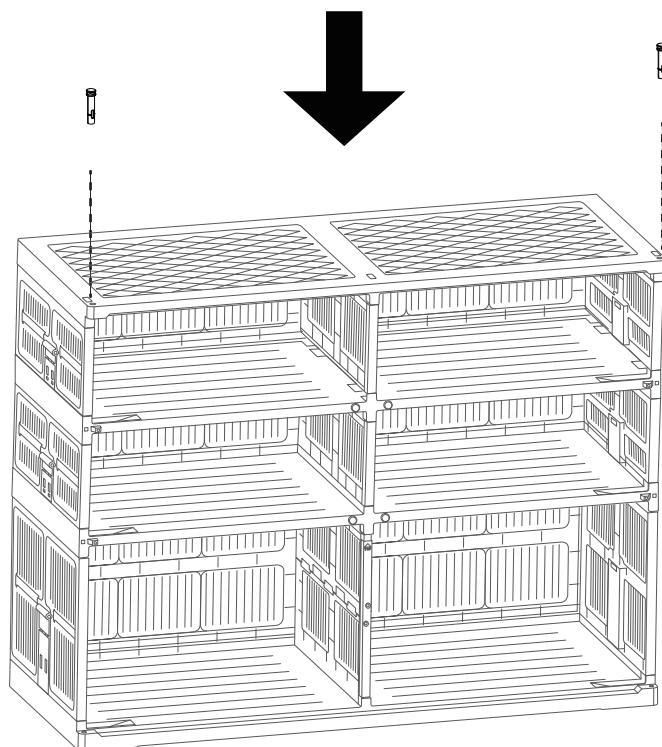

Shoe Box Bolt

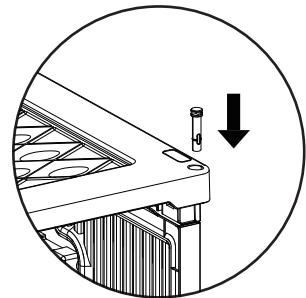

Insert the shoe box bolts

# Assembly Steps

## Step 4

Connect the door panels to the cabinet body, insert bolts to fix door panels.

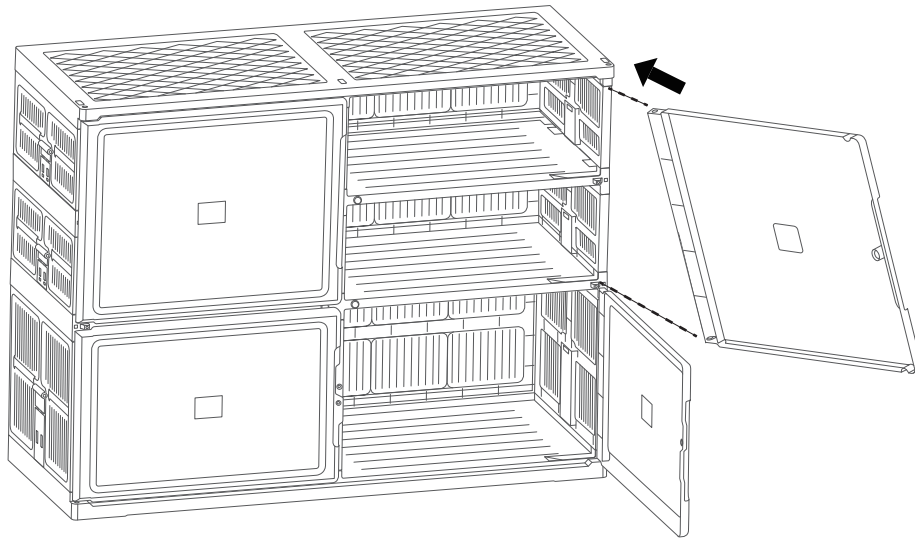

Tilt the door panels and make them fit into the bolts on the cabinet as shown.

**Note:** Slot into at a 45 angle

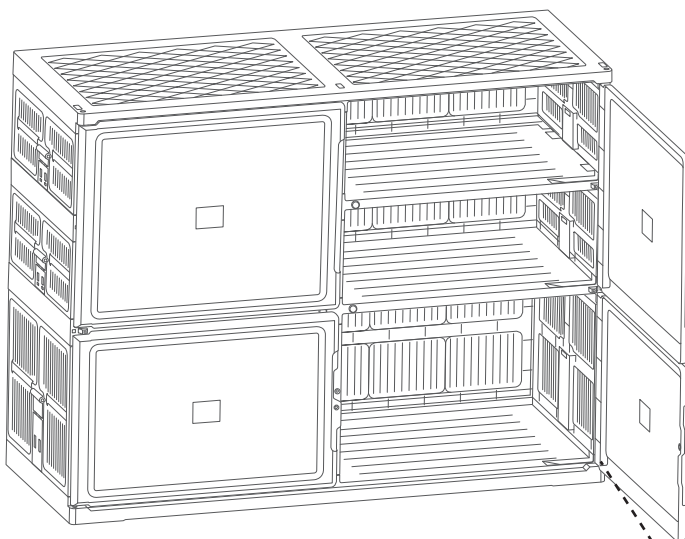
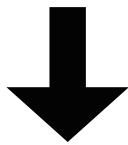

Insert the shoe box bolts

**Note:** Door panels are parallel to the cabinet body after installation, please align the door panels horizontally with the cabinet.