

ASSEMBLY INSTRUCTION

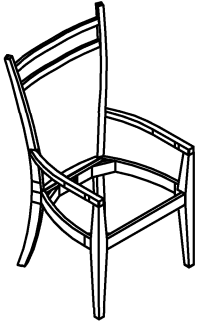

IMPORTANT NOTES :

- . Place all wooden parts on a clean and smooth surface such as a rug or carpet to prevent the parts from being scratched.
- . Check to be sure that you have all parts and hardware.
- . Remove all wrapping materials, including staples and packing straps before you start to assemble.
- . Do not tighten all screws and bolts until completely assembled.
- . Keep all hardware out of the reach of children.

Step4

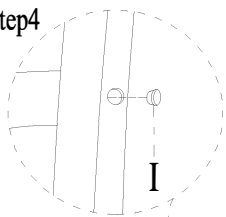

Step3

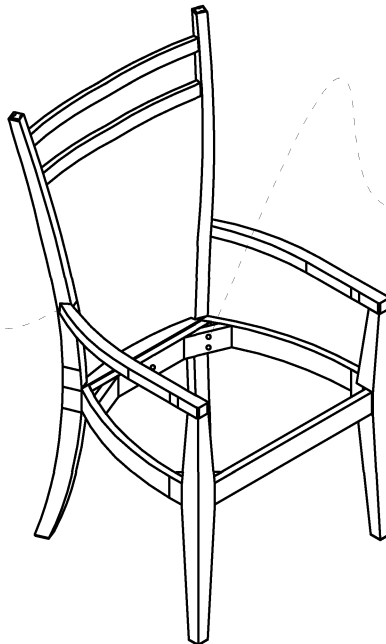
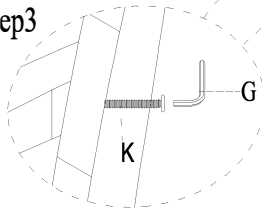

Step1

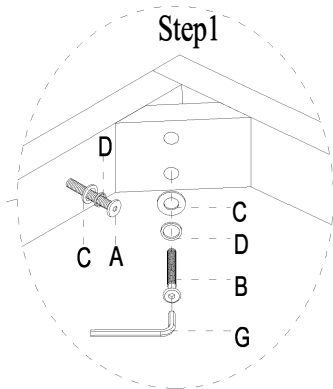

Step2

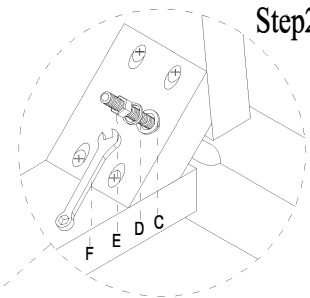

	Dimension	Shape	Quantity
A	Bolt 5/16"*38mm		1pcs
B	Bolt 5/16"*76mm		4pcs
C	Flat washer 5/16"*Ø19		9pcs
D	Lock washer 5/16"		9pcs
E	Nut 5/16"		4pcs
F	Wrench (12mm)		1pcs
G	Allen Key 4mm		1pcs
K	Bolt 1/4"*32mm		2pcs
I	Wood plug		2pcs

