

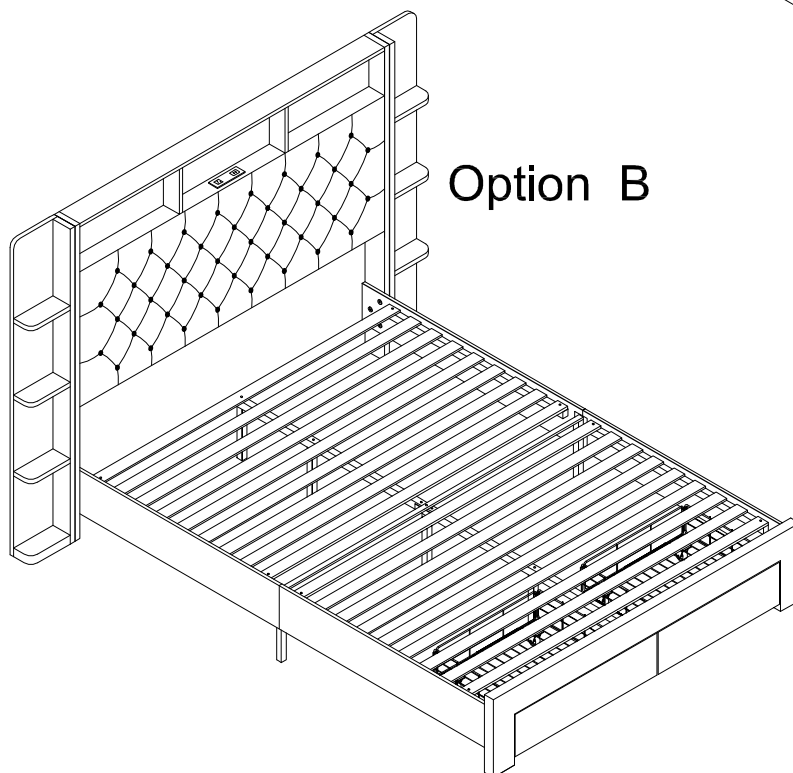

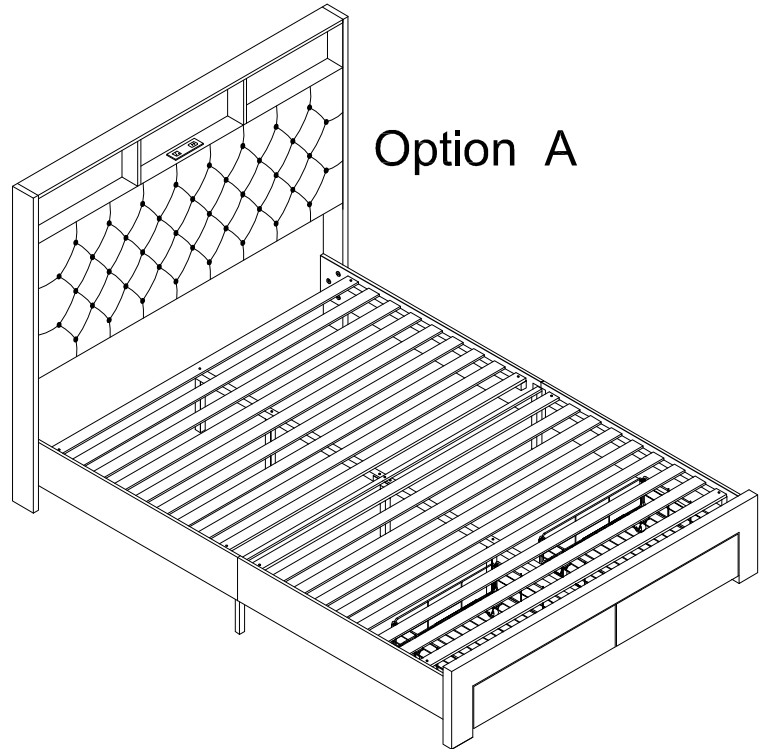



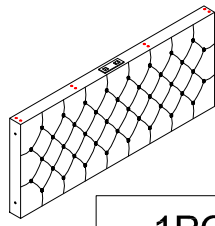
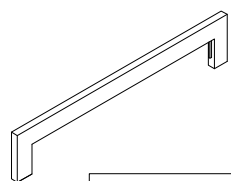
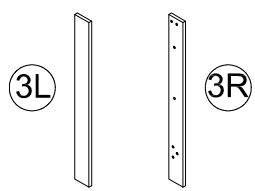
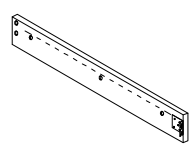
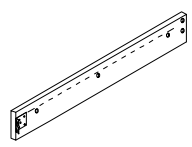
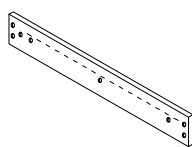
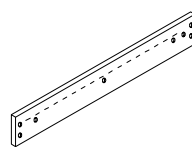
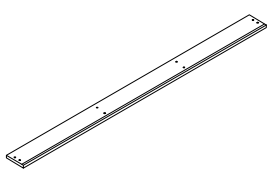
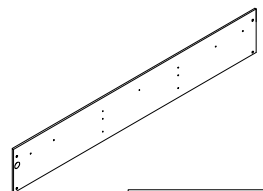
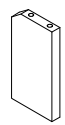
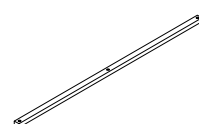

ASSEMBLY INSTRUCTION

500

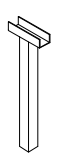

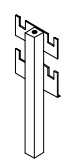
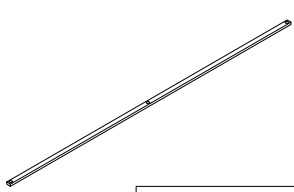
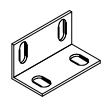

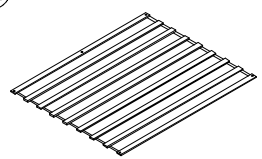

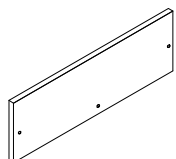
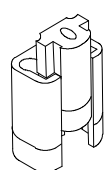
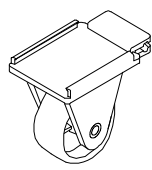
Upholstered Bed Frame
FULL/QUEEN SIZE



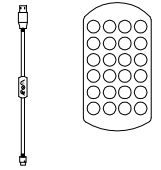
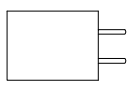
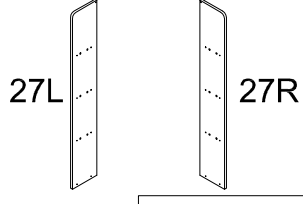

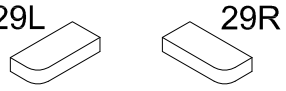
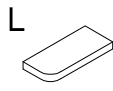

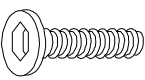
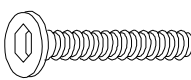
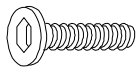

PARTS LIST

<p>① Headboard</p>  <p style="text-align: center;">1PC</p>	<p>② Footboard</p>  <p style="text-align: center;">1PC</p>	<p>③ HB Leg</p>  <p style="text-align: center;">2PCS</p>	<p>④ Side Rail (R)</p>  <p style="text-align: center;">1PC</p>
<p>⑤ Side Rail (L)</p>  <p style="text-align: center;">1PC</p>	<p>⑥ Side Rail (R)</p>  <p style="text-align: center;">1PC</p>	<p>⑦ Side Rail (L)</p>  <p style="text-align: center;">1PC</p>	<p>⑧ HB Upper Deck</p>  <p style="text-align: center;">1PC</p>
<p>⑨ HB Back panel</p>  <p style="text-align: center;">1PC</p>	<p>⑩ HB panel</p>  <p style="text-align: center;">2PCS</p>	<p>⑪ Side rail support</p>  <p style="text-align: center;">4PCS</p>	<p>⑫ Center support rail</p>  <p style="text-align: center;">1PC</p>
<p>⑬ Center support rail</p>  <p style="text-align: center;">1PC</p>	<p>⑭ Center Support Leg</p>  <p style="text-align: center;">1PC</p>	<p>⑮ Support Leg</p>  <p style="text-align: center;">3PCS</p>	<p>⑯ Side rail feet</p>  <p style="text-align: center;">2PCS</p>
<p>⑰ Center cross bar</p>  <p style="text-align: center;">1PC</p>	<p>⑱ ANGLE IRON</p>  <p style="text-align: center;">2PCS</p>	<p>⑲ LED light belt</p>  <p style="text-align: center;">1PC</p>	<p>⑳ Slats</p>  <p style="text-align: center;">2SET</p>
<p>㉑ FB Drawer</p>  <p style="text-align: center;">2PCS</p>	<p>㉒ FB Drawer panel</p>  <p style="text-align: center;">2PCS</p>	<p>㉓ Drawer connector</p>  <p style="text-align: center;">4PCS</p>	<p>㉔ Drawer wheel</p>  <p style="text-align: center;">8PCS</p>

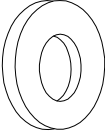
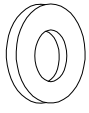
PARTS LIST

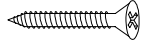
<p>25 Remote Control</p>  <div style="border: 1px solid black; width: 50px; margin: 5px auto; text-align: center;">1PC</div>	<p>26 Power</p>  <div style="border: 1px solid black; width: 50px; margin: 5px auto; text-align: center;">1PC</div>	<p>27</p>  <div style="border: 1px solid black; width: 50px; margin: 5px auto; text-align: center;">2PCS</div>	<p>28</p>  <div style="border: 1px solid black; width: 50px; margin: 5px auto; text-align: center;">2PCS</div>
<p>29</p>  <div style="border: 1px solid black; width: 50px; margin: 5px auto; text-align: center;">2PCS</div>	<p>30</p>  <div style="border: 1px solid black; width: 50px; margin: 5px auto; text-align: center;">3PCS</div>	<p>31</p>  <div style="border: 1px solid black; width: 50px; margin: 5px auto; text-align: center;">3PCS</div>	<p>32 FB Leg</p>  <div style="border: 1px solid black; width: 50px; margin: 5px auto; text-align: center;">1PC</div>

HARDWARE LIST

<p>A Screw</p>  <div style="border: 1px solid black; width: 50px; margin: 5px auto; text-align: center;">5/16"*35mm 22+2PCS</div>	<p>B Screw</p>  <div style="border: 1px solid black; width: 50px; margin: 5px auto; text-align: center;">5/16"*50mm 2PCS</div>	<p>C Screw</p>  <div style="border: 1px solid black; width: 50px; margin: 5px auto; text-align: center;">1/4"*38mm 12+1PCS</div>	<p>D Screw</p>  <div style="border: 1px solid black; width: 50px; margin: 5px auto; text-align: center;">1/4"*15mm 22+2PCS</div>
<p>E Lock Washer</p>  <div style="border: 1px solid black; width: 50px; margin: 5px auto; text-align: center;">5/16"*13mm 24+2PCS</div>	<p>F Flat Washer</p>  <div style="border: 1px solid black; width: 50px; margin: 5px auto; text-align: center;">5/16"*19mm 24+2PCS</div>	<p>G Flat Washer</p>  <div style="border: 1px solid black; width: 50px; margin: 5px auto; text-align: center;">1/4"*16mm 34+2PCS</div>	<p>H Screw</p>  <div style="border: 1px solid black; width: 50px; margin: 5px auto; text-align: center;">M4*35mm 58+3PCS</div>
<p>I Screw</p>  <div style="border: 1px solid black; width: 50px; margin: 5px auto; text-align: center;">M4*35mm 6+1PCS</div>	<p>J Wooden tenons</p>  <div style="border: 1px solid black; width: 50px; margin: 5px auto; text-align: center;">30*8mm 26+1PCS</div>	<p>K Inner allen wrench</p>  <div style="border: 1px solid black; width: 50px; margin: 5px auto; text-align: center;">5/16"*100mm 1PC</div>	<p>L Inner allen wrench</p>  <div style="border: 1px solid black; width: 50px; margin: 5px auto; text-align: center;">1/4"*65mm 1PC</div>

Assembly Steps

STEP 1:

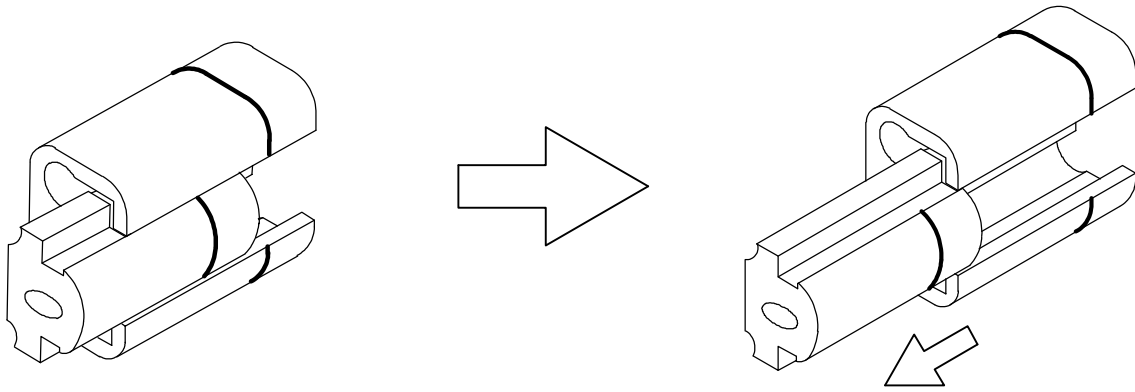

You can pull the buckle out by following the direction indicated by the arrow

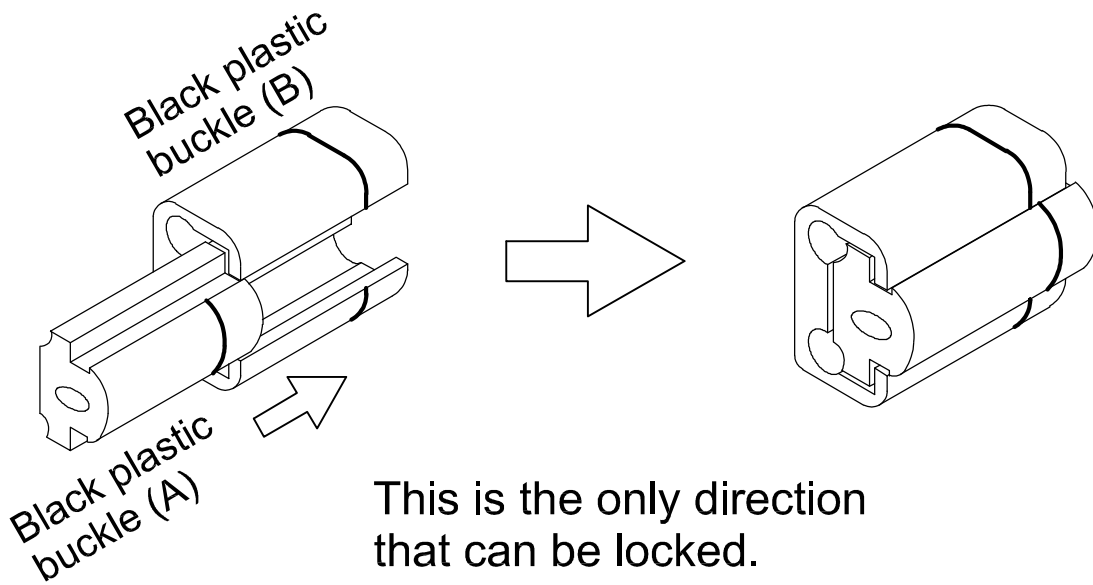

This is the only direction that can be locked.

STEP 2:

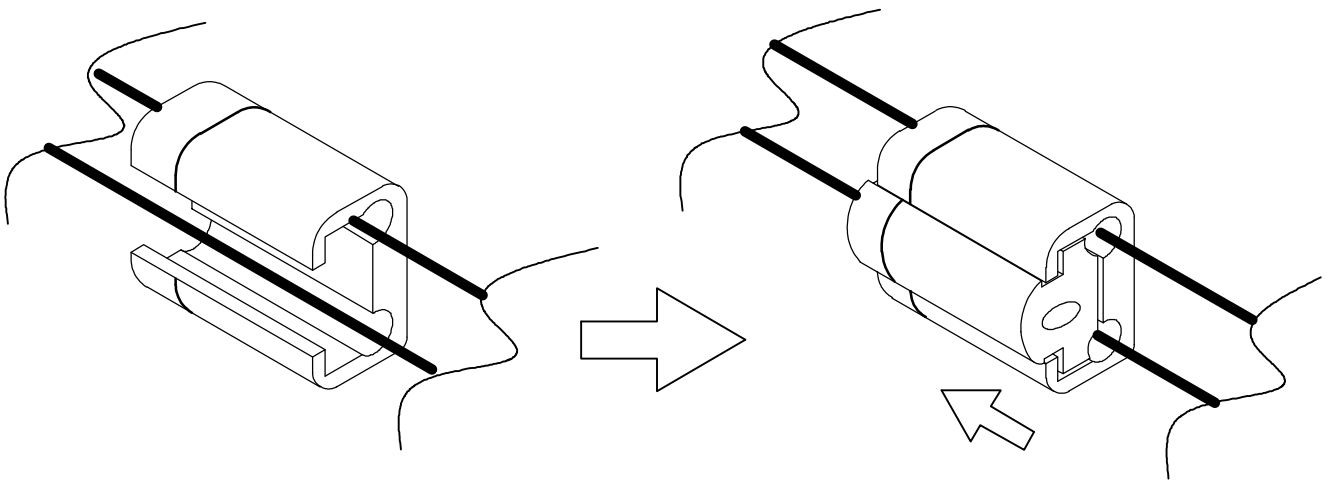

Place round iron tube as shown for better drawer assembly

Assembly Steps

STEP 3:

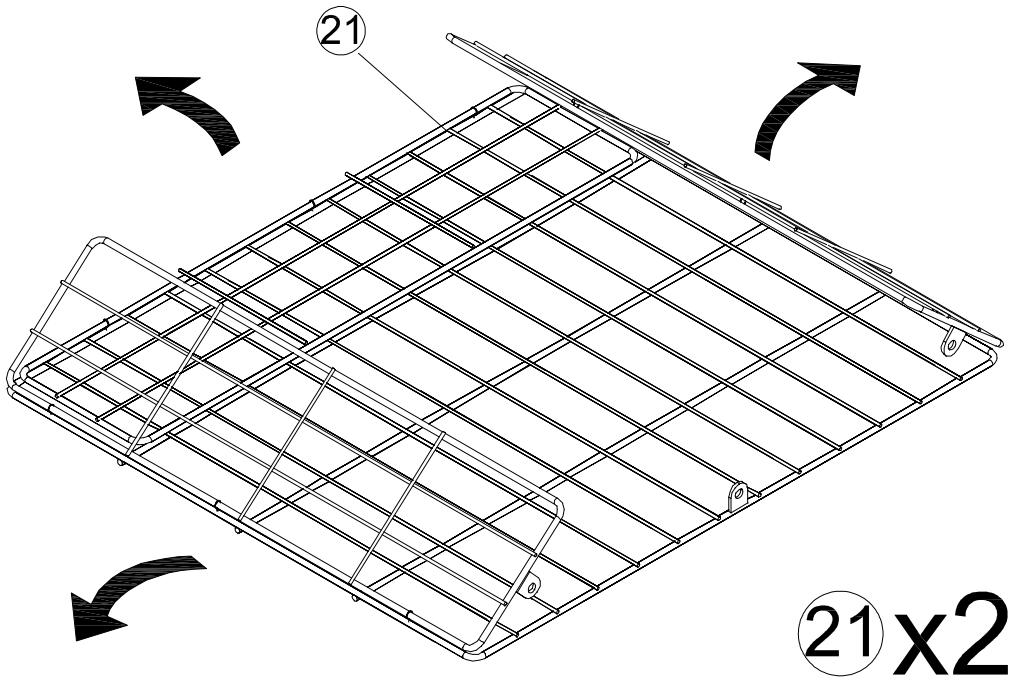

STEP 4:

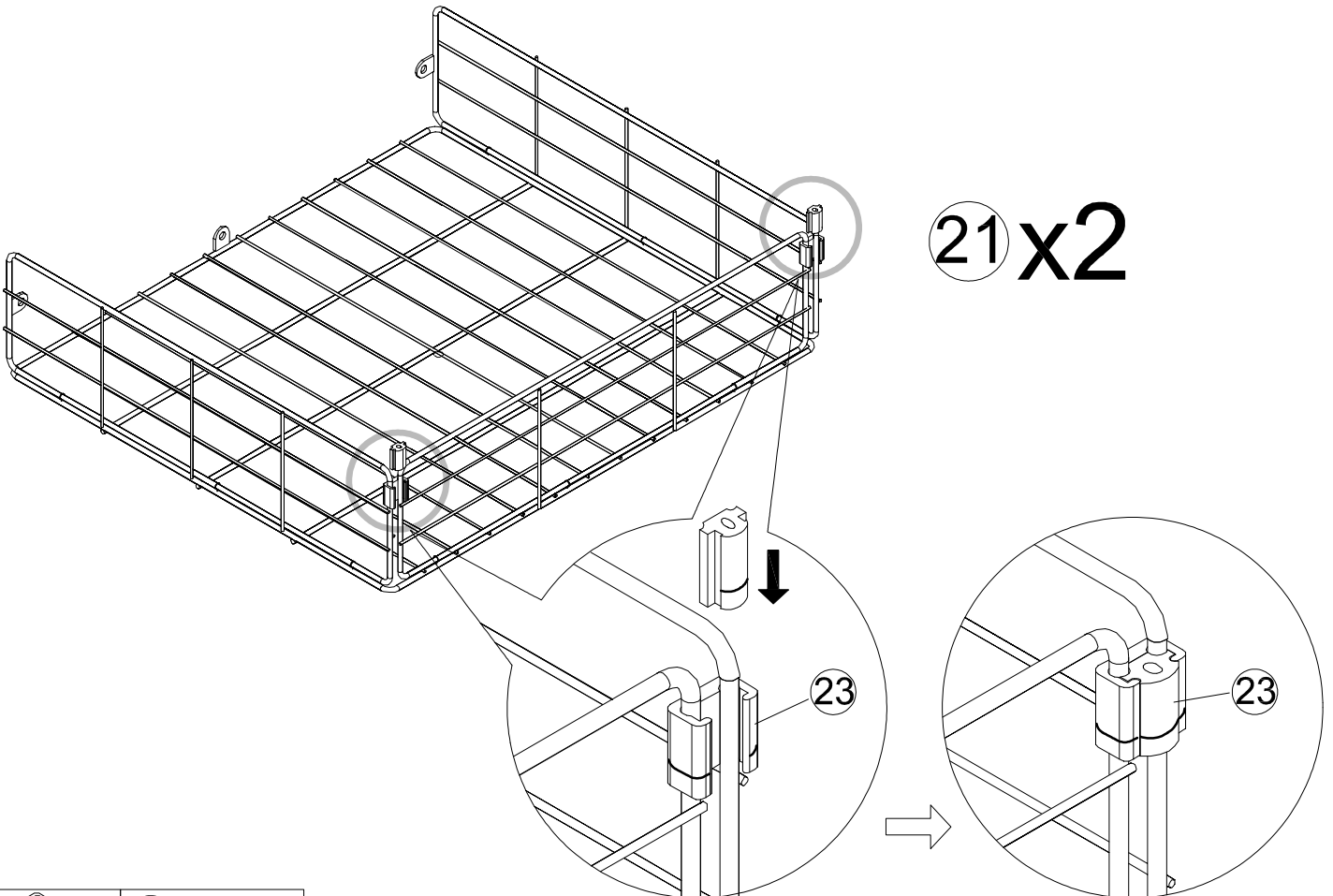

Assembly Steps

STEP 5:

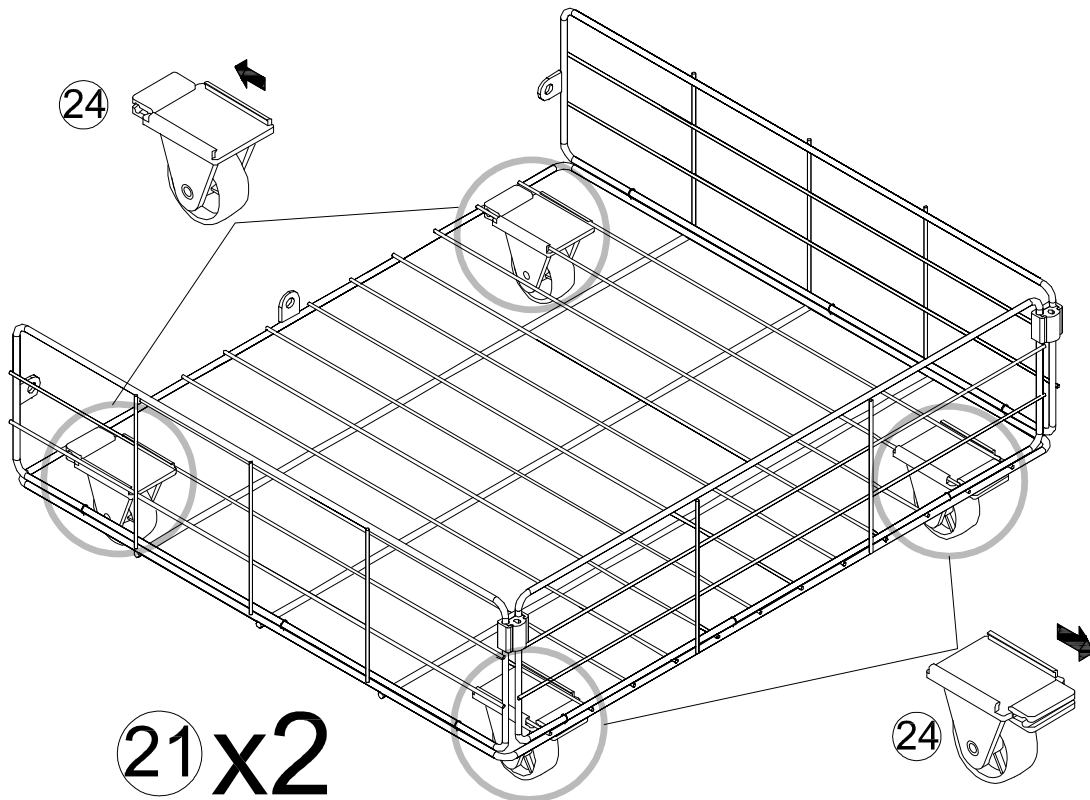
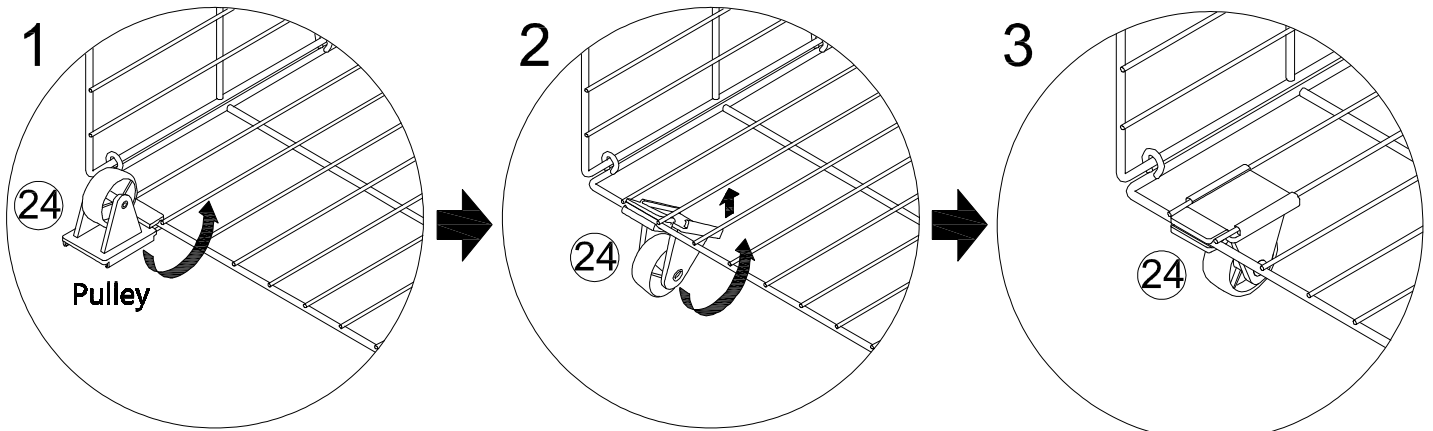

Place the round iron tubes as shown for better assembly of the drawers.





24 x 8PCS

Assembly Steps

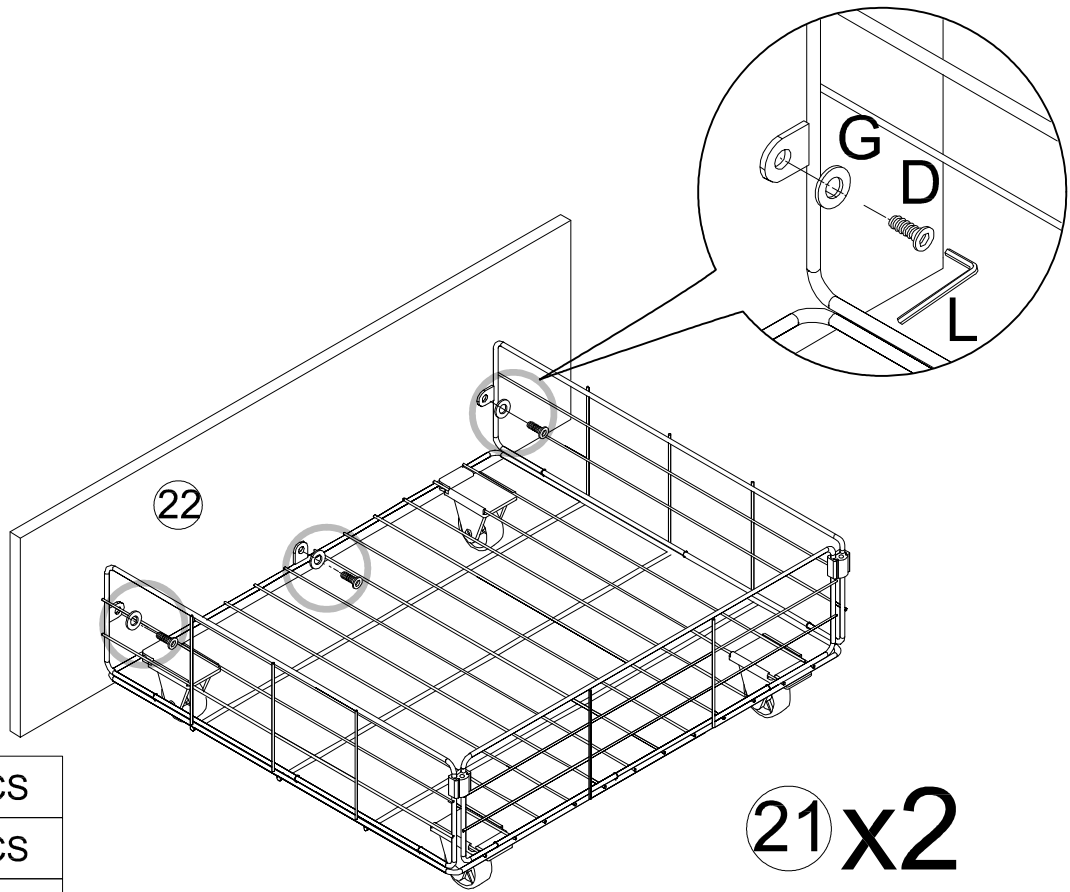
STEP 6:





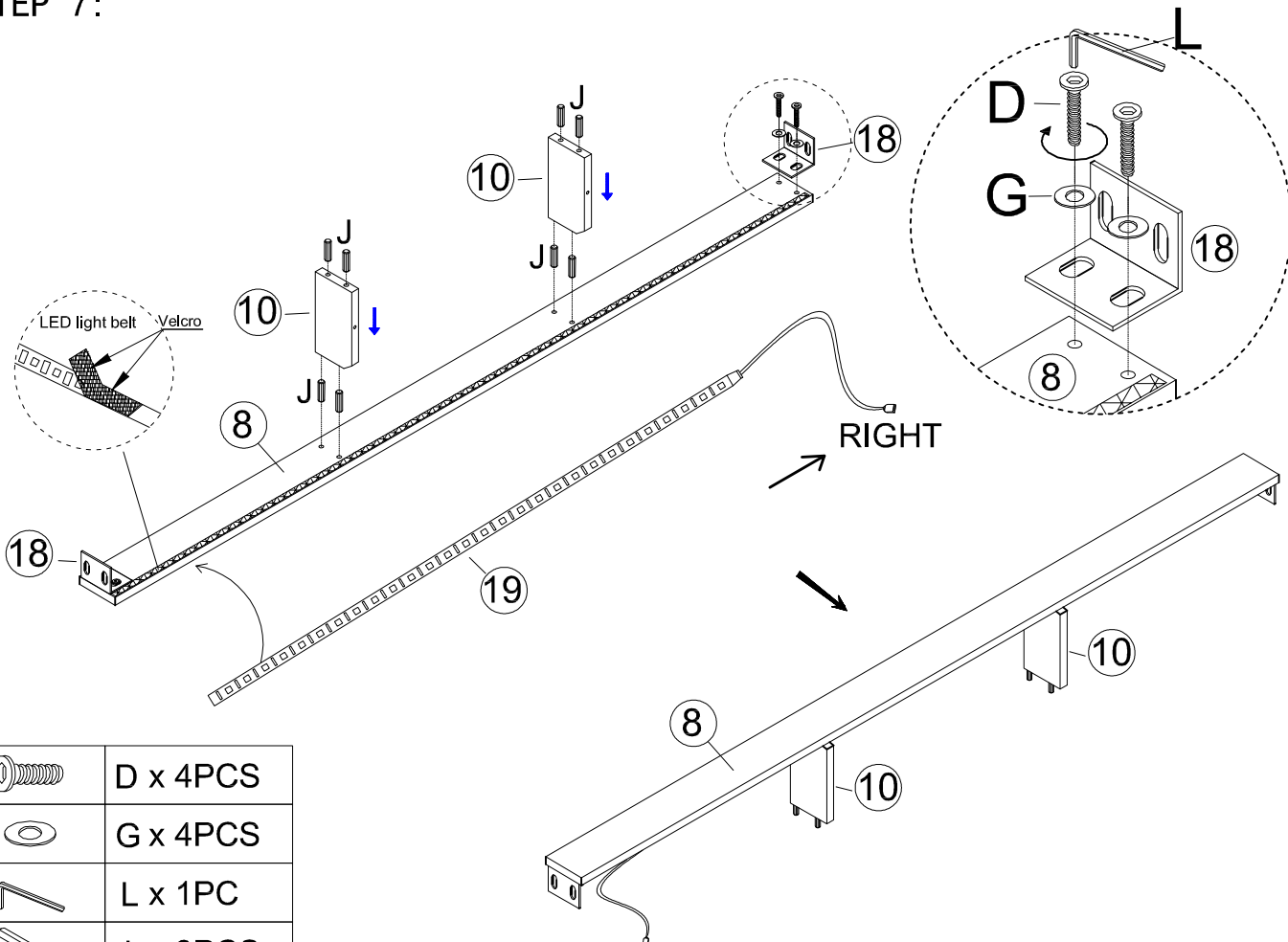

21 x 2

	D x 6PCS
	G x 6PCS
	L x 1PC

STEP 7:





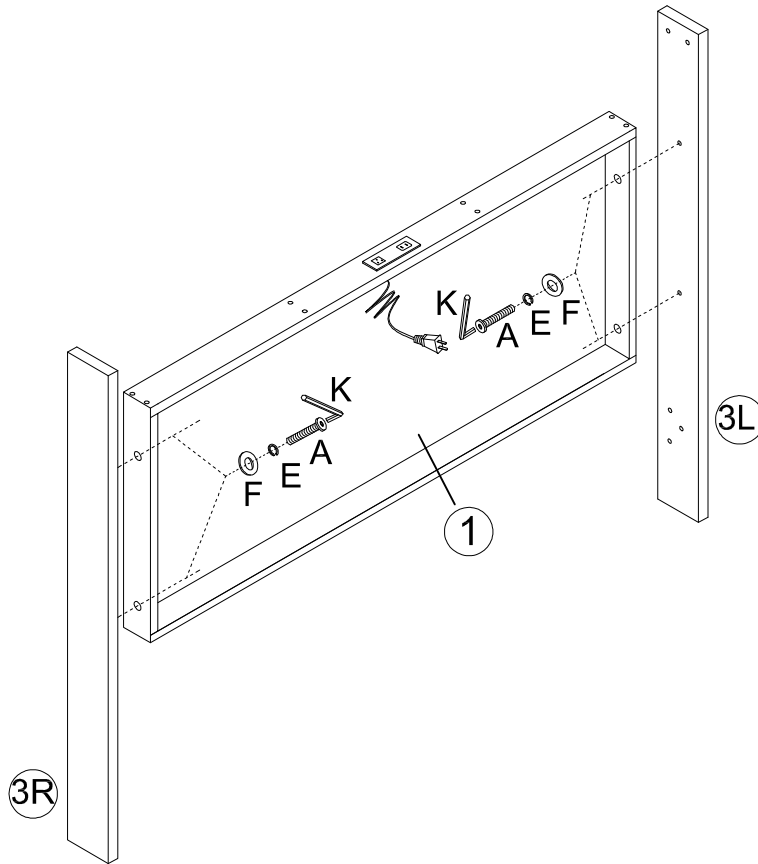

	D x 4PCS
	G x 4PCS
	L x 1PC
	J x 8PCS

Assembly Steps



STEP 8:

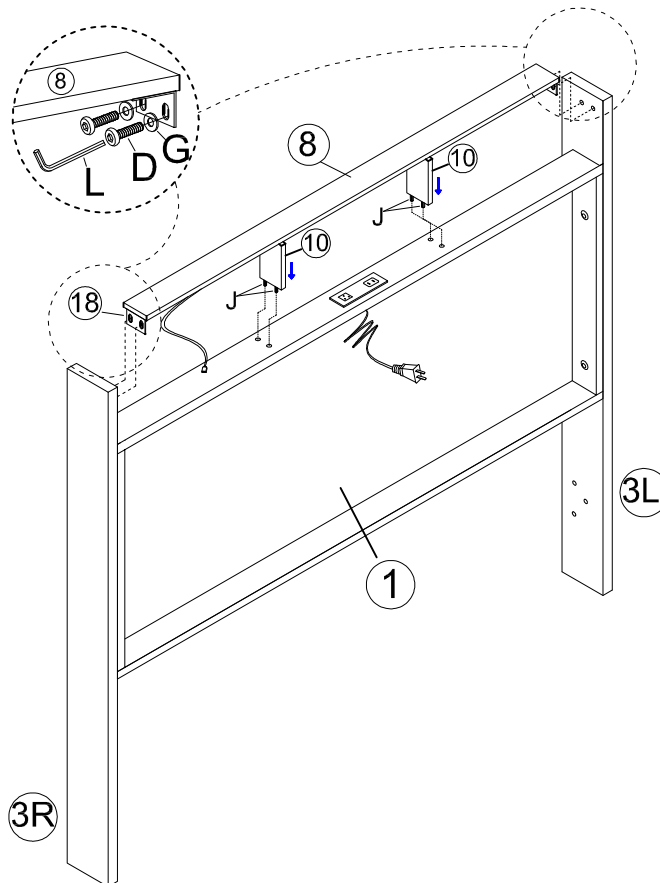

	A x 4PCS
	E x 4PCS
	F x 4PCS
	K x 1PC

STEP 9:



	D x 4PCS
	G x 4PCS
	L x 1PC

Assembly Steps

STEP 10:

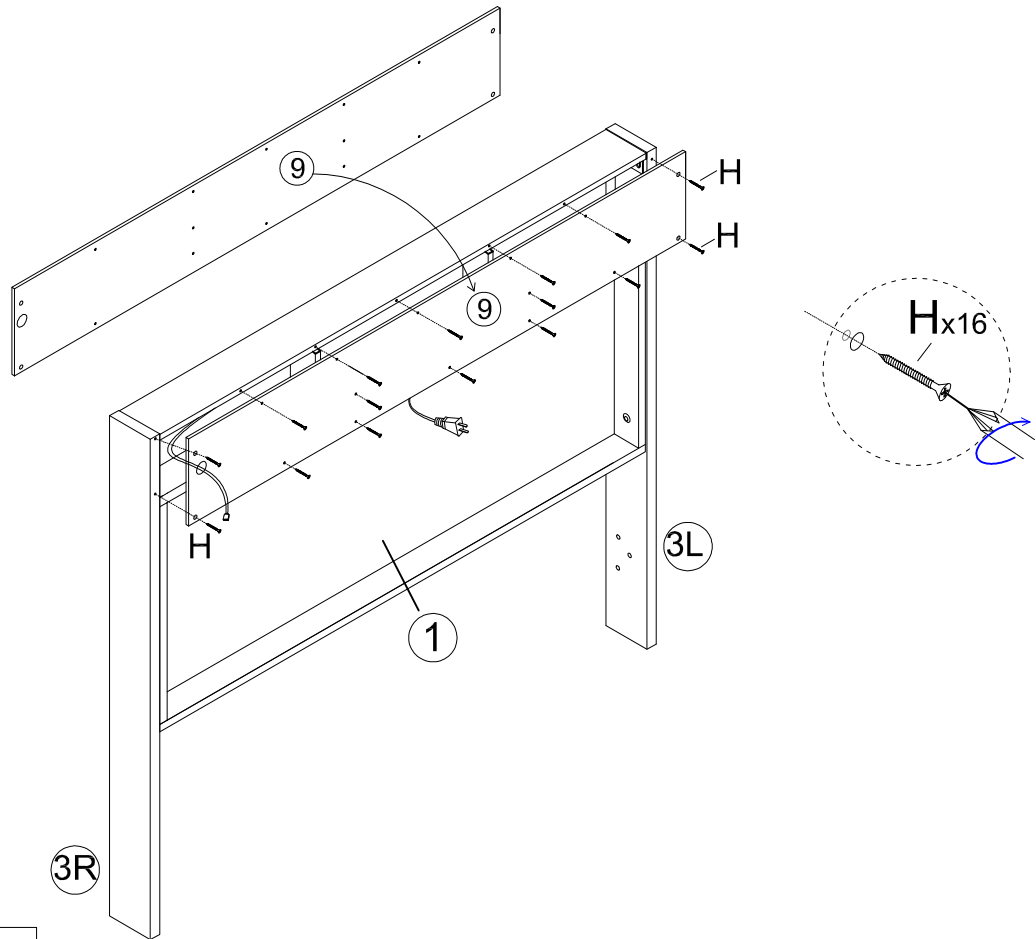

H x 16PCS

STEP 11:

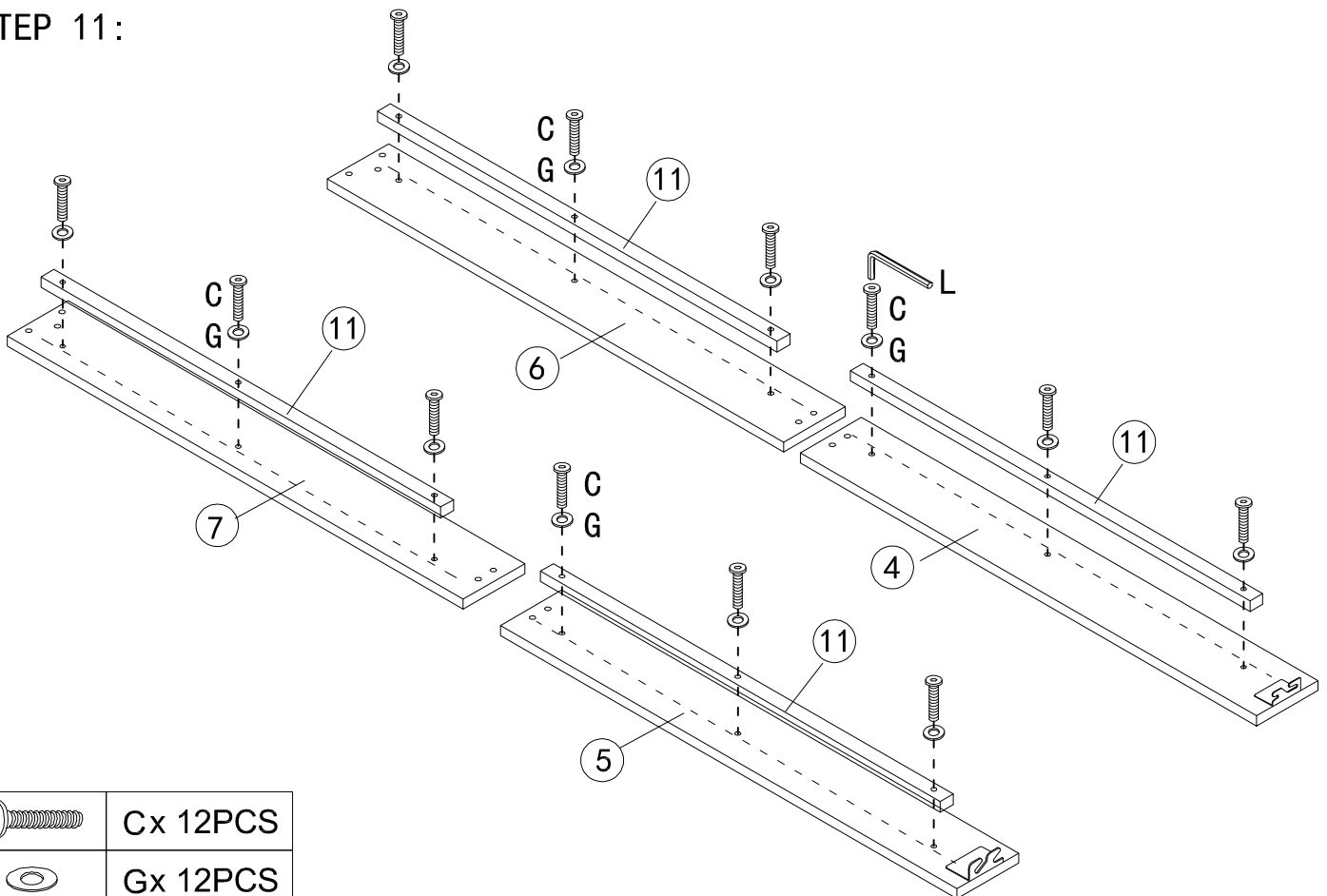

C x 12PCS



G x 12PCS





L x 1PC

Assembly Steps

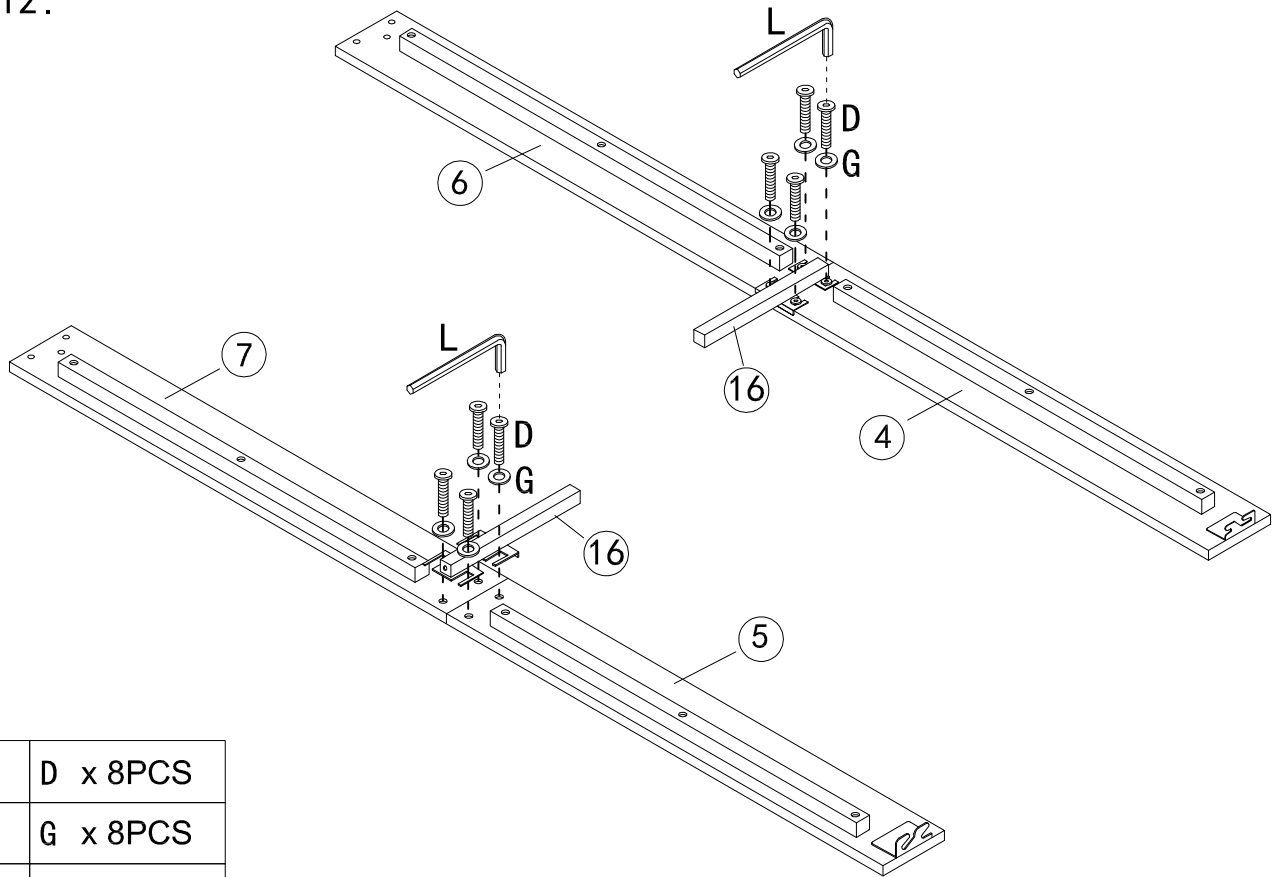



STEP 12:

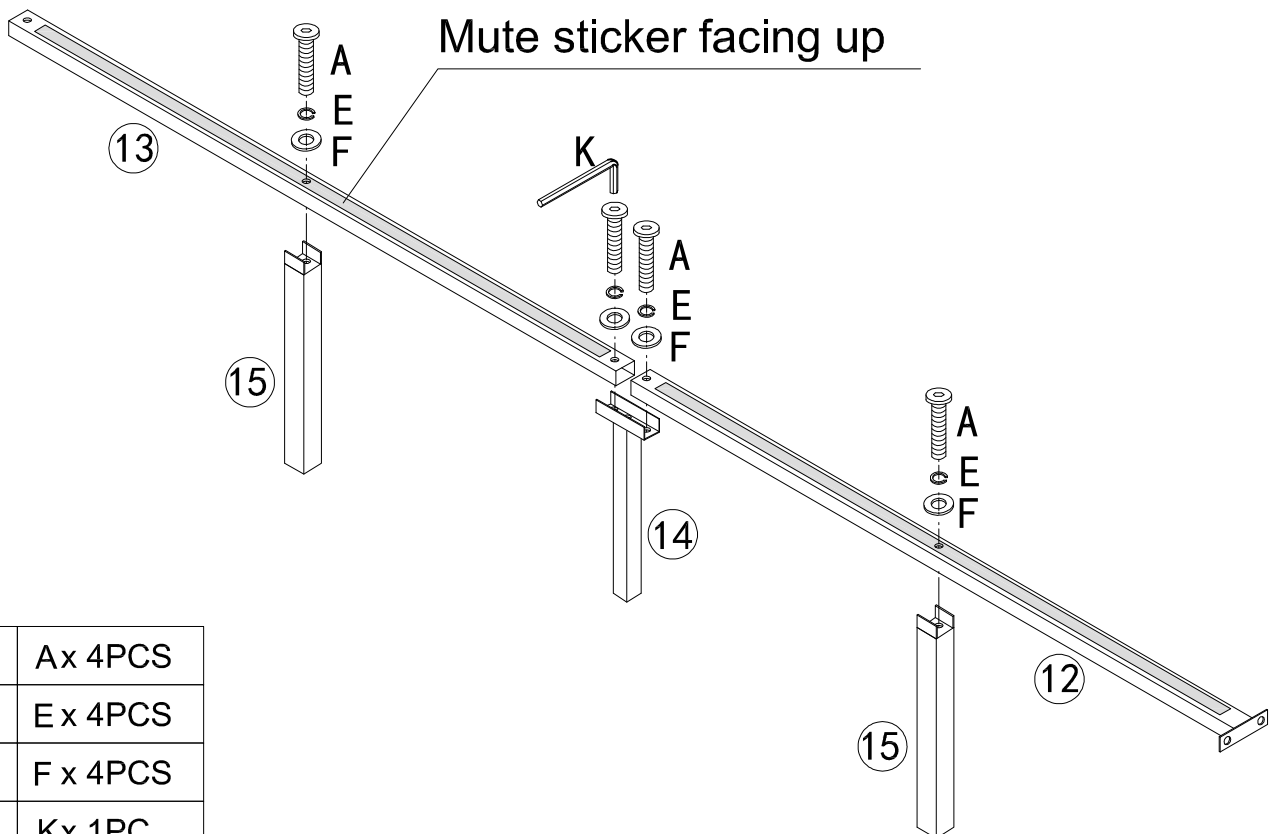

	D x 8PCS
	G x 8PCS
	L x 1PC

STEP 13:





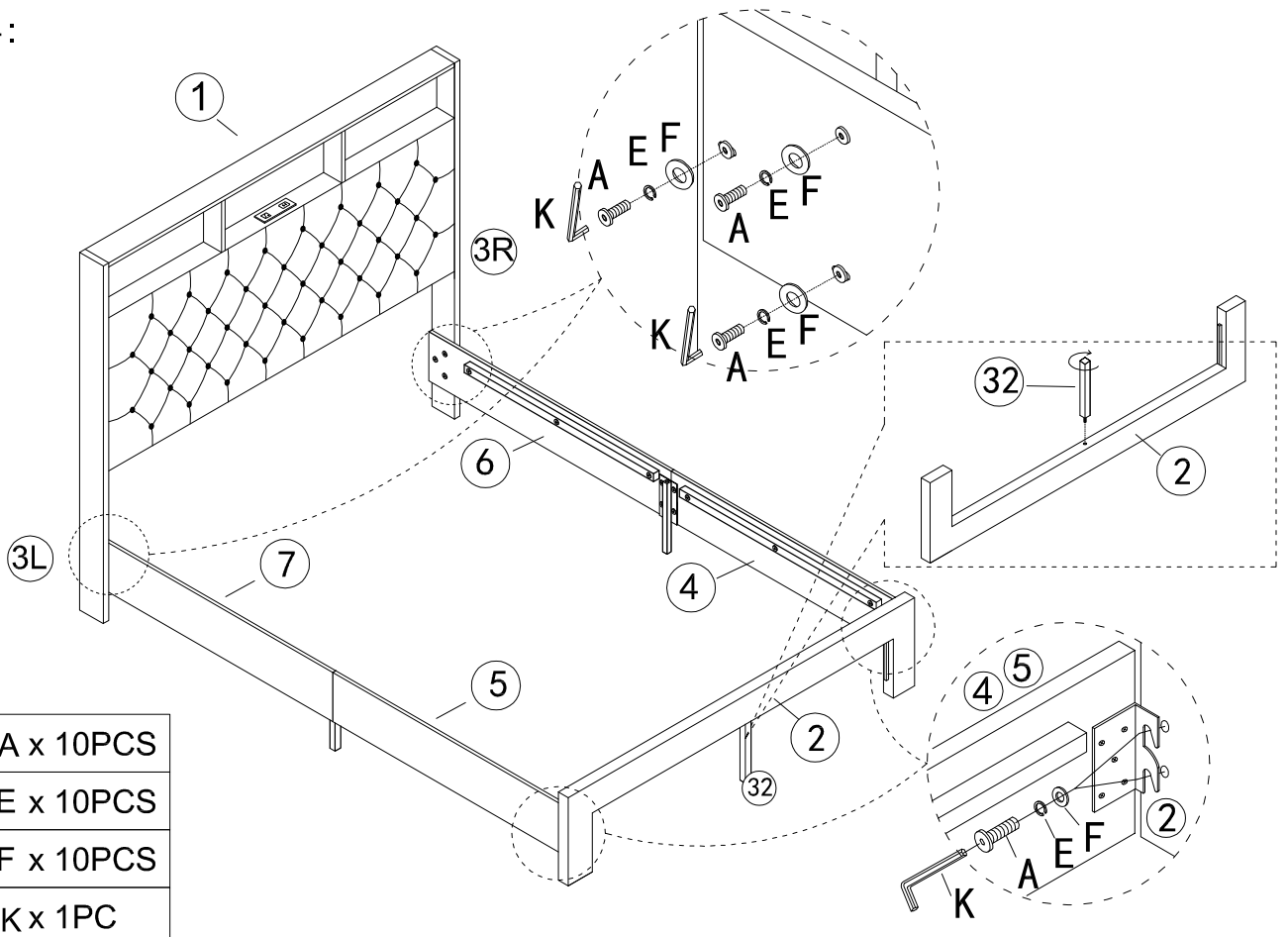

	A x 4PCS
	E x 4PCS
	F x 4PCS
	K x 1PC

Assembly Steps





STEP 14:

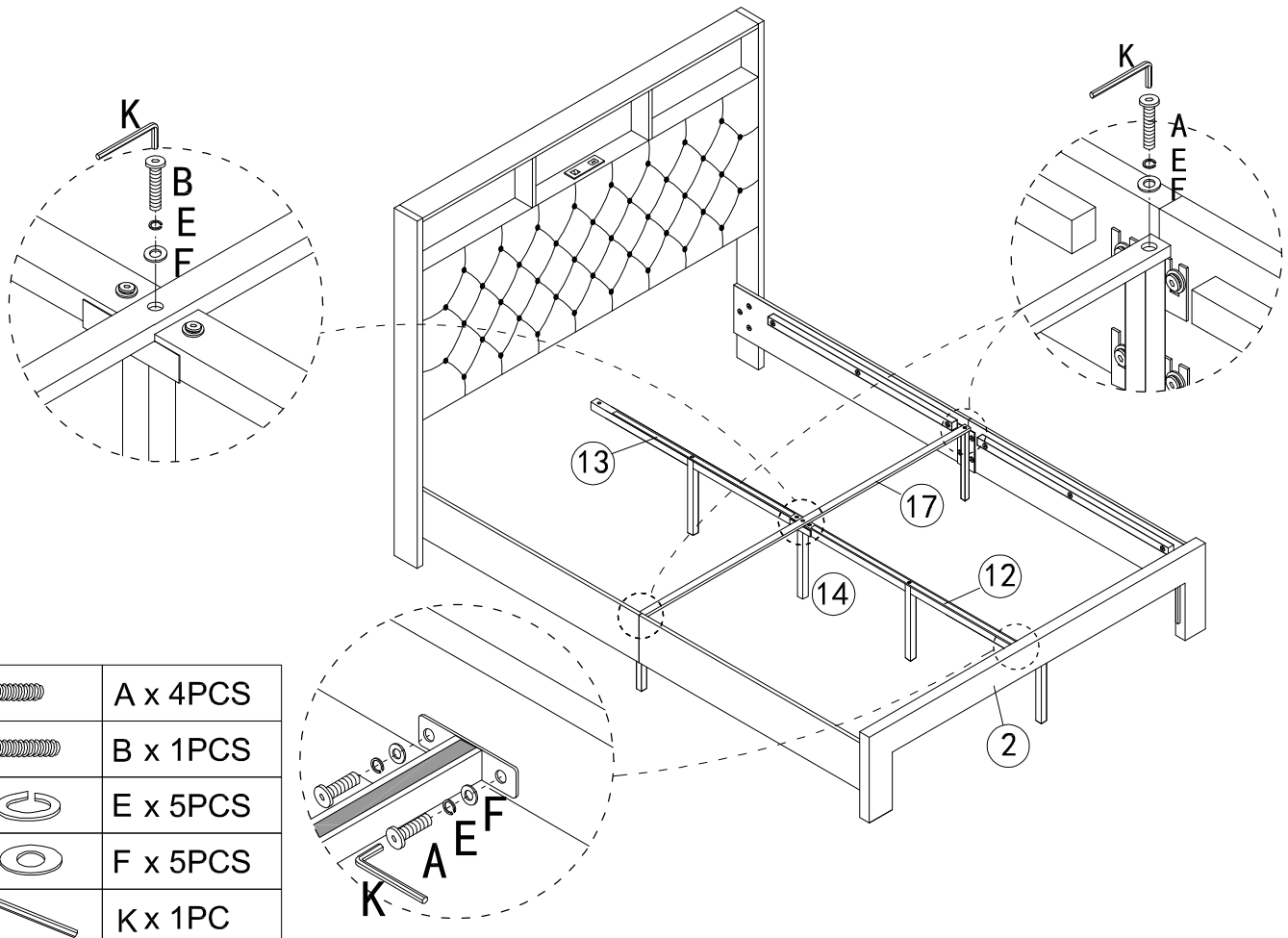

	A x 10PCS
	E x 10PCS
	F x 10PCS
	K x 1PC

STEP 15:



	A x 4PCS
	B x 1PCS
	E x 5PCS
	F x 5PCS
	K x 1PC



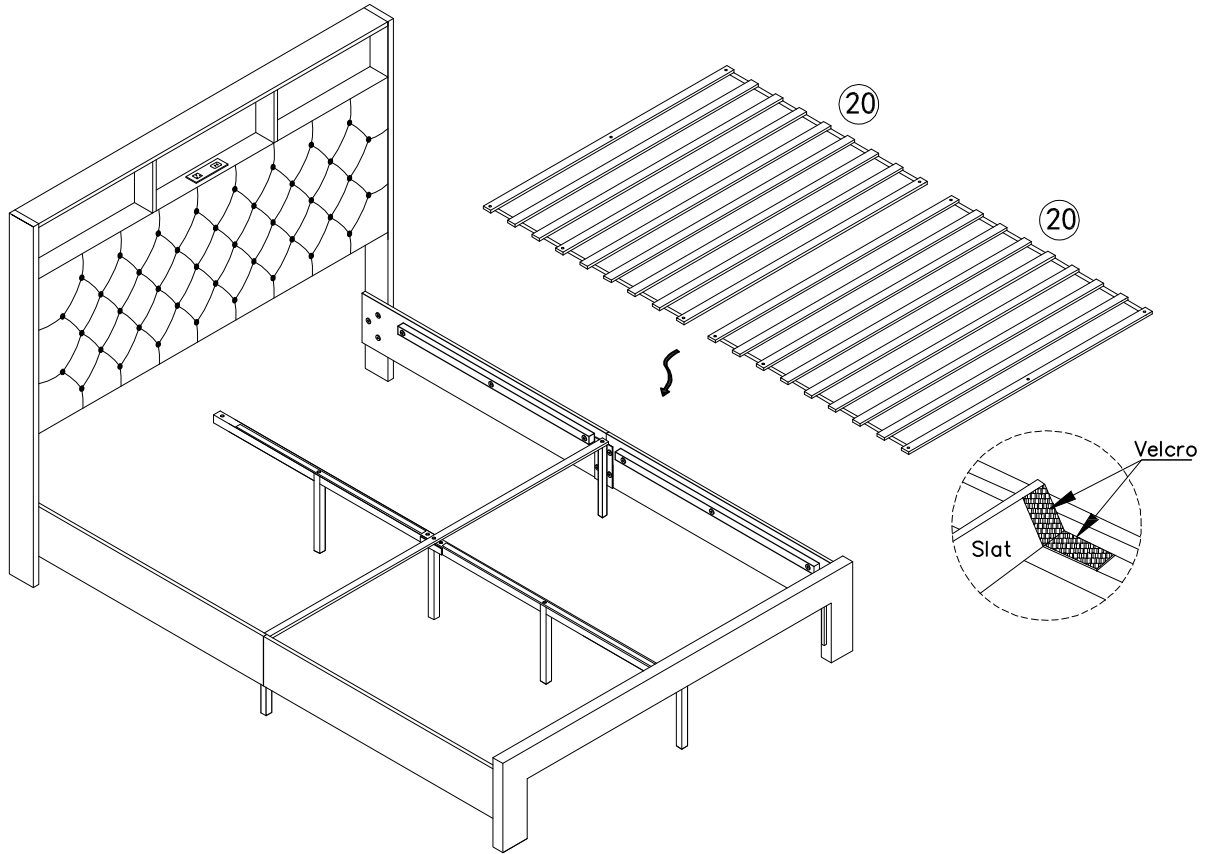

Assembly Steps

STEP 16:

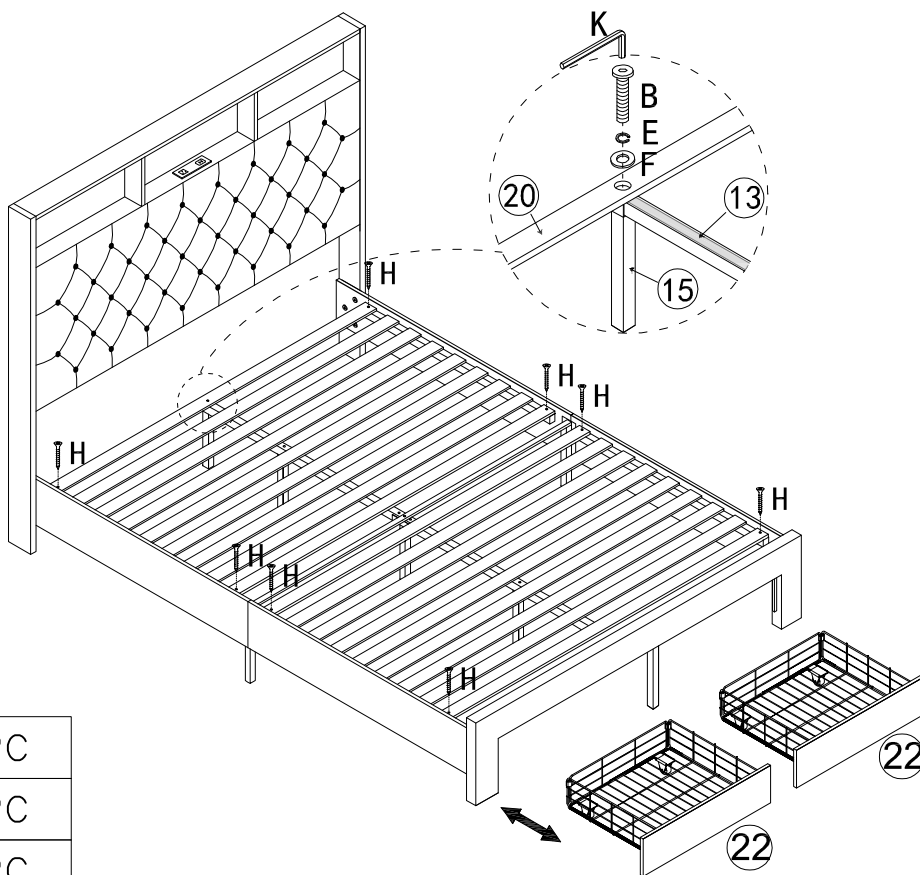

STEP 17:





	B x 1PC
	K x 1PC
	E x 1PC
	F x 1PC

	H x 8PCS
---	----------

Assembly Steps

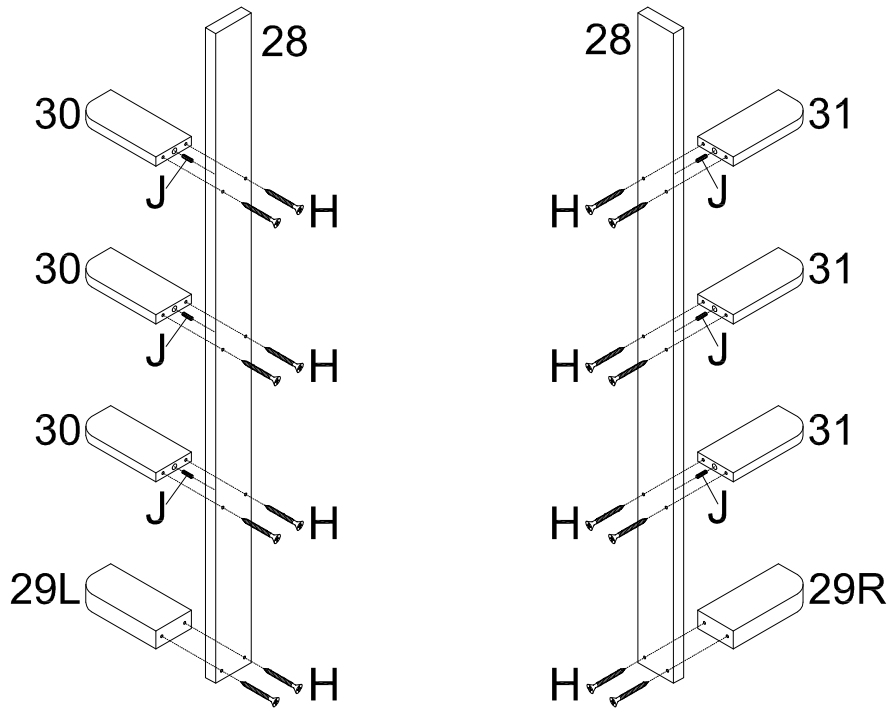
STEP 18:



	J x 6PCS
	H x 16PCS

STEP 19:

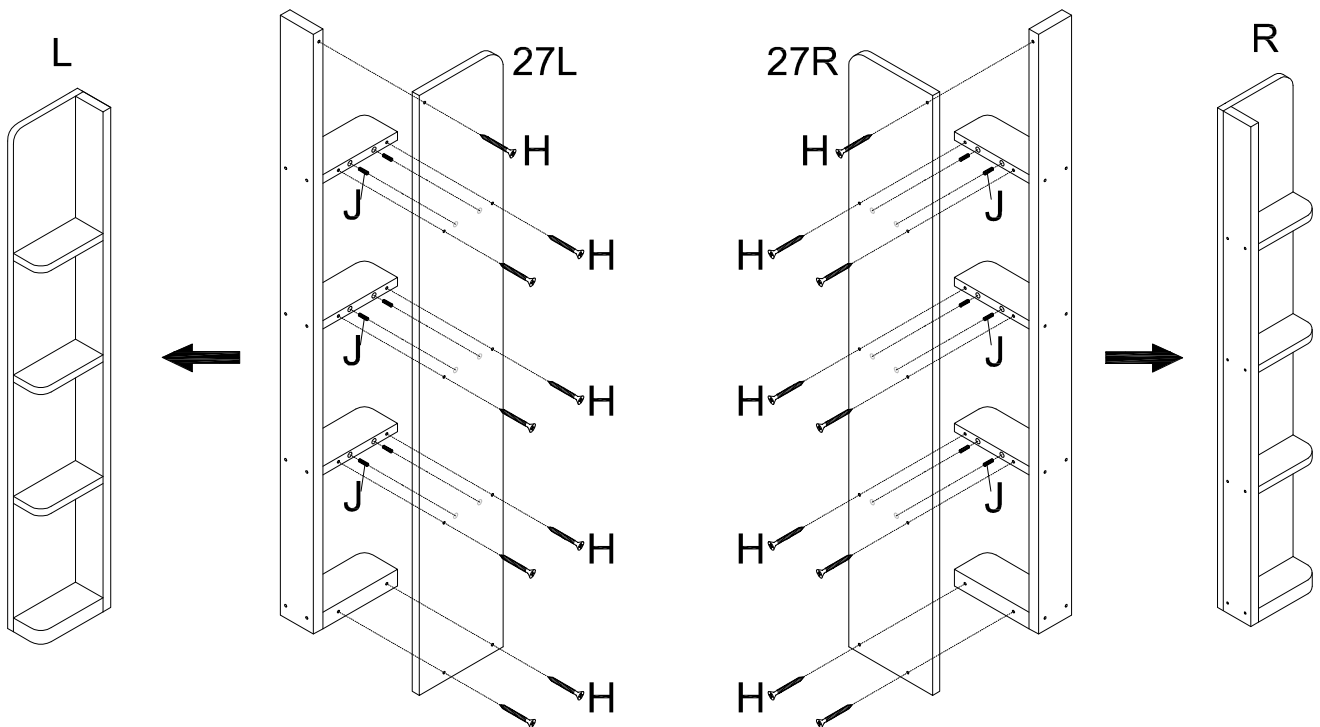

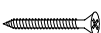
	J x 12PCS
	H x 18PCS

Assembly Steps

STEP 20:

When the components on both sides of the bed are not needed, they can be left uninstalled.
Option A

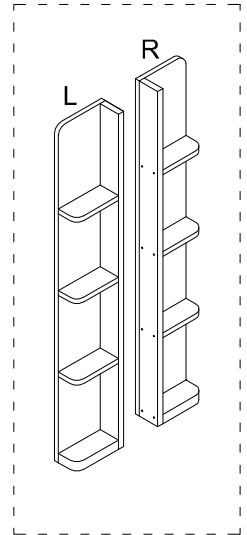
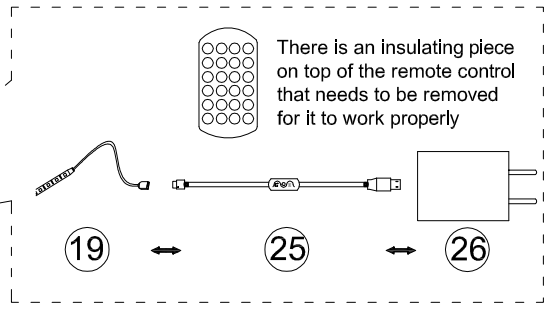
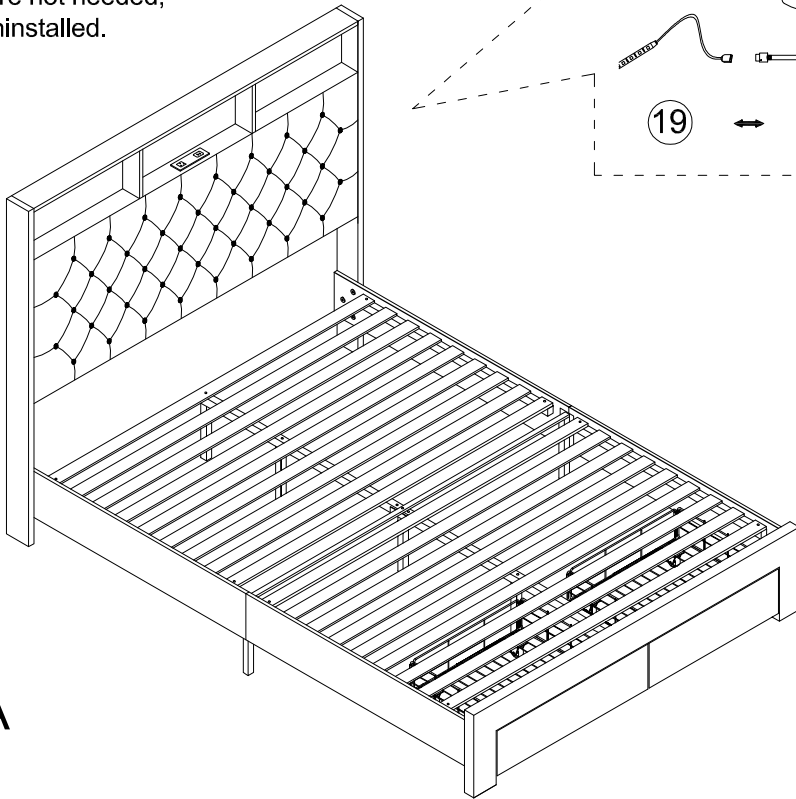

Option A

STEP 21:

When installing the components on both sides of the headboard, locate the reserved installation holes. Align the head of the bed for installation.
Option B

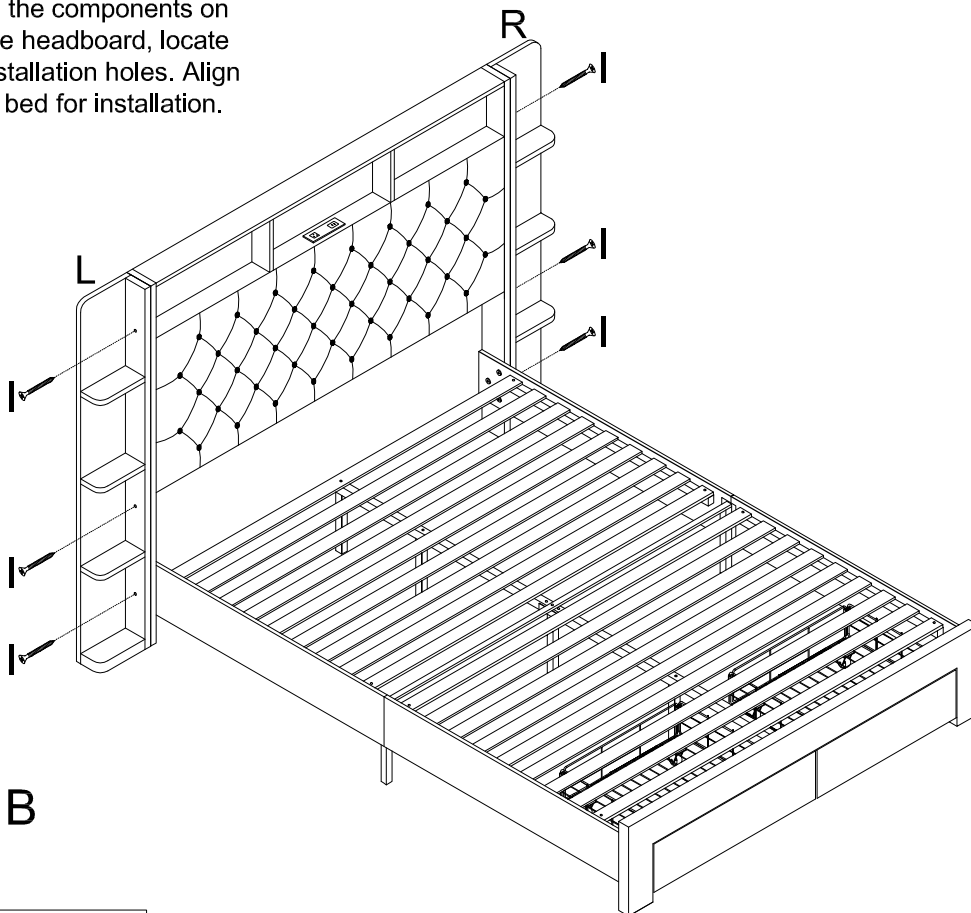

Option B



1 x 6PCS