

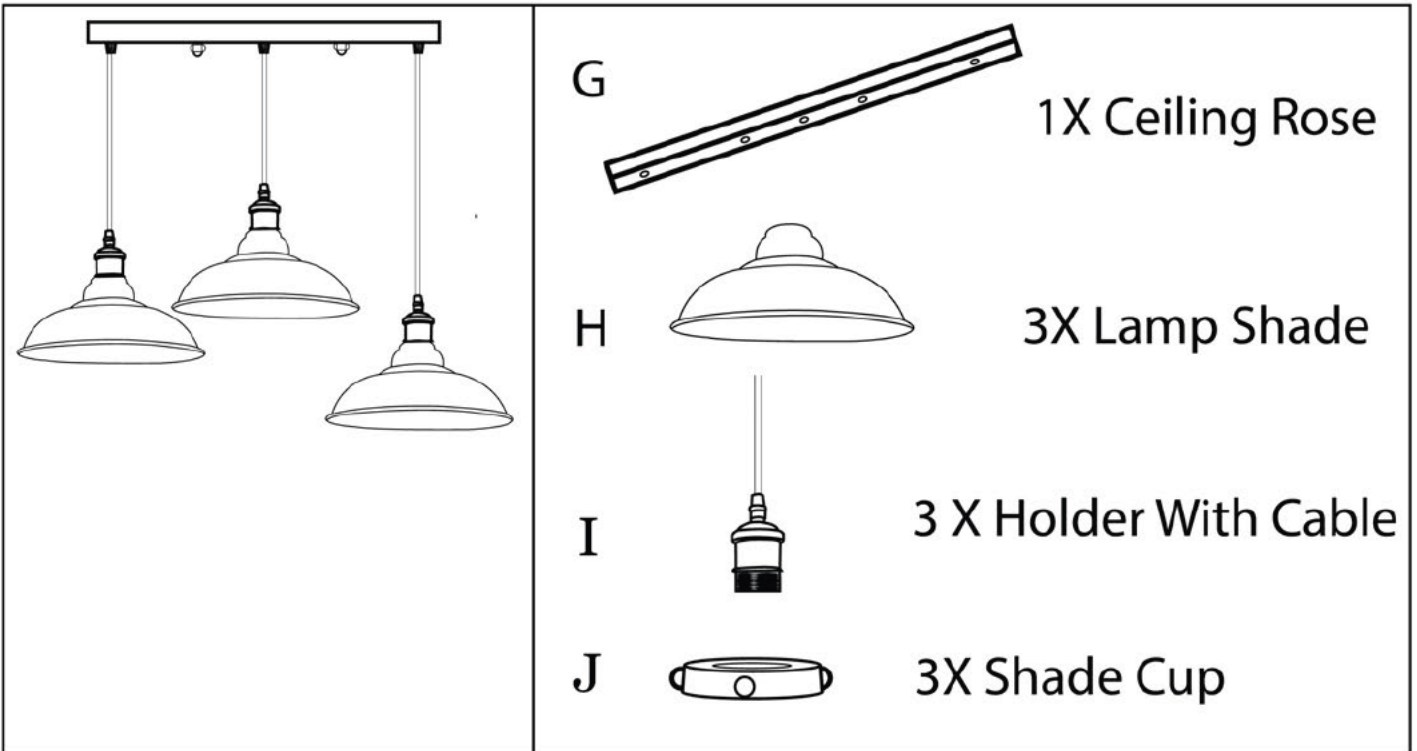

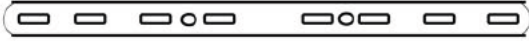





Vintage Metal Pendant Lamp Assembling Instruction



A		1
B		2
C1		3
C2		3
D1		2
D2		2
E		2
F		2

Vintage Metal Pendant Lamp Assembling Instruction

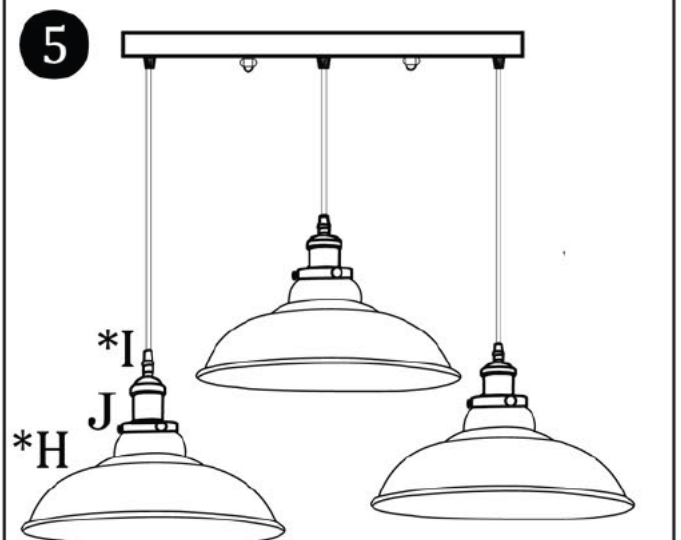
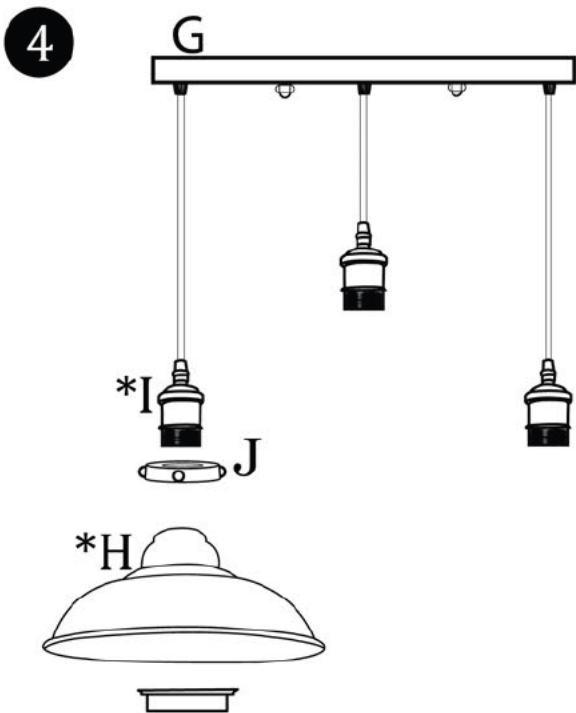
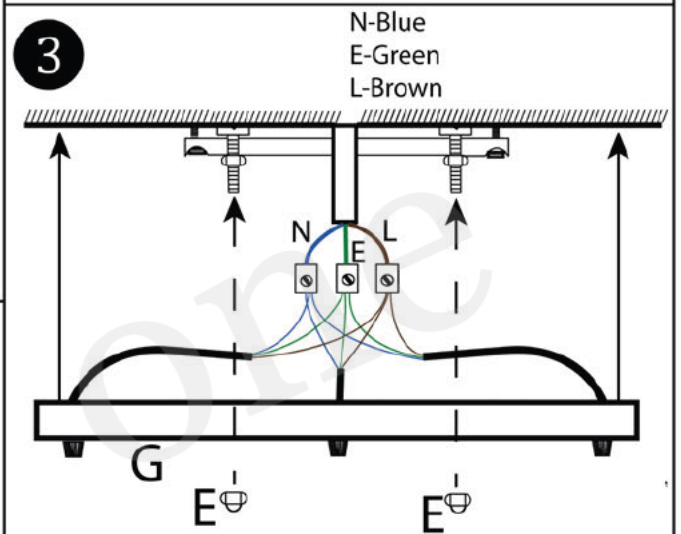
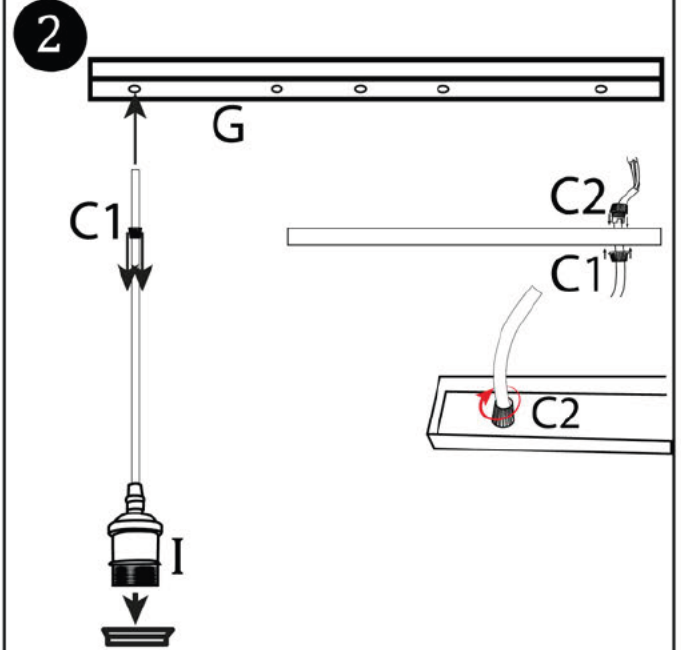
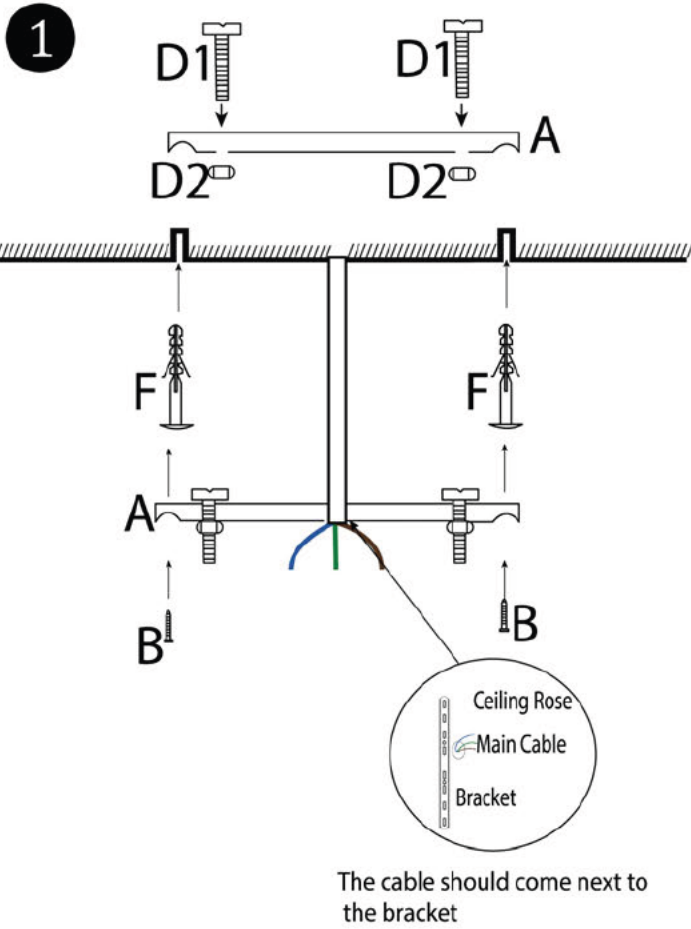

* Please refer the last page for compatible lamp shades & pendant holders

Compatible Pendant Holder and Lamp Shade

Pendant Holder With Cable- H

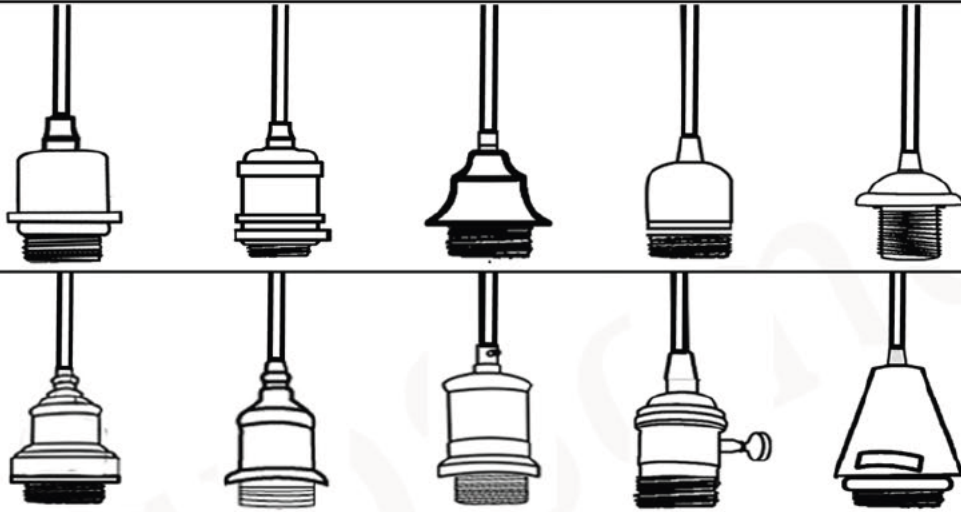

Pendant Lamp Shade - J

