

ASSEMBLY INSTRUCTIONS



Fine Furniture for every stage of life

COFFEE TABLE

ASSEMBLY INSTRUCTIONS

ASSEMBLY TIPS:

1. Remove hardware from box and sort by size.
2. Please check to see that all hardware and parts are present prior to start of assembly.
3. Please follow attached instructions in the same sequence as numbered to assure fast & easy assembly.







WARNING!

1. Don't attempt to repair or modify parts that are broken or defective. Please contact the store immediately.
2. This product is for home use only and not intended for commercial establishments.



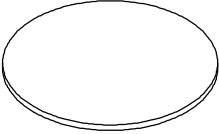
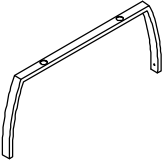
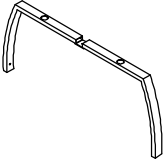

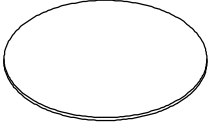



ASSEMBLY TIME 40 MINUTES

PARTS IDENTIFICATION

A	TOP		1PC
B	UPPER LEG FRAME		1PC
C	LOWER LEG FRAME		1PC
D	LEG		4PCS
E	SHELF		1PC
F	CASTER		4PCS

ASSEMBLY INSTRUCTIONS

HARDWARE IDENTIFICATION

1	BOLT (1/4" x 12mm BLK)		9PCS
2	LONG BOLT (ϕ 1/4" x 127mm BLK)		4PCS
3	CAP (20 x 40mm BLK)		4PCS
4	L BRACKET (27 x 27mm)		4PCS
5	WASHER		4PCS
6	ALLEN KEY (4mm)		1PC
7	HEXAGONAL KEY		1PC

ASSEMBLY INSTRUCTIONS

STEP 1 Do not tighten until each step is completed or instructed.

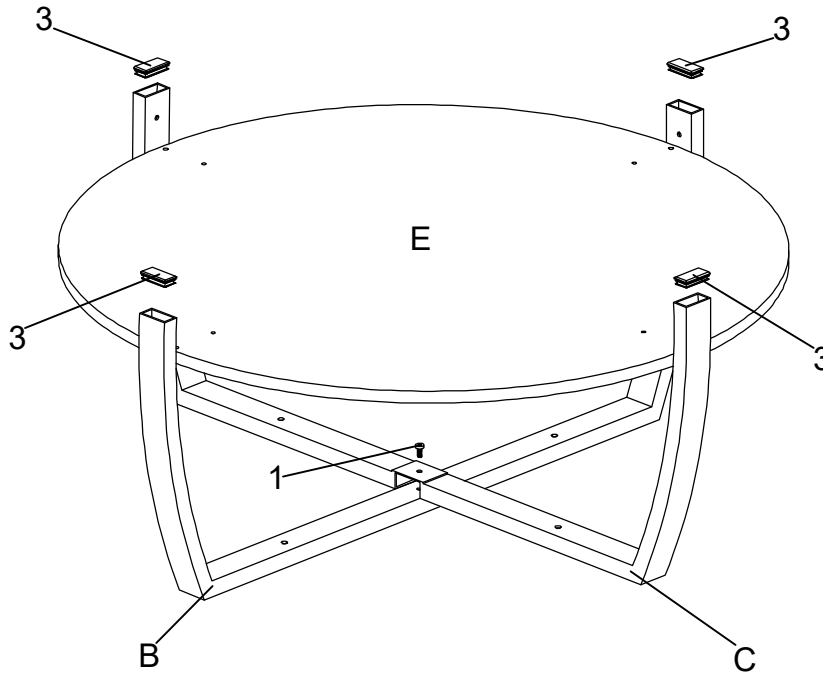

STEP 2

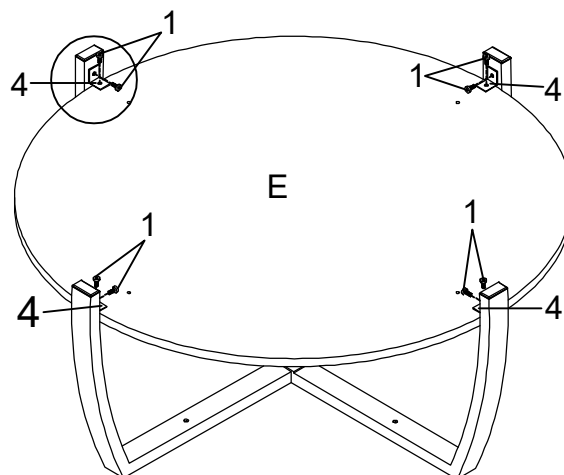
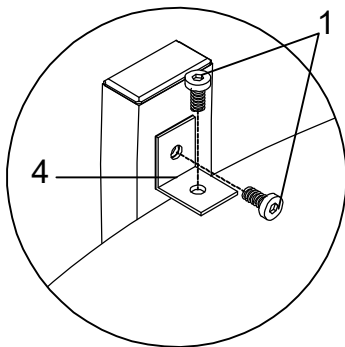

ASSEMBLY INSTRUCTIONS

STEP 3

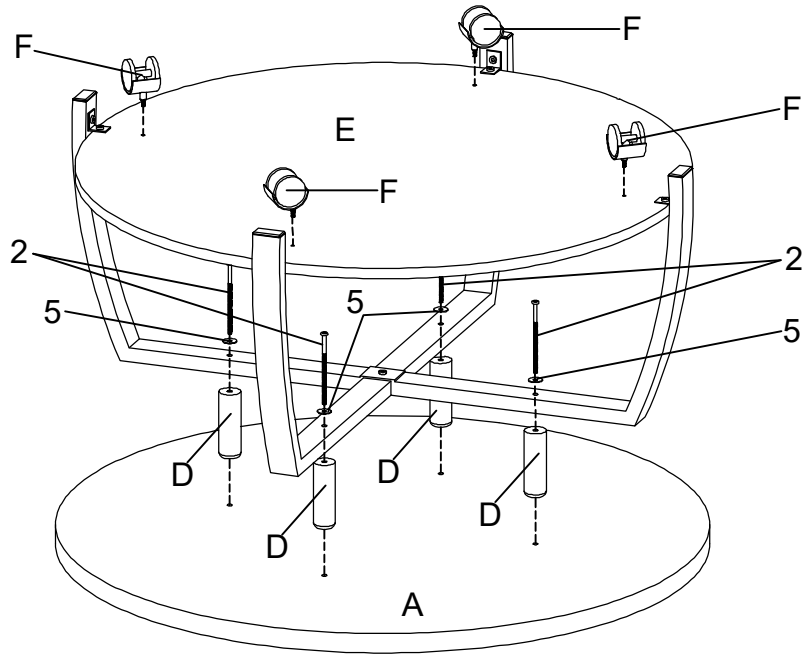

STEP 4

COMPLETE

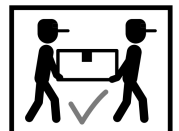
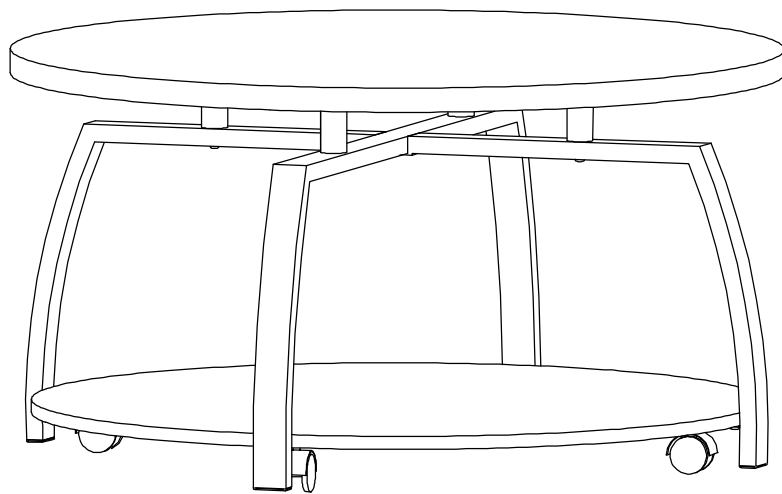

ASSEMBLY INSTRUCTIONS

Product Size : DIA 889 X 464 H (MM)
Product Size : DIA 35" X 18.25"

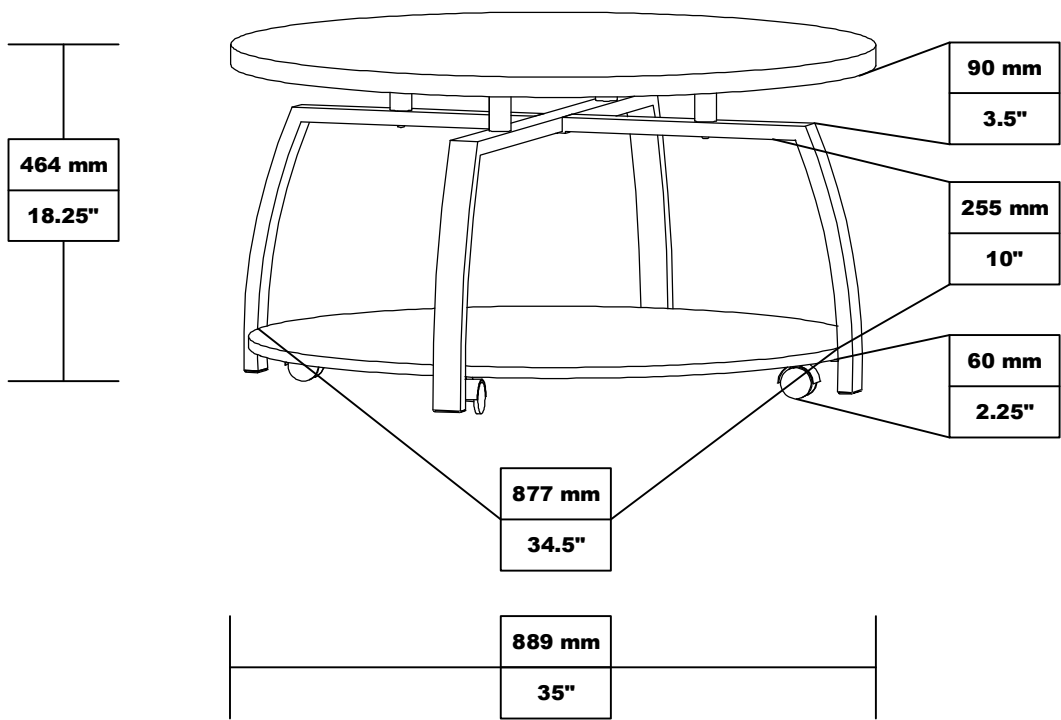

Note : Dimension tolerance $\pm 5\%$