

Owner Manual



OTTOMAN



OTTOMAN

WARRANTY

We strive to offer high quality product and we also try our best to satisfy each customer that order from us, no matter on products or services as needed. Each customer receives a record of their order, such as the order number or item receipt. For any items that are out of warranty period, you may still be able to purchase the replacement parts from our company if they are available.

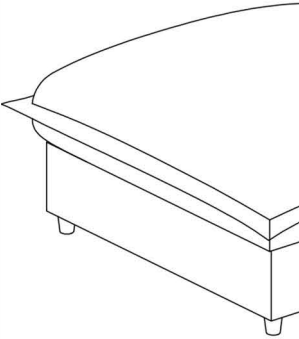

MAINTENANCE AND WARNING

Please read the manual thoroughly
before you start installing.

Please keep the product away from
sharp object.

Packaging and small parts may have
chocking hazard, please keep them away
from children and pets.

Please clean the product according to each
clean code, check the product description
for more information.

Please keep the product away from
fire.

If you have any other questions, please
contact us, we will be glad to help you out.

If the product is placed under direct
sunlight, the pattern or color might fade
away overtime.

Check the product periodically to make
sure everything is secured and tightened.

Always use proper tools for installation.

Do not jump on the product.



Around 5 min

PRODUCT DESCRIPTION

High-Quality Chenille Fabric: The ottoman is upholstered in a soft, smooth chenille fabric that provides a luxurious feel while enhancing your home décor.

Sinuous Spring Support: The sinuous spring construction adds elasticity and resilience to the cushion, offering enhanced support and comfort.

Dual-Layer Design: A dual-layered cushion design ensures optimal softness and firm support, perfect for lounging or as extra seating.

Modular Flexibility: This ottoman is part of a modular system, allowing it to easily connect with other components, making it adaptable to your living space.

Multi-Purpose Functionality: Whether used as a footrest, additional seating, or a stylish accent piece, this ottoman offers both style and function for any room.

EXPLODED VIEW

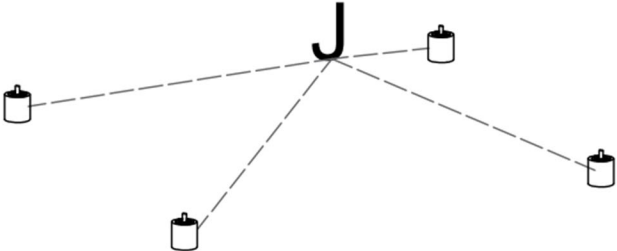
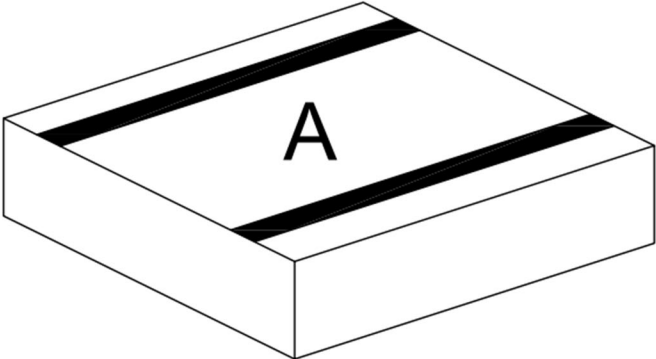
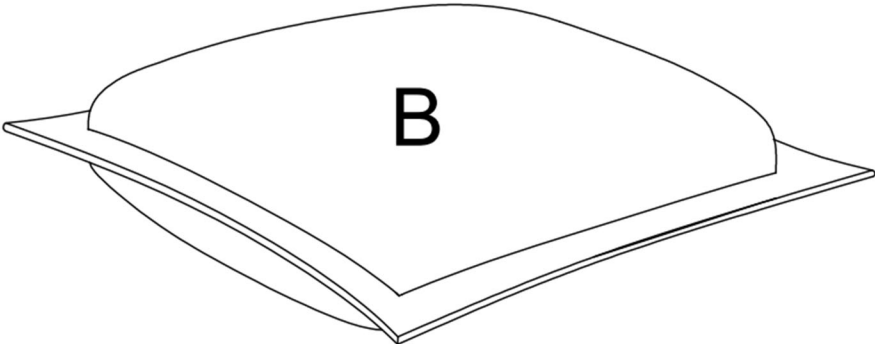

PARTS

A*1

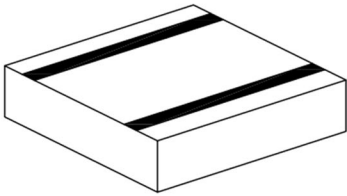

Ottoman frame

B*1

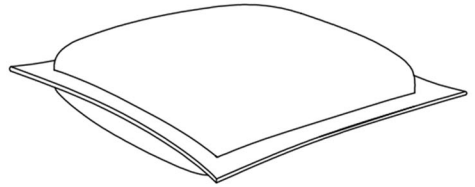

Seat cushion

HARDWARE

TOOL LIST

NOTE: Designated with (★) We provide additional spare parts in the hardware package

J*4

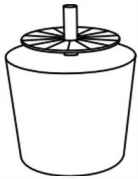

Legs

M*1

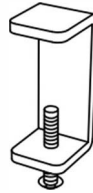

Hook

Please make sure all hardware & packing material fitting the list. Especially some small accessories may be missing during transportation. Please contact us if you have any question.

step 1

Flip over the ottoman frame (A) as shown, twist the legs (J) clockwise into each corner.

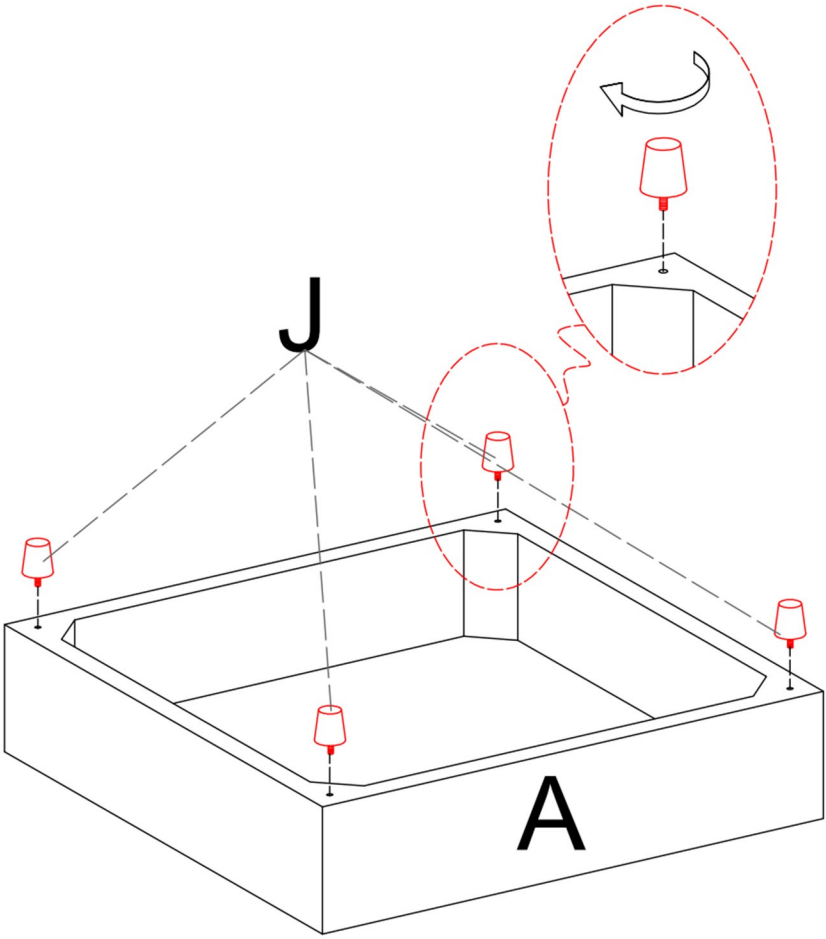

step 2

Place the ottoman cushion (B) into the ottoman frame (A) as shown.

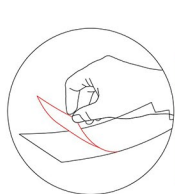

Tear off the Velcro strip cover before pasting.

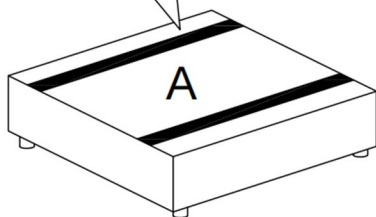
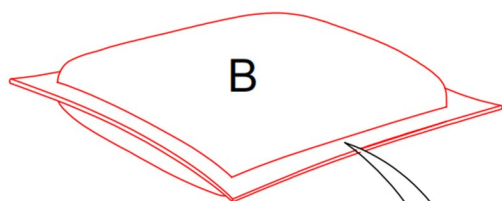
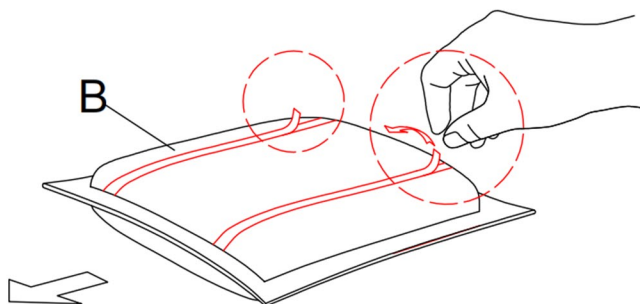

step 3

There is one metal connector inside each package the metal connector is used to connect sectional sofas together, if you are only using one piece of the sectionals, the connectors will not be used during the assembly. if you want to connect sectionals together, please use the connectors before the headrest is inserted.

place the sectionals upside down on a clean surface, and bring both of the parts as close as possible, make sure both of the parts are aligned, then fix the connector at 40 cm (about 16 inches) away from the front and back edges, then tighten the connector.

