

# ASSEMBLY INSTRUCTIONS

Item NO.: YJJ250034

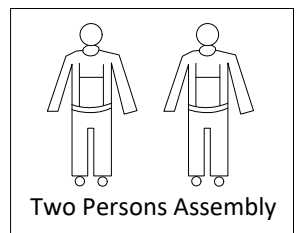

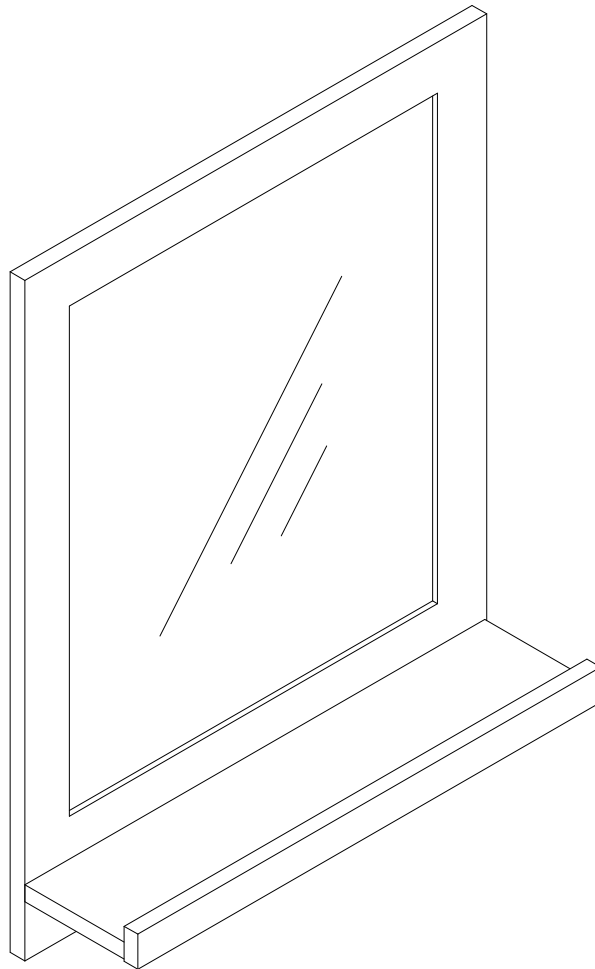
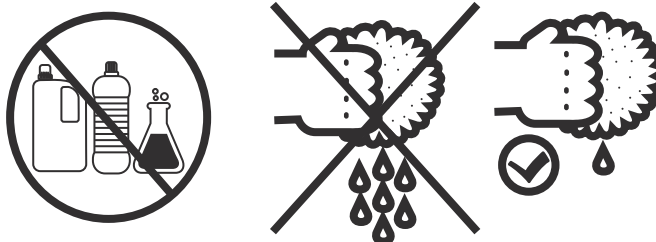
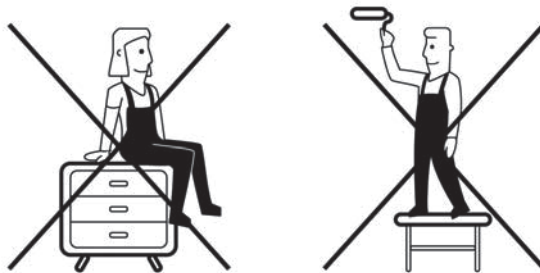
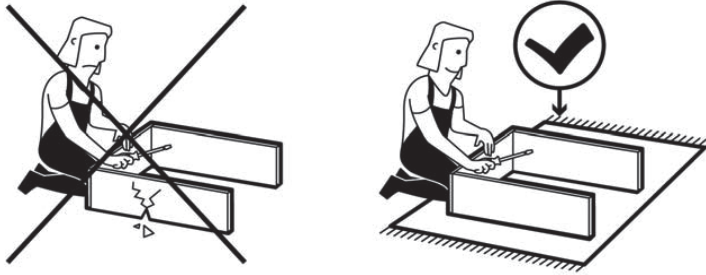
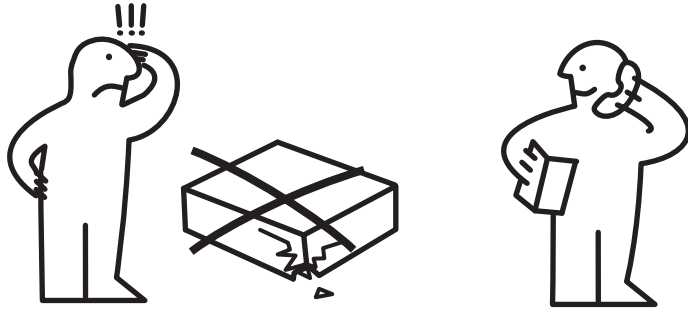

Laying out all the parts and hardware and identifying each part as shown below. It may help you when you assemble the item.

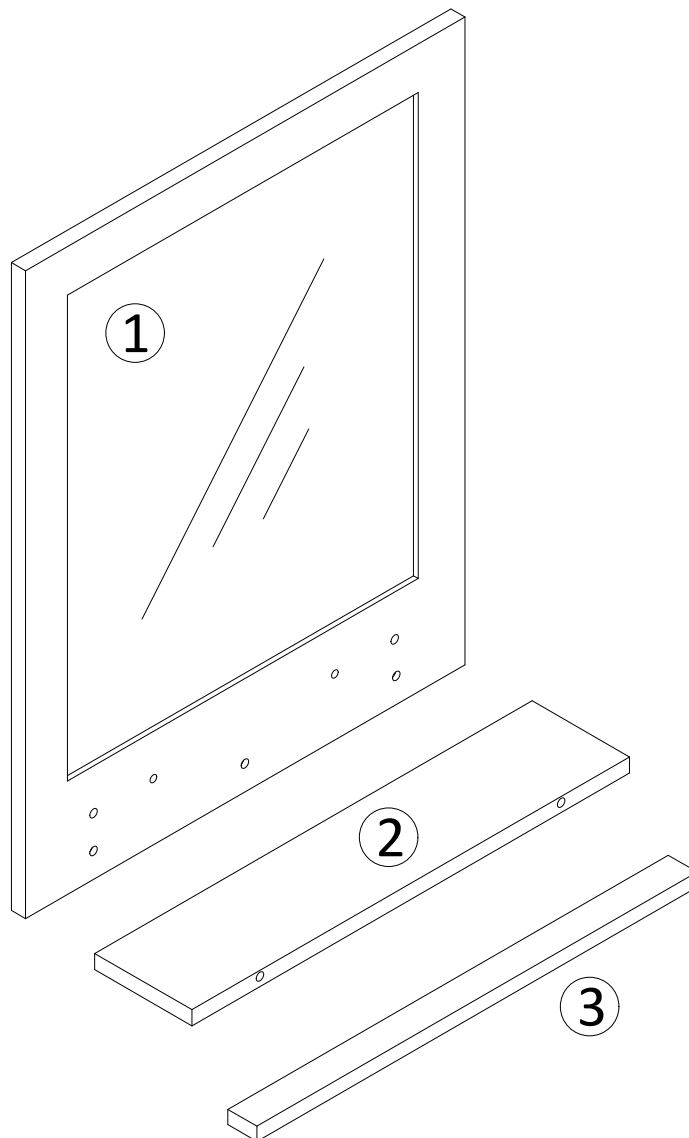

① × 1

② × 1

③ × 1

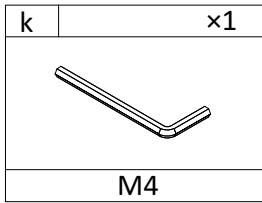
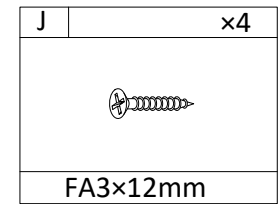
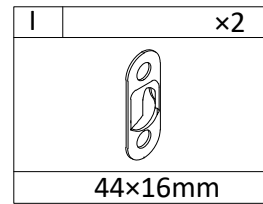
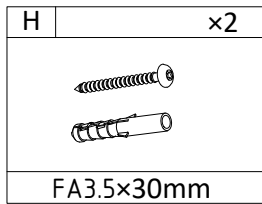
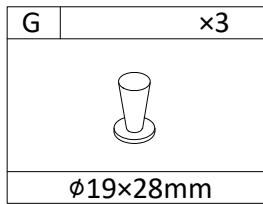
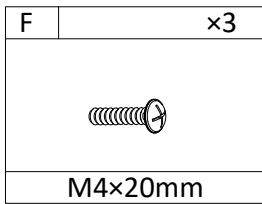
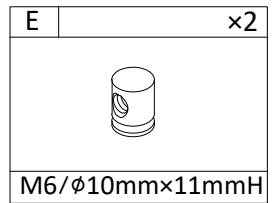
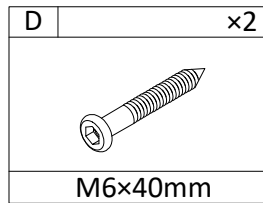
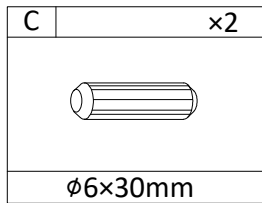
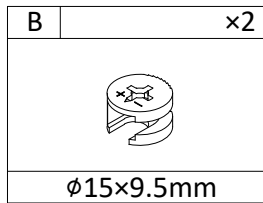
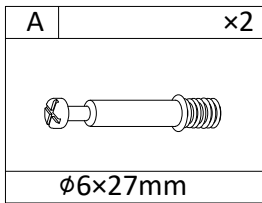

1

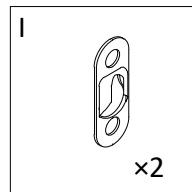
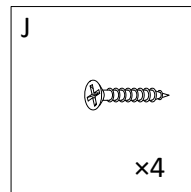
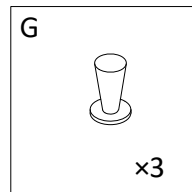
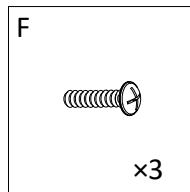
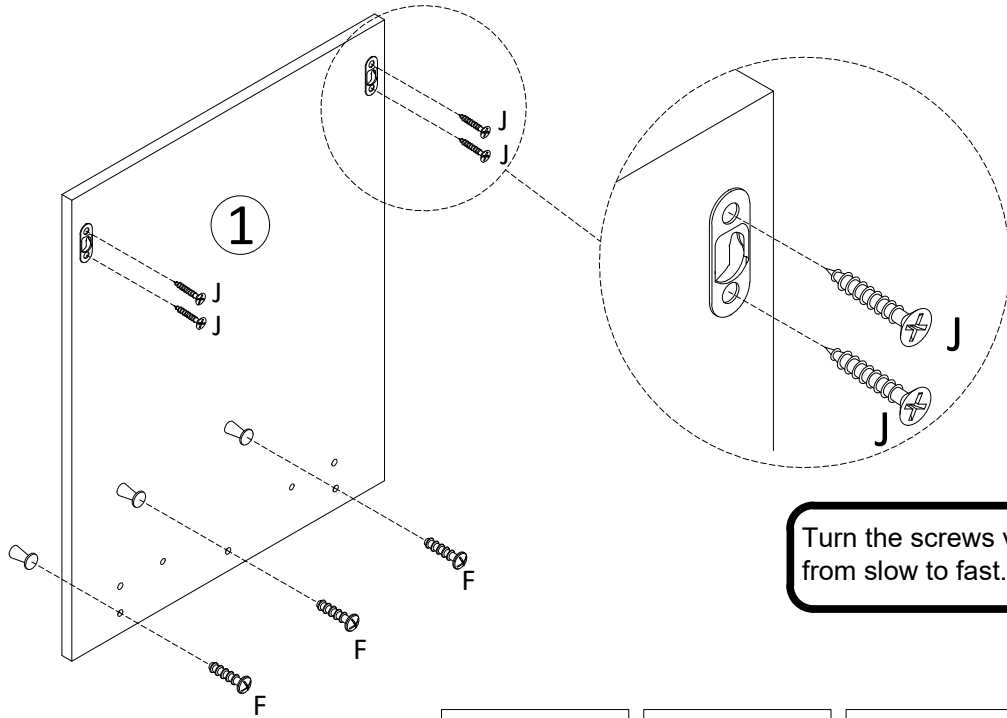

2

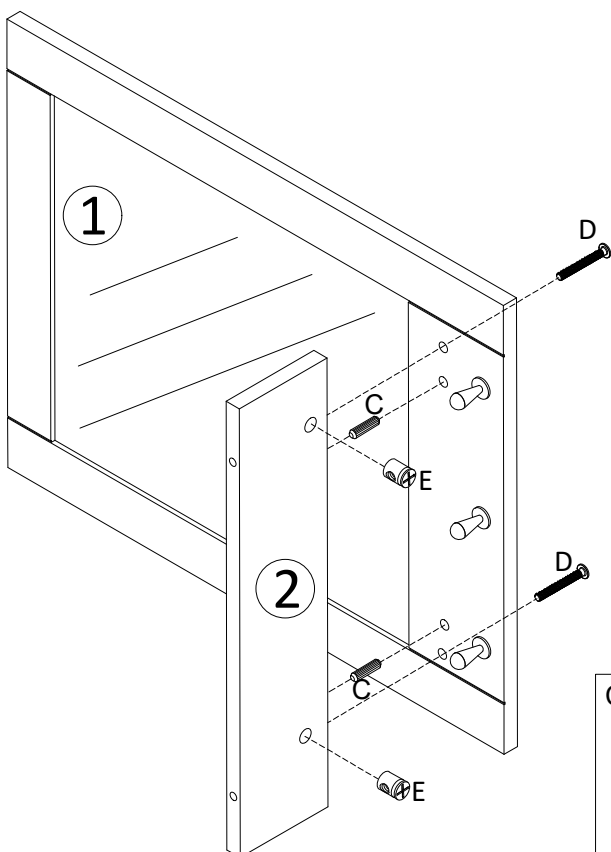

Turn the screws vertically from slow to fast.

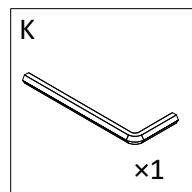
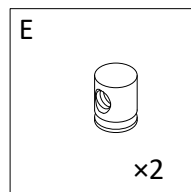
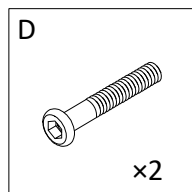
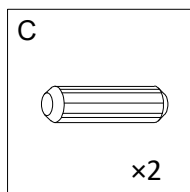
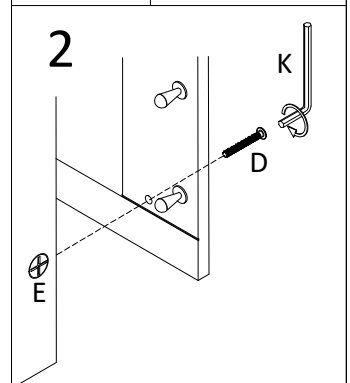
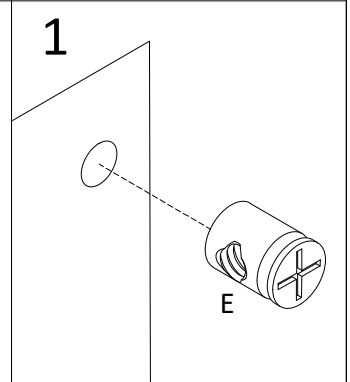

3

Turn the screws vertically from slow to fast.

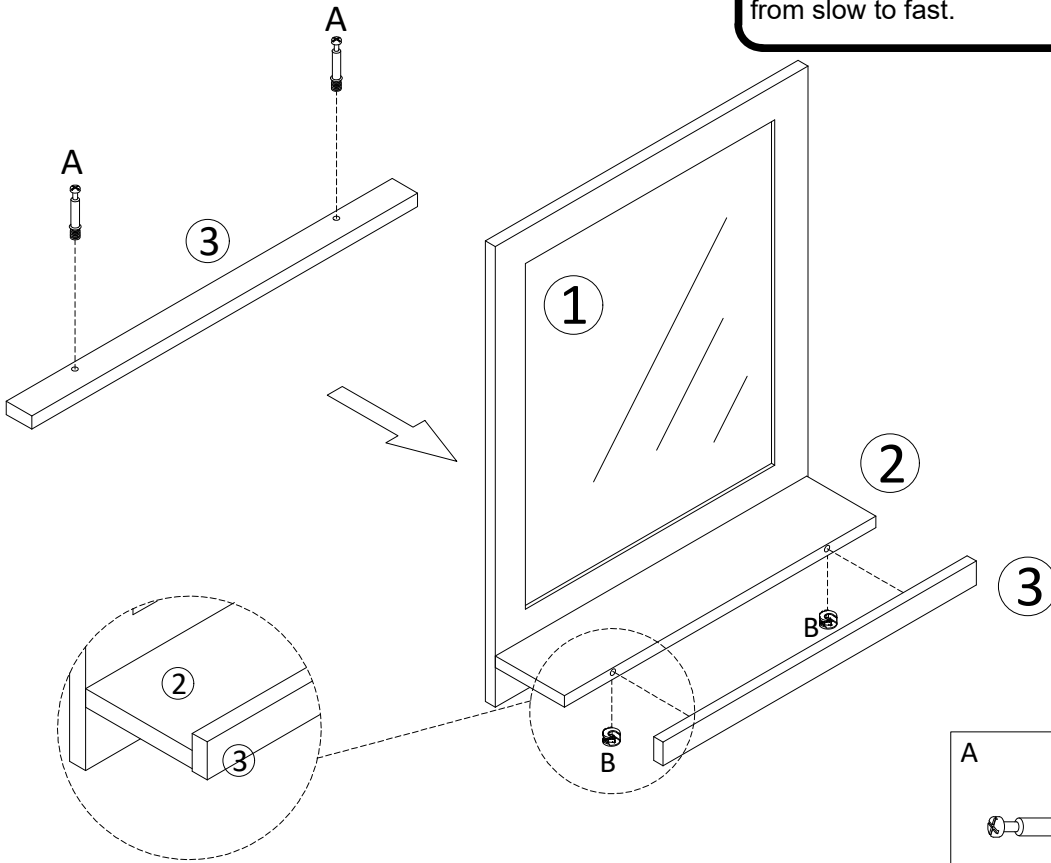

1

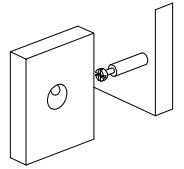

2

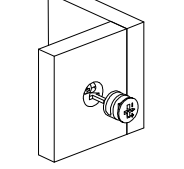

3

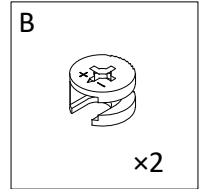
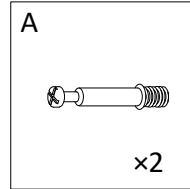
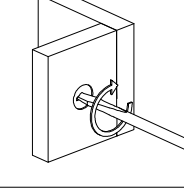

4

Note: If you'd like to hang the mirror on the wall, the step 3 and 4 show how you fix it on the wall.

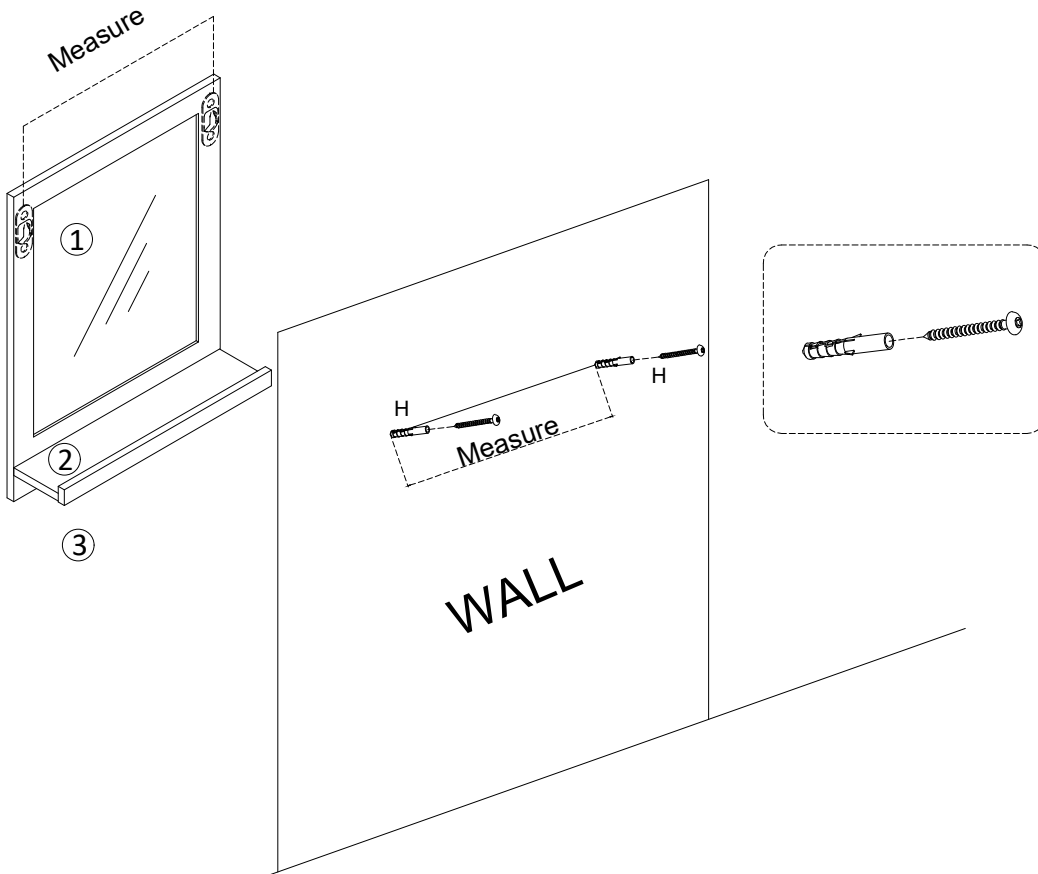

1

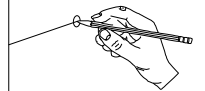

measure the length

2

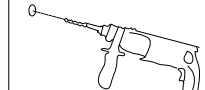

Punching two holes on the wall with drill (not provided)

3

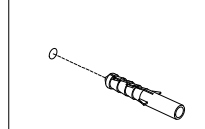

Fixing the plastic anchors in the wall

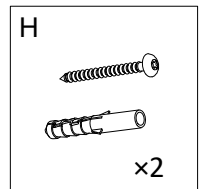

5

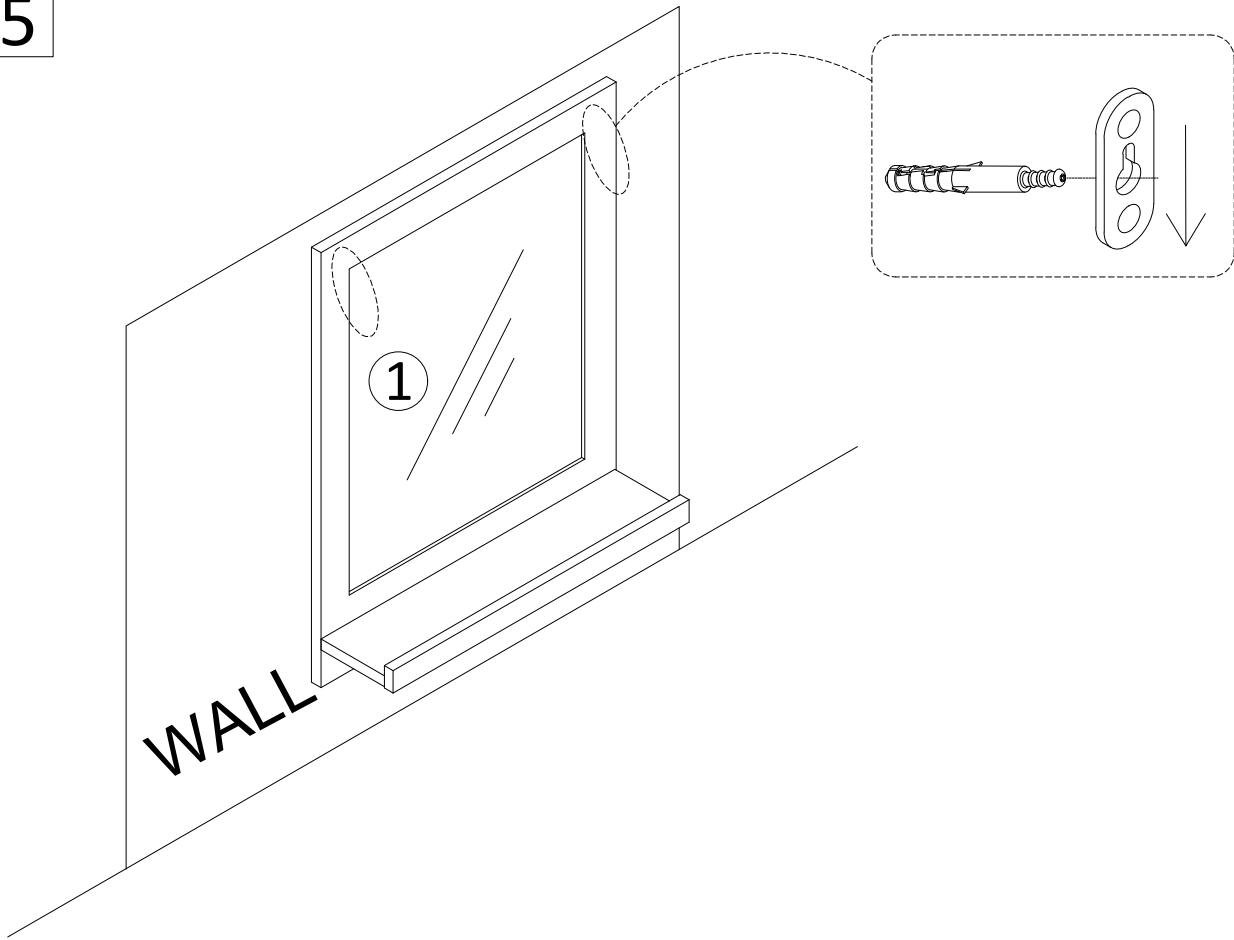

6

