



ASSEMBLY INSTRUCTIONS

**MODEL : 0361A/B & 0362A
YLIME
VANITY MIRROR & 3
DRAWER VANITY (L&R)**

**(BOX 1)
BOX OF VANITY MIRROR**

NO	ITEM	QTY
A	VANITY MIRROR 	1 PC

**(BOX 2)
BOX OF 3 DRW VANITY (L&R)**

NO	ITEM	QTY
B	VANITY (L&R) 	2 PCS
C	Tempered Glass Shelf 8mmx330mmx644mm 	1 PC

**(BOX 3)
BOX OF STOOL**

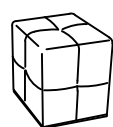
NO	ITEM	QTY
D	STOOL 	1 PC



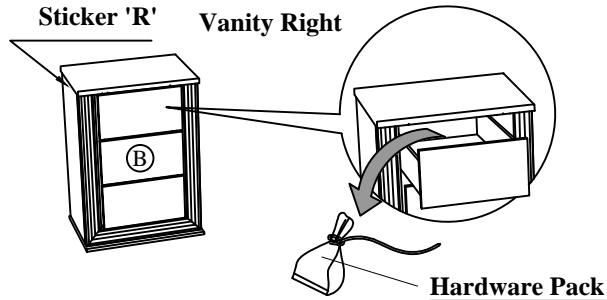

STEP 1 : Before start your assembly please remove hardware pack from Top drawer of Vanity Right Side.

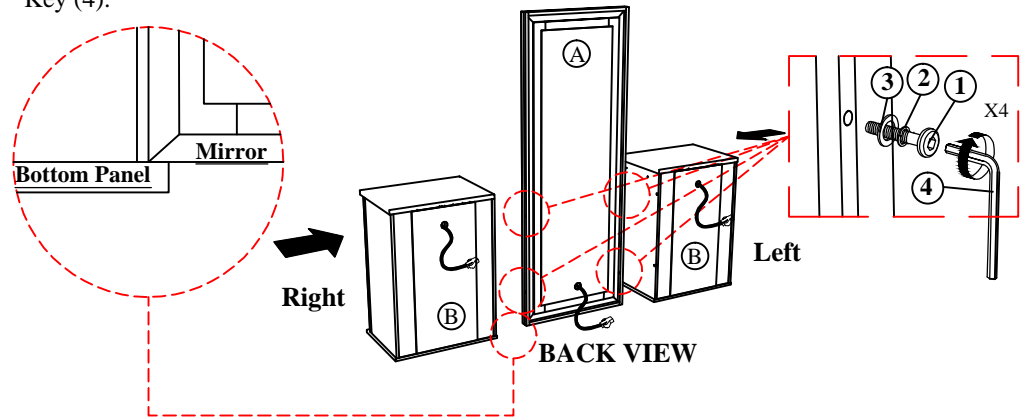



STEP 2 : Attach Mirror (A) to Vanity(L&R)(B) as shown. Insert ,Spring washer (2) , Flat Washer (3) and tighten JCBC Screw (1) using an Allen Key (4).



**(BOX 1)
HARDWARE LIST ENCLOSED INSIDE
VANITY MIRROR**

No	ITEM	Qty
1	JCBC Bolt m6x35mm Blk 	4 pcs
2	Spring Washer 1/4" Blk 	4 pcs
3	Flat Washer 1/4"IDx13mmOD Blk 	4 pcs
4	ALLEN KEY m4x65mm Blk 	1 pc

**(BOX 2)
HARDWARE LIST ENCLOSED INSIDE
VANITY RIGHT**

No	ITEM	Qty
5	612V+12W+1A Adaptor With ETL Certificate 	1 pc
6	Flat Head Chipboard Screw m3x12mm Rbw 	4 pcs
7	Shelf Glass Holder 	4 pcs

STEP 3 : Fixed the Glass holder (7) to the L&R Vanity (B) by following the pre-drilled hole provided . Secure with Csk Screw (6) and tighten them with Screw Driver(NOT PROVIDED).

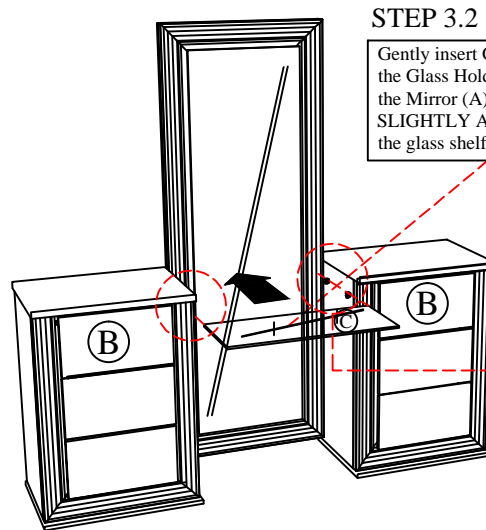

STEP 3.2

Gently insert Glass Shelf (C) inside the Glass Holder (7) and push it to the Mirror (A) frame as shown. SLIGHTLY ADJUST the Vanity if the glass shelf is difficult to push.

STEP 3.1

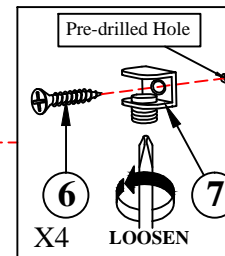

STEP 3.3

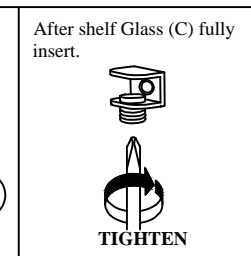

No	ITEM	Qty
8	Led Wire 	1 pc

NOTE : MUST TIGHTEN SCREWS PERIODCALLY OR SCREWS WILL BECOME LOOSE.CHECK TIGHTNESS OF ALL SCREWS EVERY 6-8 WEEKS.

PAGE 1 OF 2

ASSEMBLY INSTRUCTIONS

STEP 4 : Connect the LED wire (8) to the Mirror (A) and Vanity L&R (B) wire cord as Diagram shown. Then Connect LED wire (8) to the Adaptor (5) accordingly.

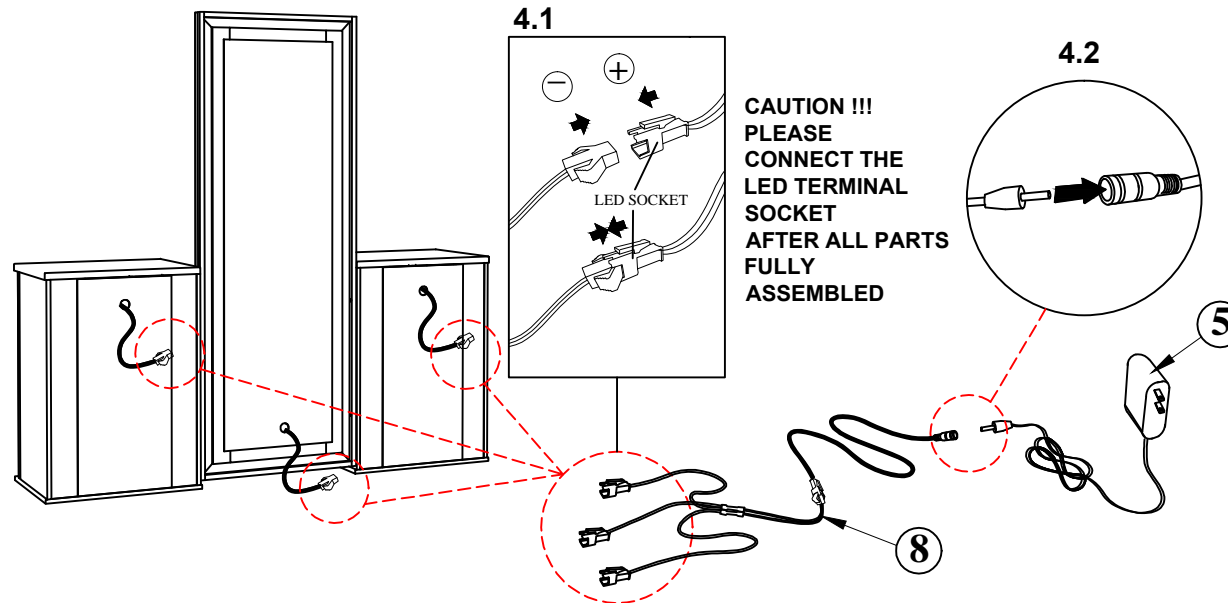

STEP 5 : After Adaptor is Plug in, touch the switch button to activate the LED light as shown.

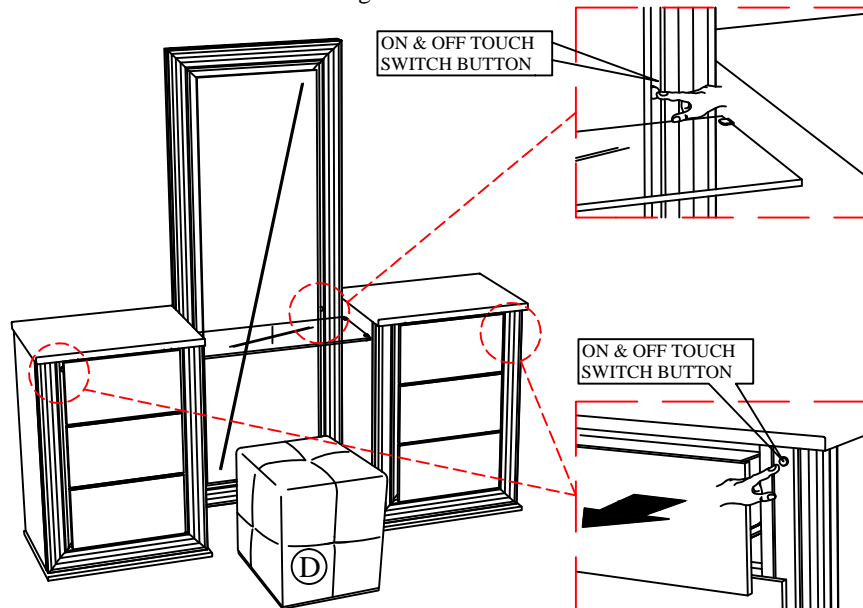

WARNING!!
After Fix Do Not Move.

COMPLETED ASSEMBLY