

Assembly Instructions

Caution:Pls read the AI before you proceed.

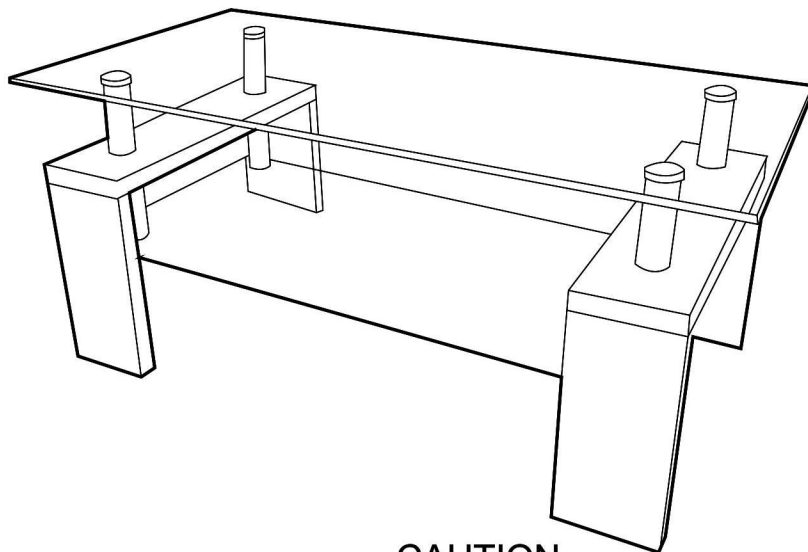

















CONSOLE TABLE



CAUTION:

Pls follow up the AI , when assemble the table leave your child away

Parts List

NO.	Picture	Description	Qty
A		Tempered glass table top	1
B	 8X250mm	Pulling rod	4
C		Tempered glass	1
D		Stainless steel pipe	8
E	 M8X45mm	Gasket	12
F		Allen key	1
G	 M24X5mm	Screw	8
H	 M11X9mm	Eccentric cam lock fasteners	8
I	 M4X20mm	Screw	4
J	 M8X49mm	Box Spanner M10	1
K	 M8X15mm	Nut	4
L		Connection	4
M		Board	4
N		Board	2
O	 M8X19mm	Plastic gasket	4
P	 M8X19mm	Iron gasket	4
Q		Anti-skid pad	8
R		Stickers	8
S		Corner guard	4

Assembly Preparation Before Beginning Assembly

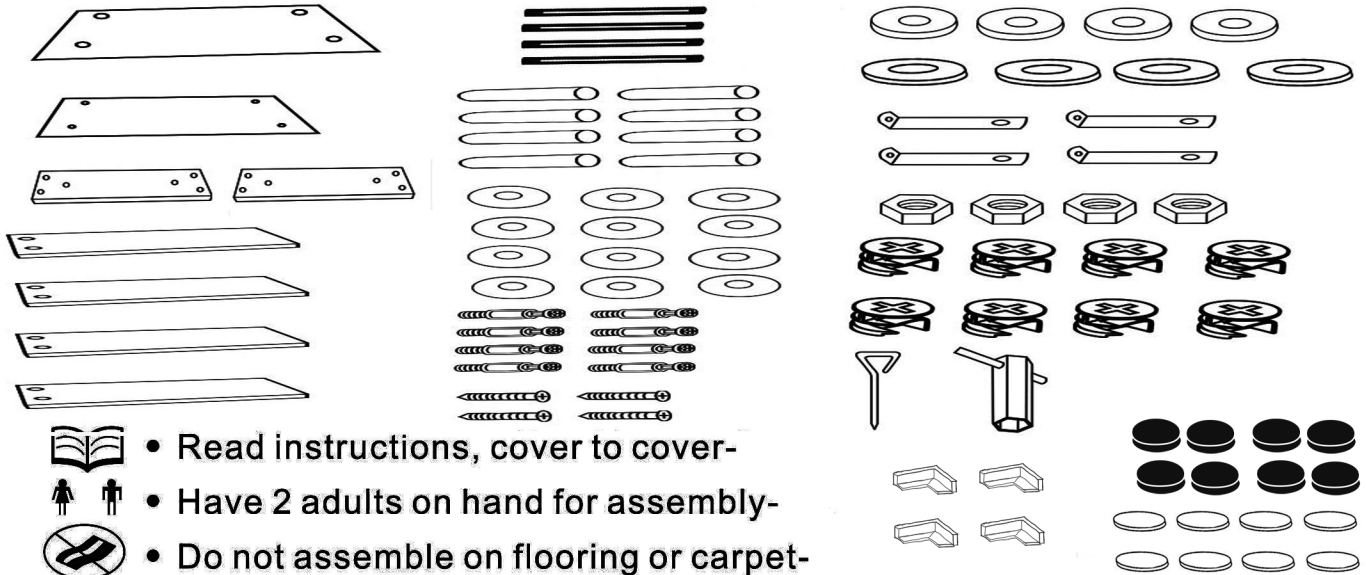

• Read instructions, cover to cover-



• Have 2 adults on hand for assembly-



• Do not assemble on flooring or carpet-



• Assemble on a clean non-marring surface (packing foam)-



• Save all packaging until finished-

Step 1

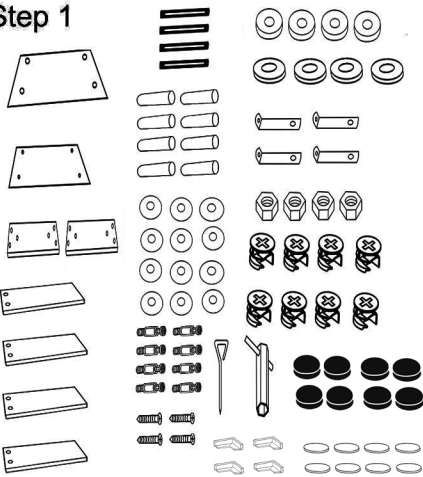

Unpack and place all parts on a clean, soft surface

Step 2

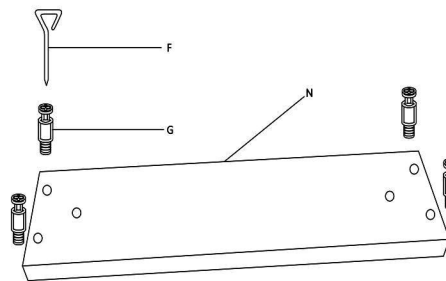

Step 3

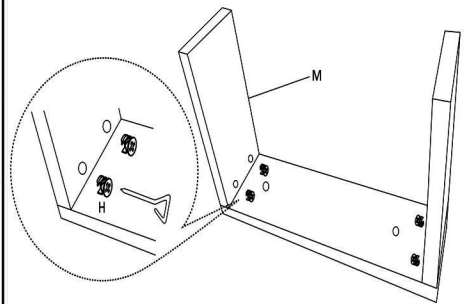

Step 4

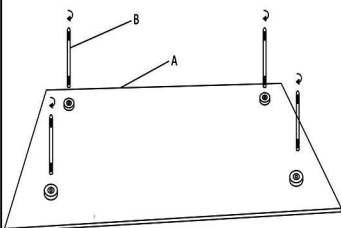

Step 5

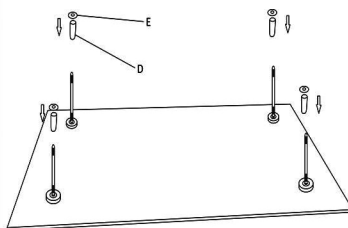

Step 6

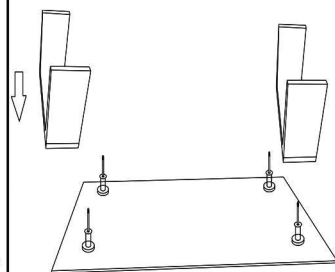

Step 7

