

Product Size: W120 x D60 x H95 cm

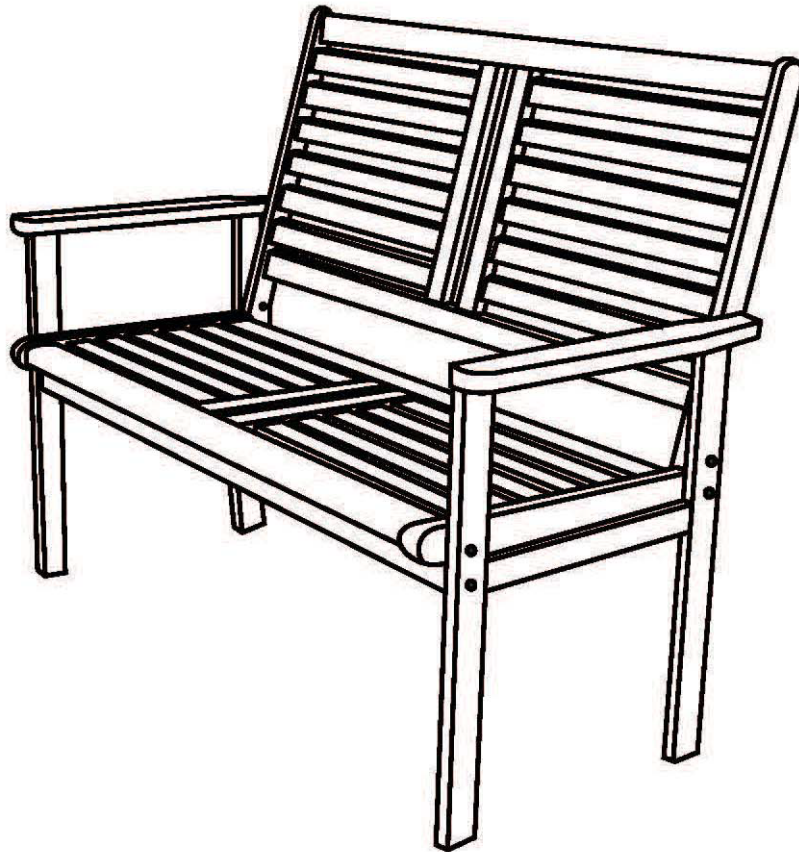

Furniture should be covered/stored whilst not in use
to prolong its longevity.

(It should also be covered in adverse weather)

The intended use of this product is for domestic use only.

Important, please retain for future reference.

Read carefully.

Size: H92 x W119 x D61cm



Warnings

IMPORTANT, RETAIN FOR FUTURE REFERENCE READ CAREFULLY

See enclosed instructions for assembly, safety and care information.

Failure to follow the warnings could result in serious injury.

Handle heavy parts with care.

Ensure that this product is fully assembled as illustrated before use.

This product should only be used on firm, level ground.

Keep small parts out of reach of children.

Do not stand or climb onto this product.

This product is intended for **domestic use** only.

Ensure the product is always placed on level ground.

Furniture can be dangerous if incorrectly used. No liability will be accepted for damage or injury caused by incorrect use of this product.

Take care when opening and folding the furniture. Keep your hands away from moving parts in order to prevent trapping your fingers. Children should not open or close the furniture.

✓ Do's

When you are ready to start, make sure that you have the right tools, plenty of space and a clean, dry area for assembly.

Unwrap all packaging materials and place the components on a suitable surface to prevent scratching your product.

Check all contents are present prior to assembly as per the parts list provided. In the event of problems or missing parts, please contact the seller.

Furniture should be covered/stored whilst not in use to

Check all screws and bolts are tightened and inspect regularly.

During severe weather conditions, including high winds, rain, hail, thunderstorms, extreme heat and cold temperatures, the product should be stored inside in a cool, dry place.

To best preserve this product, please use a protective cover when your furniture is not in use. We would also recommend using a gazebo or parasol over your furniture during the summer period and prolonged sunny spells. This will help prevent harmful UV rays from damaging and discolouring the material.

Timber is a natural product and contains coloured resins which may initially bleed out of the timber when its gets wet. Therefore we recommend that care is taken to protect patios and decking from possible staining where the product comes into contact with the ground. The furniture will stabilise in its environment after the first few times it gets wet.

Wood is a natural material whose appearance will deteriorate when left outside. A surface coating is vital in protect-ing it from premature darkening, or splitting, when exposed to the weather. The finish should be regularly maintained to ensure that the wood is protected from moisture and the furniture continues to look at its best.

This product has been treated with furniture oil during manufacture and the wood requires further treatment before being left out side. When applying furniture oil particular care should be given to the end grain and any joints or crevices, please note that is the products needs to be put together the first coat should be applied to all wood surfaces before assembly.

Should you choose not to treat your furniture, then it will turn a greyish colour and develop cracks. Light sanding can restore the original colour after which furniture oil can be regularly applied in accordance with the instructions above.

A liberal coating of furniture oil should be given to the furniture before it is laid up, and again when it is removed from storage.

Clean your product with a sponge and warm soapy water then wipe with a clean, dry cloth.

Ensure that the product is clean and dry before storage.

Where instructions as to the; storage, commissioning, installation, use and maintenance of the goods or (if there is none) good trade practice are not followed and a defect arises this will void the 12 month manufacturer's guarantee on the product.

✗ Don'ts

Do not use scourers, abrasives, washing powders, chemical cleaners or any other substances containing abrasives since these substances can damage the product.

To preserve the product do not place greasy / oily items directly onto the wooden surface.

Do not place very hot or very cold items on the wooden surface unless adequately thick place-mats are used to prevent such items from coming into contact with the wood.

Do not strike the product with hard or pointed items.

Do not sit or lean on the arms of this product.

Do not use power tools to construct this product.

Do not tighten screws until fully assembled.

Do not overtighten screws or bolts.

Do not use this product if parts are missing, damaged or worn.

Do not stand or climb onto the product and do not use it as a ladder, as this could lead to it unbalancing and overturning.

Never tilt the product during use.

Never drag furniture when moving it, always lift it.

This item is intended for max use 120 kgs, do not exceed this weight

Number of people required to assemble

Two People



Time to assemble



20 minutes

Tools required





Tips: .

It is best not to fully tighten the nuts and bolts until they are all correctly located. Only carefully tighten them when you are satisfied with the alignment of all components.

Be careful not to overtighten.

Assembly Instructions

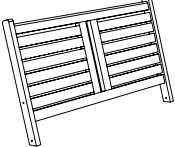
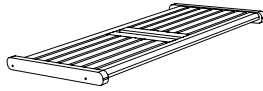
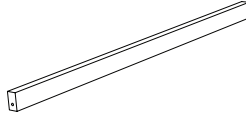
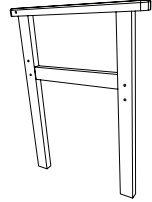
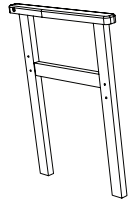
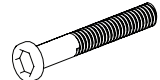
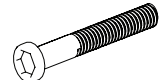
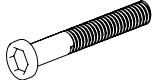
Components, fixtures & fittings (not actual size)

Parts List					
Part No.	Diagram	Qty.	Part No.	Diagram	Qty.
BR	 Backrest	1 PC	S	 Seat	1 PC
CB	 Connecting Bar	1 PC	LL	 Left Leg	1 PC
RL	 Right Leg	1 PC	A	 M6 x 45mm Bolt	6 PCS
B	 M6 x 55mm Bolt	2 PCS	C	 M6 x 60mm Bolt	2 PCS
D	 Barrel Nut	2 PCS	E	 Allen Key	1 PC

Please note the diagram is for reference only, it may not fully represent the actual appearance of the parts.

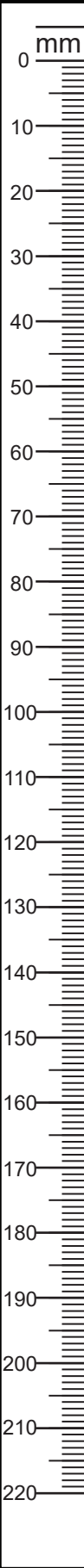

Assembly Instructions

Step by step assembly instructions

Steps

- 1) Fix the Left Leg (LL) and Right Leg (RL) to the Seat (SE) using Bolts (A & B) and Barrel Nuts (D).
- 2) Fix the Connecting Bar (CB) onto the Legs (LL & RL) using Bolts (B) and Barrel Nuts (D).
- 3) Fix the Backrest onto the Legs using Bolts (C).
- 4) Tighten all Bolts when after all components are fixed in place.

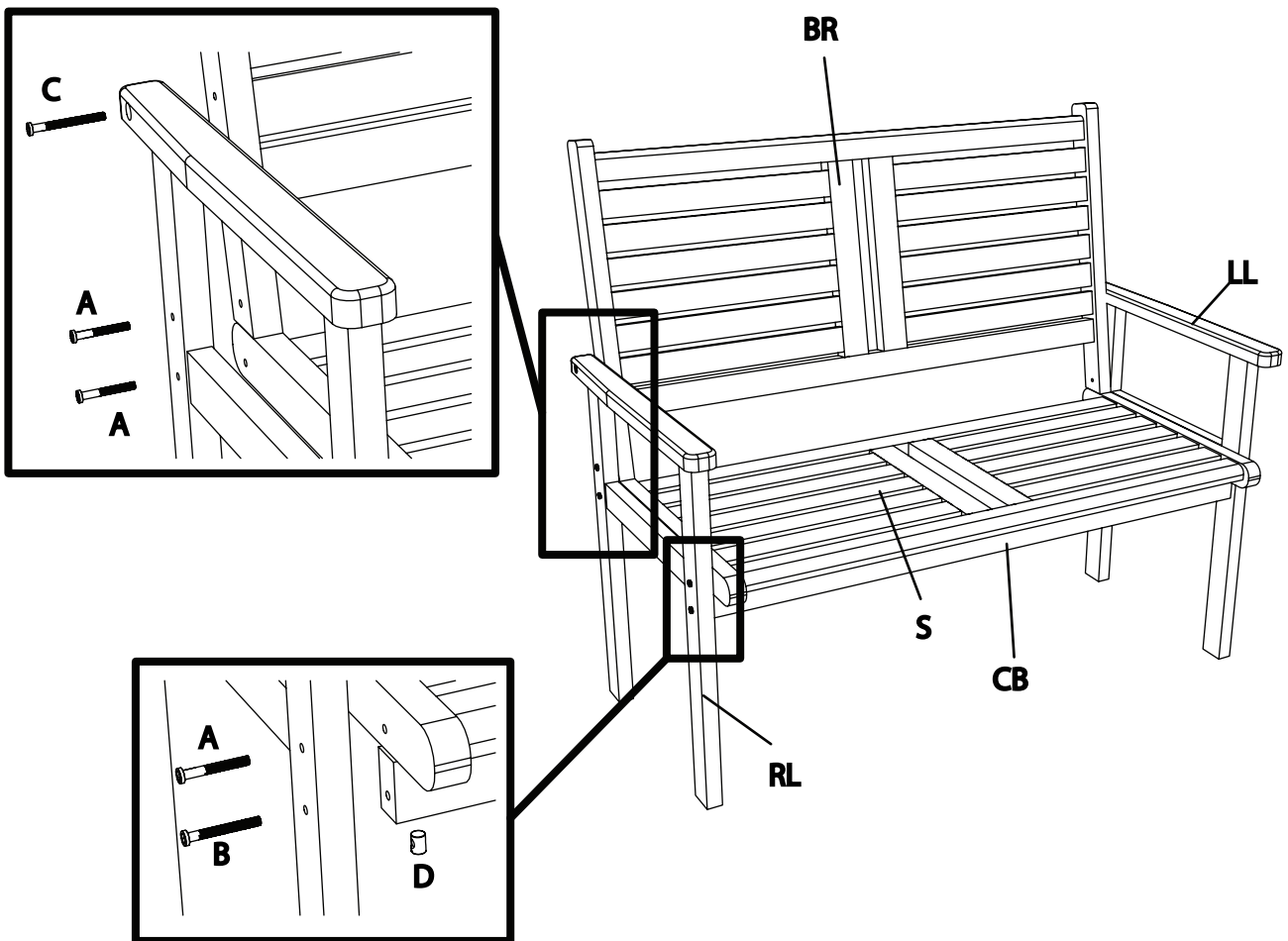

Never tilt the product during use. Ensure the product is always placed firmly on the ground.

PLEASE KEEP THESE INSTRUCTIONS FOR FUTURE REFERENCE