

Assembly instructions for the chair, including tool requirements, time estimate, and person count.

Tools: An icon of an L-shaped Allen key is shown inside a circle. To its right, a power drill is shown with a diagonal line through it, indicating it is not required.

Time: A clock icon is shown with the text "20'" below it, indicating an estimated assembly time of 20 minutes.

Personnel: A stick figure icon is shown with the number "1" below it, indicating that one person is required for assembly.

Warnings: Two warning triangles (a triangle with an exclamation mark) are present. One is positioned above the tool icons, and the other is positioned above the person icon.

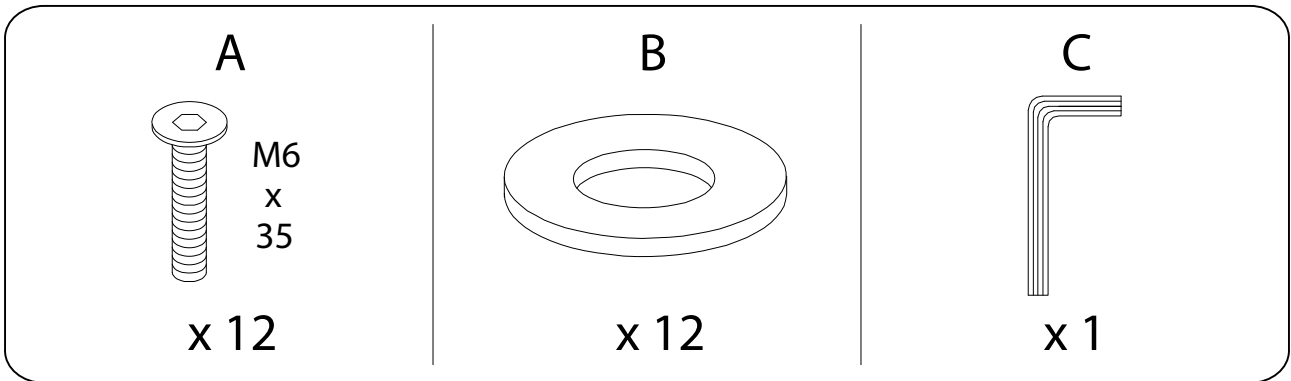
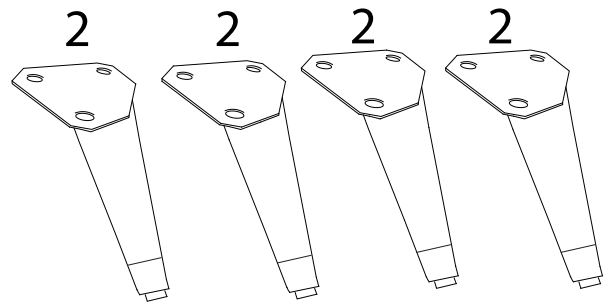
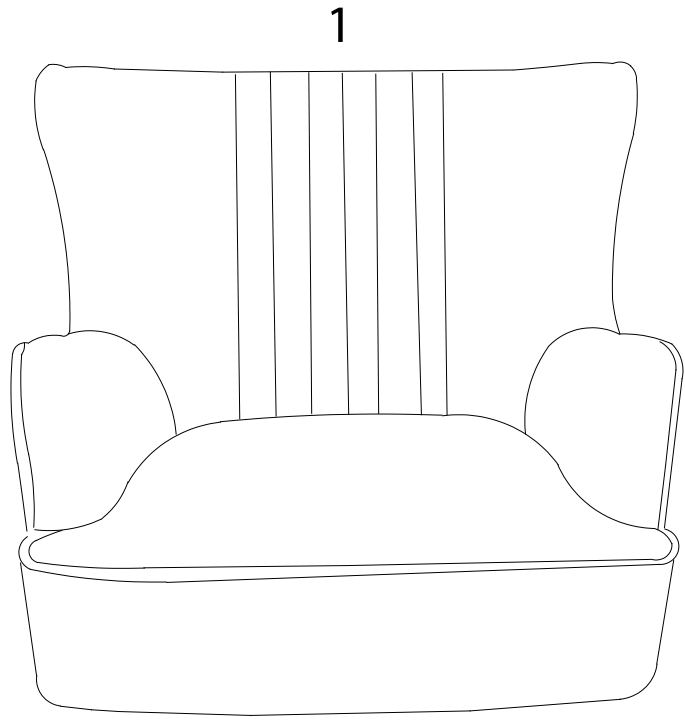
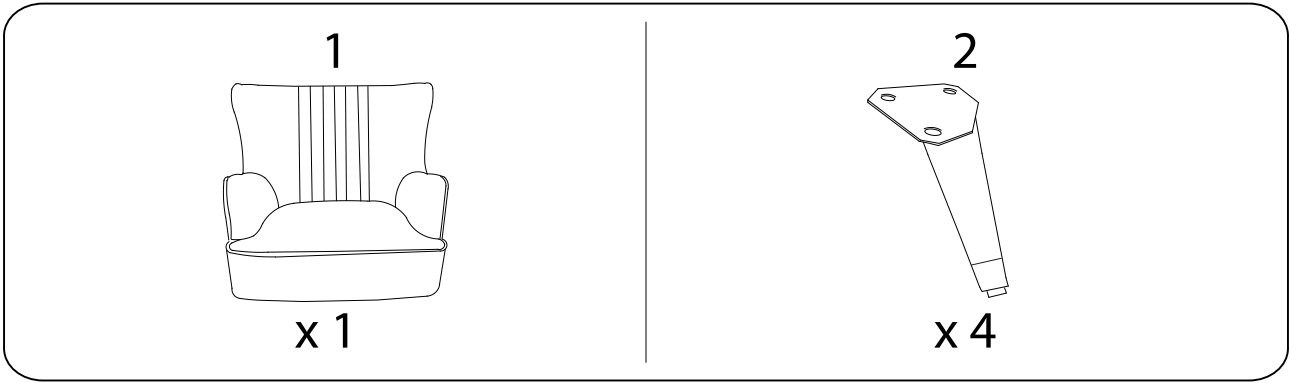

1

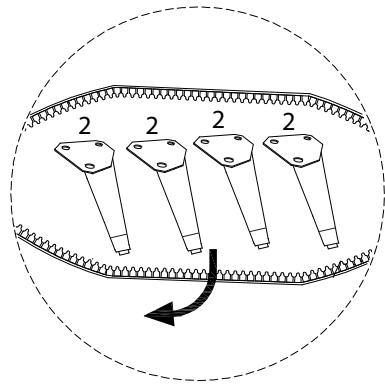
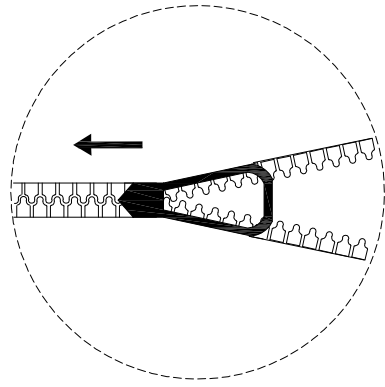
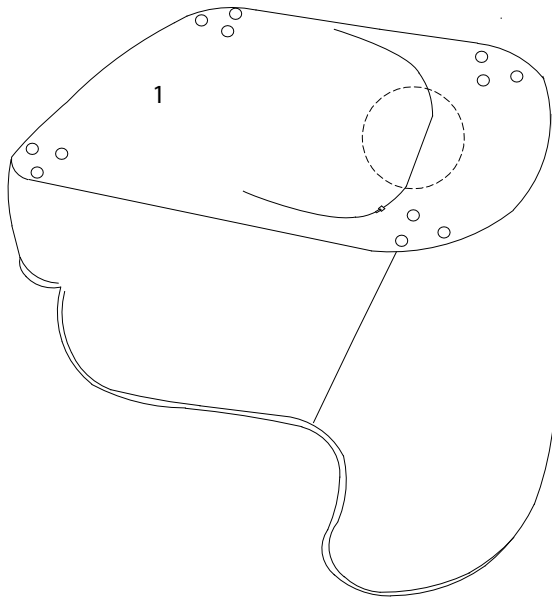

2

