

ASSEMBLY INSTRUCTIONS

SINGLE-BAY HUTCH UNIT

WARNING

Serious or fatal crushing injuries can occur from furniture tip over. To prevent tip over this furniture must be used with the wall attachment device(s) provided. The screw(s) and plug(s) for the wall are not suitable for all wall types. Use screw(s) and plug(s) suitable for your walls. If you are uncertain, seek professional advice. Read and follow each step of the instructions carefully.

This furniture must be installed with the Wall Mount – Anti-Tip Kit to prevent serious or fatal injuries.

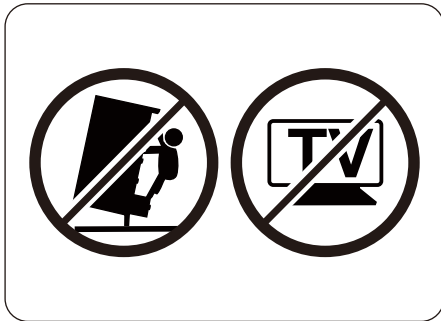

WARNING

Children have died from furniture tipover. To reduce the risk of furniture tipover:

- ALWAYS install anti-tip device provided.
- NEVER put a TV on this product.
- NEVER allow children to stand, climb, or hang on any drawers, doors, or shelves.
- NEVER open more than one drawer at a time.
- Place heaviest items in the lowest drawers.

ASSEMBLY INSTRUCTIONS

SINGLE-BAY HUTCH UNIT

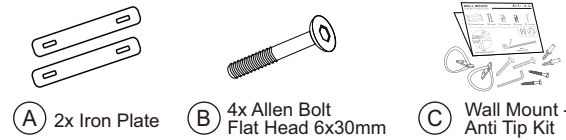

*The L Hex Key is used for both product and wall mount assembly. It can be found in the Wall Mount - Anti Tip Kit (Part E).

Prepare for Installation

- Ensure the product is on a flat, level surface. Features may not function properly on sloped or uneven surfaces.
- Wall Mount must be mounted directly into a concrete wall or stud.

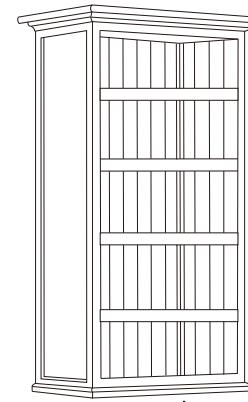
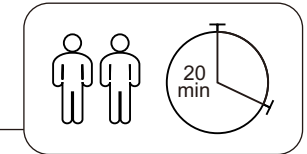

Step 1

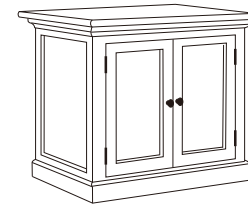

Step 2

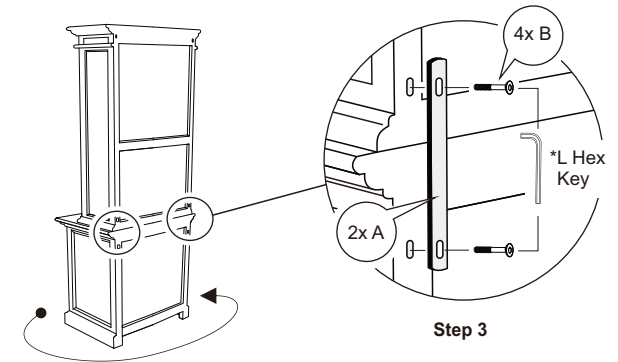

Step 3

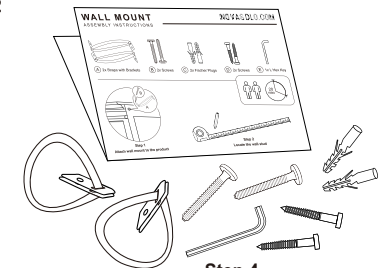

Step 4
Install the Wall Mount per the Wall Mount - Anti-Tip Kit assembly instructions.

WARNING

Always use the proper tools during assembly and follow the steps in order—DO NOT skip any steps. Carefully check all packing materials for assembly hardware. If any parts are missing, contact the retailer from which you purchased the product to obtain replacements. **DO NOT USE SUBSTITUTE PARTS.** When assembling, tighten screws by hand initially. Once all screws are in place, use the provided tool for final tightening. Periodically check that all hardware (bolts, screws, etc.) is secure. **DO NOT STAND ON THE PRODUCT DURING ASSEMBLY.** If the instructions indicate that assembly requires two or more people, **DO NOT ATTEMPT TO ASSEMBLE IT ALONE**, as this poses a risk of injury.