

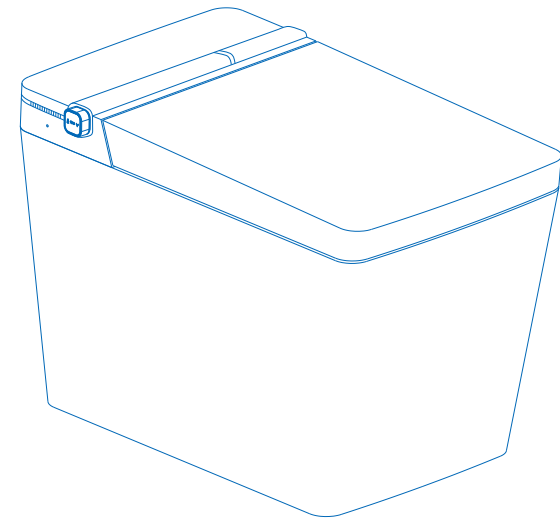

smart toilets WhatsApp



Thank you for being our valuable customers!
Please feel free to get in touch with our after-sale service team if you have any problems, we will get back to you as soon as we can.



Intelligent Toilet Manual

CONTENT

List of Functions	01
List of Configurations	02
Safety	02
Warning	03
Using Notes	07
Names of parts	09
Side Knob operation	09
Digital display	10

Instructions

Check-lists before initial start-up	10
Remote Control	12
Foam liquid installation	14
Operating Note	15

Thanks very much for using our products.

Please read and follow the instructions carefully before using. Save the instructions in proper place and do not loss it.

There would be a little difference from each item.

The shape of item in the manual is for reference only.

The company will not notify you of functional differences due to product upgrades and other reasons.

If there are objections, our company reserves the final interpretation right of the manual.

Routine Maintenance

Daily cleaning	17
Installation	18
Not use in a long time	21
Replacement of battery	21

Freeze in Case

22

Problem & Solution

23

Specification

24

Main Functions		
Rear Cleaning		Rear cleaning by output water from nozzle
Bidet		Bidet cleaning for ladies
Moving Spray		More cleaning effective by moving nozzle
Massage		Massage by rhythmmed water pressure
Water Pressure Massage		The pressure of the cleaning water alternates to achieve the effect of massage.
Children		Press one button to activate full functional auto wash without seated sense.
Nozzle Arm Position		Adjust the nozzle arm forward and backward to get the best washing position to fit the user.
Seat Heating		The cover can be kept in comfortable temp. by mico CPU control
Warm Wind Drying		Automatic drying after cleaning
Soft Close		Dampers cushion the toilet seat and lid noiselessly and slow down closing.
Auto-Sensor		The toilet will stand by while people seat on the inductive area
Smart Flushing		Auto flush will work after the user leaving the seat after sitting down for more than 10 sec, or in one-key mode or pressing the flush button.
Nozzle Self-cleaning		The spray arm and nozzle will be self-cleaned with fresh water.
Energy Saving		Set the Eco mode to save the energy.
Pressure Adjusting		Press the water pressure adjustment button to cyclically set the washing intensity.
Instant Heating		The washing water will be instantly heated to the set temperature.
Power-off Flushing		The flushing can still work while the power is off. (Optional function, subject to each model)
Auto Open		When Auto open is enabled, the lid and seat will automatically open when someone approaches about 30 CM close to the toilet (Optional function, subject to each model).
Temp. Protection		The nozzle washing will be deactivated in case that water is cut or off.
Foot Sensor Flushing		The flushing will work once time while the foot meeting the area of sensor at the bottom of right side (subject to product).
Foot Sensor		The lid will automatically open while the foot meeting the area of sensor at the bottom of right side (subject to product).
UV Sterilization		the UV light will be activated to work for 1 min when the seat cover is close after a seated status for more than 1 min (optional function, subject to model)
Aromatherapy deodorization		Aromatherapy deodorization factor enter into air, encircle and exterminate peculiar smell molecule spontaneously, decompose and disorganize the peculiar smell molecule in the air, reduce the stink.
Ambient lighting		The white ambient light turns on and off simultaneously with the night light.

Functions For Each Type																							
Function Type	Rear	Bidet	Move	Spa	Position adjust	Warm seat	Warm wind	Deodorization	Soft close	Power flush	Power saving	Nozzle clean	Smart flush	Press adjust	Night light	Instant heating	Seat sensor	Auto cover	Auto sensor cover	Foot sensor	Foot sensor shield	UV Sterilization	
B	✓	✓	✓	✓	✓	✓	✓	✓	✓	✓	✓	✓	✓	✓	✓	✓	✓	X	X	✓	X	X	
C	✓	✓	✓	✓	✓	✓	✓	✓	✓	✓	✓	✓	✓	✓	✓	✓	✓	✓	✓	✓	X	X	X
J	✓	✓	✓	✓	✓	✓	✓	✓	✓	✓	✓	✓	✓	✓	✓	✓	✓	✓	✓	✓	X	X	✓

This list consists the full functional features. For the model you choose, there will be optional function, subject to model.

Safety Notes

Please read and follow the instructions carefully before installation and using.

The instructions must be followed while using the product.

⚠ WARNING -Avoid accident of electric shock

1. Do not use the product in a wet environment.
2. Do not drop the remote control into bath tub or sink or any liquid.
3. Do not put water onto product or electric plug.

⚠ WARNING -Avoid accident of getting burnt, electric shock and fire



1. It requires someone to accompany while using the product for people who can not adjust the temperature correctly like children, elder, disabled, paraplegia, etc.. And please set the temp. to lowest level or shut the function down.
2. The product includes functions showed in this manual only. Please do not use extra devices unless we recommend.
3. Do not replace the wire or electric plug yourself while it is broken or dropped into water. The correct way is to call the professional maintenance staff to handle it or send it to a maintenance center.
4. Please ensure the wire would not be burnt.
5. Please do not use the product if you take sleeping pills or are over drinking , or feel drowsiness.
6. Please do not put anything into the hole or water tube.
7. Please do not use the product outdoors.
8. Please do not allow children play the product as toy.
9. Please use the new fittings and hose we supply. The old fittings and hose can not be reused.

Please Keep The Manual in place



Safety Notes

Please do read and follow the instructions carefully before using. They are about safety of person.

Symbols and meanings

 Warning	Ignoring this tag may cause serious injury or death.
 Caution	Ignoring this tag may cause injury or property loss.

Symbols and meanings

	Dismantling is forbidden.
	Must follow.

Warning



No splash

It is forbidden to drop any water and detergent on the product or the electric plug.

- May cause fire or electric shock.
- May cause breakage or leaking.

The smart toilet is an electric product. Please avoid splash and use it in a wet environment. Maintain air circulation when the product is used in bathroom.

- May cause fire or electric shock.

Set the electric socket as below

- May cause fire or electric shock if not follow the instructions.
- a. Please use a high-sensitivity and fast leakage switch for the circuit of the electric socket. Or to use insulated transformer (>1.5KVA, <3.0KVA).
- b. The electric socket should be installed 0.3m at least up to ground and away from the bath tub.

Must install the ground wire

- May cause electric shock without ground wire.

Attn: The electric resistance should be 4Ω and the diameter of the copper wire should be 1.6mm or above.

Using the product in bathroom

Make sure the power plug has been waterproofed with silica gel.

- May cause fire or electric shock without waterproofing.

Warning



No wet

- 1) The user can't directly spray water on this toilet, can use a damp cloth to clean.
- 2) The plug and socket of this toilet can't directly touch with water, and it supports to be used in a humid environment such as a bathroom.



No dismantle

Dismantle, repair or remould the product are forbidden

- May cause fire or electric shock.

Stop using the product while it has malfunction

- Please pull out the plug and turn off the inlet valve.



Forbidden

Malfunction:

Leakage
Dehiscence
Abnormal sound & smell
Fuming & abnormal heating
Blocking

- Keep using the product while it has malfunction may cause fire or electric shock or leakage.



No wet hand

Do not touch the electric with wet hands.

- May cause electric shock.



Forbidden

Do not damage the electric wire/connected toilet

Do not pull, process, heat, forcefully bend the electric wire connected toilet.

Do not put heavy item onto the electric wire, connected toilet.

- Ignoring the breakage and keep using product would cause fire, electric shock or short circuit.



Forbidden

Do not use the power socket with lots sockets

- Do not remould the wire we supply. That would cause fire or electric shock.



Forbidden

Do not use a unsteady socket

- May cause fire or electric shock.



Forbidden

Do not use water sources other than city water

- May cause dermatitis.



Forbidden

Do not use the AC except 110V

- May cause fire.

Warning



Must follow

PREVENT GETTING BURNT

- Please set the seat temp. to home temp. if seating in a long time.
- Please set the seat temp. to home temp. and set the drying temp. to the lowest level for special people.

Users people who can not adjust the temperature correctly like children, elder, disabled, paraplegia etc..

who take sleeping pills or over drinking or weary or drowsiness

Warning



Do not any fire thing get close to the product

- May cause fire.



Do not block the outlet of warm wind

- May cause fire, electric shock or breakage.
- Pay attention to children or the elder is using the product.



**Do not tackle the product strongly
Do not stand on the product or put heavy items on it**

- May cause breakage or injury.
- May cause leakage.



**The surface can be cleaned with neutral detergent only
Do not use things as below**

- (Bath detergent, domiciliary detergent, petrol, thinner, cleaning powder, nylon brush, etc.)
- May cause breakage or injury.
- May cause leakage.



Do not dismantle the inlet filter while the inlet valve is on

- May cause leakage.



Do not bend the tube

- May cause leakage.

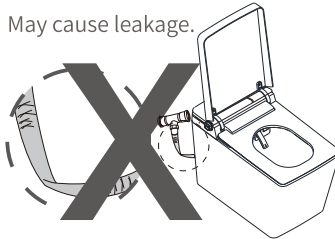

Do not drop into the toilet bowl

- May cause block & leakage.



Turn off the power if the product is not in use for a long time

- Pull out the plug for safety.
- May cause dermatitis by rancid water.



Turn off the inlet valve while it is leaking

Must follow



Prevent the damage from being frozen

- The inlet device and part of product would be damage by freezing and cause leakage.

Must follow



Solidly install the inlet valve

- May cause leakage if not to do.

Please keep proper home temp.



Plug the electric plug well

- May cause fire if the plug is unsteady or not plugged well.
- Pull out the electric plug if the product not in use in a long time



**Please pull out the electric plug while the toilet is blocked
Reuse until the blockage is cleared**

- May cause leakage while running the cleaning function if not pull out the electric plug.



Do not expose the product in direct sunlight

- May cause damage of discoloration, aging and deformation.

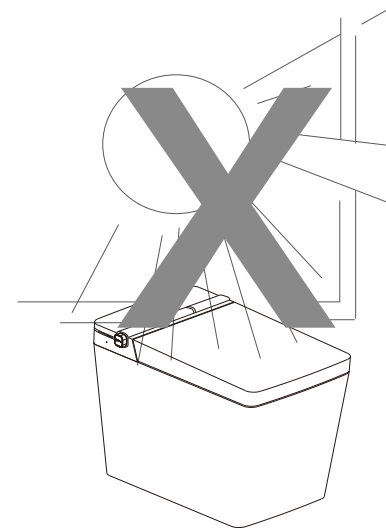

Using Notes

Wrong cleaning manners

Do not wipe the product with dry cloth or toilet paper.

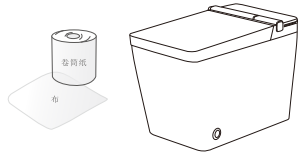

Flushing directly is forbidden

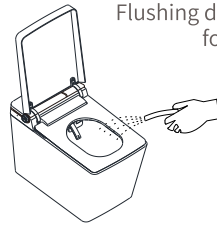

Routine maintenance

Do not urinate on the nozzle or product.

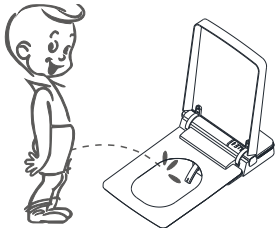

Pull out the electric plug when it is thundering.

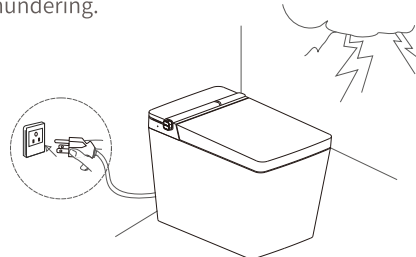

Attention of operation

Do not cover the sensor area, foot sensor, and the signal receiving and sending area of the remote control

Radio or similar products should stay away from the toilet.
• May cause much noise.

Do not lean your back on the cover

- May cause breakage.

Take the children cover away after children using the toilet fan.

- Not doing so may cause some functions can not run.

Using Notes

Please prevent the freezing in winter to avoid damage.

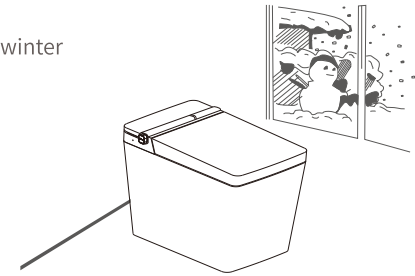

The heating apparatus should stay away from the product.

- Not doing so may cause discoloration or errors.

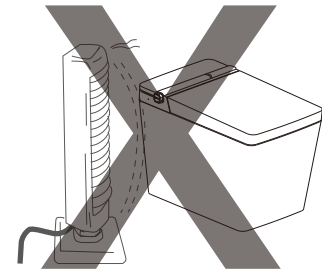

Please open the cover lid and cover seat gently.

- Not doing so may cause breakage or errors.

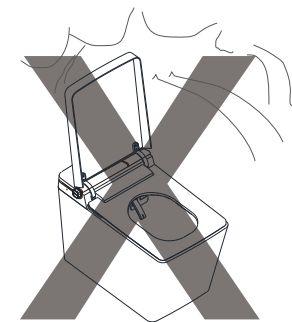

Name of Parts

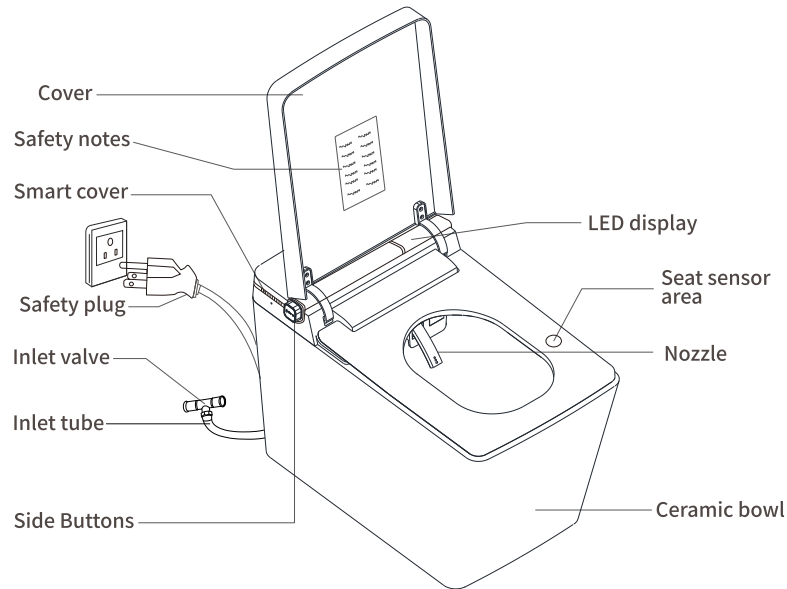

Side Knob Instructions

■ Warm air drying

When someone is seated on the seat ring, briefly press the knob to start drying. It will automatically stop after 3 minutes, or you can briefly press the knob to stop this function. The function will exit when the person leaves the seat ring.

■ Toilet flushing

When not seated, briefly press the knob to flush once. In the event of a power outage, press and hold the knob to flush once.

■ Stop

During use, briefly pressing the knob will stop the current function. In the off state, briefly pressing the knob will turn on the device; in the on state when not seated, pressing and holding the knob will turn off the device.

■ Feminine wash

When someone is seated on the seat ring, rotate the knob counterclockwise to extend the spray rod. The feminine wash outlet will release water for 90 seconds and then stop automatically. You can also briefly press the knob to stop the wash. During operation, rotating the knob counterclockwise again will switch the nozzle to moving wash. The function will exit when the person leaves the seat ring.

■ Rear wash

When someone is seated on the seat ring, rotate the knob clockwise to extend the spray rod. The rear wash outlet will release water for 90 seconds and then stop automatically. You can also briefly press the knob to stop the wash. During operation, rotating the knob clockwise again will switch the nozzle to moving wash. The function will exit when the person leaves the seat ring.



LED Display

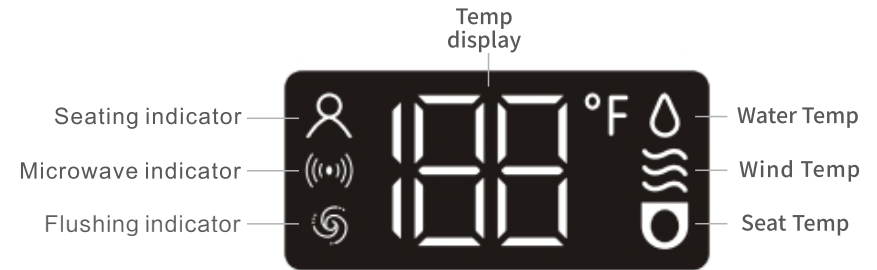

Before Using

Please confirm things as below before using the product at first time.

Plug well

1. Plug in the Listed local voltage.

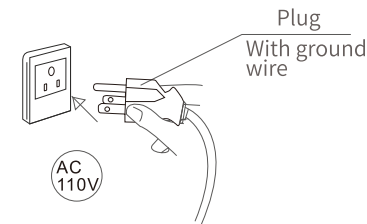

2. Please the inlet valve is opened or not.

Leakage Protected Plug

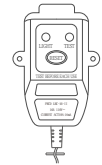

1. Please test once time each month
2. Press the "test" button
3. Confirm that the "pilot light" is off
4. Confirm that the product is out of work
5. Press the "reset" button to boot the the product if every steps as above are OK.

Warning

- Please make sure the ground wire.
- Please contact electrical installation company if your socket is without ground wire.
- The original electric plug is for triple electrode type. (with ground wire)
- There will be changer of the electric shock while the product is out of work.
- Ensure the proper installation of water pipe, tube and valve, otherwise that would cause leakage and loss.



Before Using

Confirm each function

1. The nozzle, water pipe and tube.
2. The light of "saving mode" on LED display should be off while the seat sensor area is covered.
3. Check the rear & bidet washing, defecation assist, deodorization and drying function is well or not.
4. Check the damping is well or not.

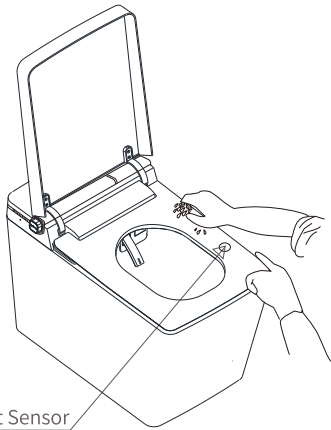

Seat Sensor

Confirm that the seat sensor is on working and the light of "saving mode" or the pilot light is off before checking the function of washing, drying and deodorization.

Caution

1. The washing function is for instant heating type. The function would be out of work if the water inlet is error.
2. Ensure the inlet valve is open and the inlet tube is not bent after the product is booted.

Warning

Only the listed voltage is accepted (AC 110V 60Hz). Please follow the relevant regulations for wiring.



* Will cause fire if ignore this warning *

Remote Control

Friendly reminder: If using for the first time, please pair the remote control as follows.

Remote control pairing method: After the device completes its self-check upon startup, rotate the knob counterclockwise for a long duration (feminine wash) within 30 seconds. The mainboard will emit a long beep indicating entry into remote control pairing mode. At this time, press any button on the remote control. If you hear a beep response from the mainboard, the pairing is successful.

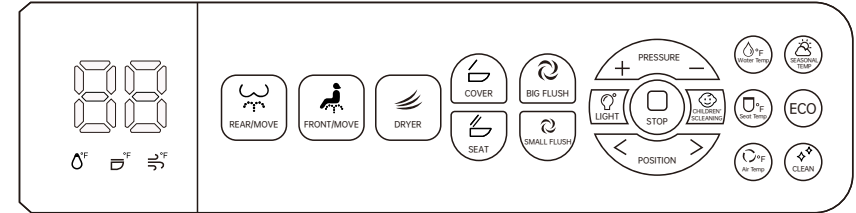

REAR/MOVE

When someone is seated on the seat ring, press this button to extend the spray rod. The rear wash outlet will release water for 90 seconds and then stop automatically. You can also press the [Stop] button to stop the wash. During operation, pressing this button again will switch the nozzle to moving wash. The function will exit when the person leaves the seat ring.

FRONT/MOVE

When someone is seated on the seat ring, press this button to extend the spray rod. The feminine wash outlet will release water for 90 seconds and then stop automatically. You can also press the [Stop] button to stop the wash. During operation, pressing this button again will switch the nozzle to moving wash. The function will exit when the person leaves the seat ring.

SEAT

Press this button to open/close the seat ring. If both the seat cover and seat ring are closed, pressing this button will open them.

BIG FLUSH

Press this button to perform a full flush once.

CHILDREN'S CLEANING

Press this button to enter the child cleaning mode.

+ - PRESSURE

During washing, press this button to adjust the washing intensity.

Water temp

Briefly press this button to adjust the water temperature, cycling through 4 levels (normal, low, medium, high).

SEAT TEMP

Briefly press this button to adjust the seat temperature, cycling through 4 levels (normal, low, medium, high).

Operation

■ ECO

Briefly press this button to turn on/off energy saving. When energy saving is activated, the seat temperature automatically drops to room temperature, with a minimum of 82°F, when not seated. When seated, the seat temperature automatically returns to the set level.

■ DRYER

When someone is seated on the seat ring, press this button to start drying. It will automatically stop after 3 minutes. You can also press the [Stop] button to stop this function. The function will exit when the person leaves the seat ring.

■ SMALL FLUSH

Press this button to perform a economy flush once.

■ POSITION

During washing, press this button to adjust the nozzle's front and rear washing position.

■ Air temp

Briefly press this button to adjust the air temperature, cycling through 4 levels (normal, low, medium, high).

■ CLEN

When not seated, pressing this button will extend the spray rod for 3 minutes, and the self-cleaning outlet will release water. Customers can use this to clean the spray rod. After cleaning, press the [Stop] button, or wait 3 minutes for the spray rod to retract.

■ COVER

Briefly press this button to open/close the seat cover. If both the seat cover and seat ring are open, pressing this button will close them.

■ LIGHT

Briefly press this button to turn on/off the night light and ambient light.

■ STOP

During use, pressing this button will stop the current function. When not seated, pressing and holding this button will turn the device on/off.

■ SEASONAL TEMP

Briefly press this button to activate the four-season temperature sensation. When activated, the seat ring temperature automatically adjusts according to room temperature changes.

Operation

■ UV Sterilization

After the user has been seated for 60 seconds, the system will automatically close the lid upon leaving the seat and activate UV sterilization for 1 minute.

■ Microwave sensor lid opening

When a person enters the sensing area, the seat cover will open automatically.

■ Foot sensor lid/seat opening and closing

When not seated, bringing the foot close to the foot sensor area will open the lid; when the seat cover is open, it will open the seat ring; when both the lid and ring are open, it will close them and perform a economy flush.

Foam liquid installation

1. Take the foam liquid bottle, remove the cap, and peel off the sealing film.
2. Tighten the cap with two silicone tubes onto the neck of the foam liquid bottle.
3. Place the foam liquid bottle on the same plane as the ceramic base, as shown in the figure below.

Note: If the foam at the outlet is sparse, promptly replace the foam liquid to ensure the foam shield function operates normally.

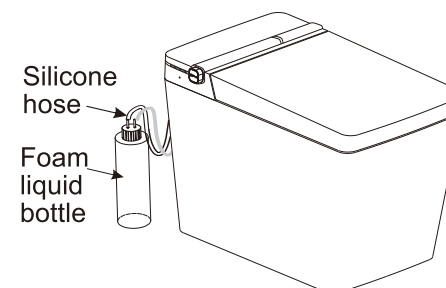

NOTE:

For best performance, add 4 foam tablets to the bottle, fill with water, and wait 20 minutes until the liquid turns blue. You may also purchase ready-to-use Foam Shield locally or on Amazon.

Using Notes

Water Temp.

Capacity

Instant heating device ensure the

Water temp. base on level setting

Level 1: Normal
Level 2: About 93°F
Level 3: About 98°F
Level 4: About 104°F

The effect of heating dependson the water temp.

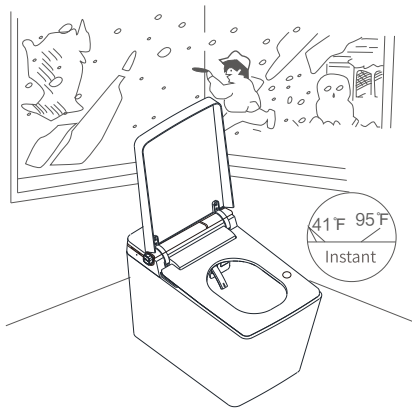

Seat Sensor

The washing functions would not run by operation in error

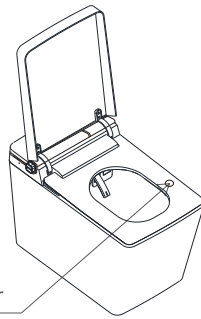

Seat Sensor

The seat sensor would not work if:

※ No people the seat sensor area.

Using Notes

Energy Saving(ECO)

Would save energy as below

- Close the cover after using
 - Do not set the high level for temp. every time
 - Set the suitable temp. on seasons and air temperature
 - Use the energy saving as much as possible
 - The power if the product will not in use for a long time
- ※ Prevent the freezing

Close Cover Softly

The soft-close device would avoid the noise of cover colsing

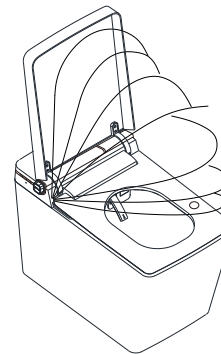

Water flow out ?

That would be normal that some water flow of the nozzle before/after washing or while the water temp. setting is on.

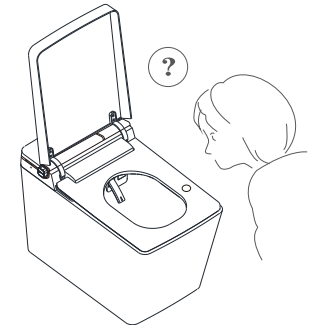

Please close the inlet valve and pull out the plug if the water keep flowing out besides the nozzle as above. And you need to contact the agency.

Maintenance

Warning

Make sure to unplug, pull out the electric plug and confirm the pilot light is off before maintenance.

Maintenance of Smart Toilet

Please use soft cloth with clean water

- Please wipe the product often with wet soft cloth in case of the dirt is too hard to clean out. In addition, the wet soft cloth can avoid the static to adsorb dust and cause the product dirty.

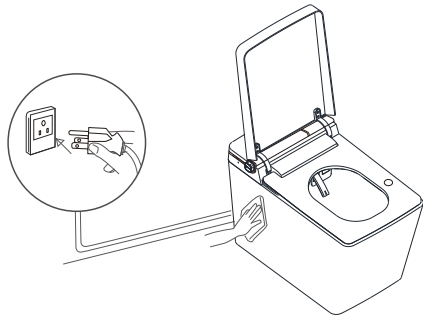

Maintenance of Nozzle

- Please clean the nozzle with soft brush.
- ※ Turn the knob key until the nozzle is out after leaving the cover seat.
 - ※ Do not pull out and bend the nozzle by force.

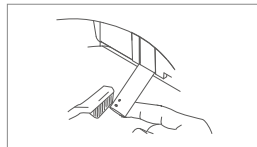

Warning

-  Please clean the dust on the electric plug. Clean the plug with dry cloth after pull it out of socket.
- Must follow ※ Poor insulation may cause fire.

Installation

INSTALLATION DRAWING PLAN & Names of Parts

As shown in Picture No.1, be the major component and construction points
Length Unit : mm

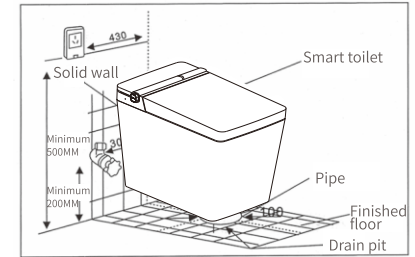

Fig1

Before Installation

Required tools may include Adjustable Spanner, levelling instrument, cross screwdriver, glass cement, slotted screwdriver, measuring tape, knife, etc.

Installation Procedure

1. Please mark the center line of the drain outlet on the ground, then according to the size of the toilet, install the water inlet angle valve on the suitable point of the wall.

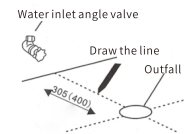

2. Lift the flip lid assembly from the toilet, up from the inside.
Note: Do not pull the lid roughly when lifting the toilet flip lid

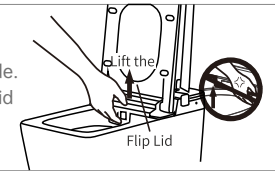

3. Please make sure the wall is aligned with the center line of the drain outlet (there are two pit distance options, 305mm and 400mm). Please mark the location of the center hole (Use the right installed holes based on the real situation). Install the sealing ring at the bottom of the toilet.

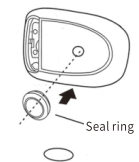

4. Install the flange and floor bolts at the sewage outlet according to the position shown in the right image. Attach the toilet to the flange, making sure the bolts line up with the holes in the toilet.

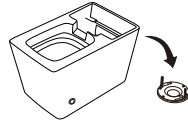

5. Use a wrench to lock the nut and other accessories to the retaining bolts.

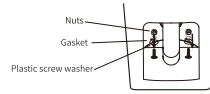

6. To install seat ring and toilet main body: the seat ring positioning hole shall be aligned with the ceramic body positioning column. Then in the seat ring's horizontal state, the hands pressure the back part of the seat ring, so that it can be completely installed.

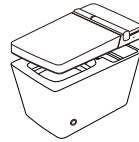

7. Please apply the transparent glue on the joint of the toilet bottom with the floor.

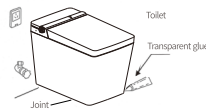

Installation

Tips 1

1. Please make sure the pipes be cleaned, then go to the installation. Because the hose has just been renovated and may left less mud and sand, very easy to damage the toilet and bring something bad towards human' body.
2. Please ask the professional fixed workers to do this job, and make sure carefully every part is correct when done. Kindly please use it after 48 hours when the gule be set.

Tips 2

- After Connecting the water pipe and turn on the angle vale, if the nozzle have the situation of water penetration, please be plugged in, it will automatic reset and stop water penetration. Please turn off the power supplies and the water when you are going to take it apart.
1. During the using and cleaning, if power cut happened, please do not touch the nozzle. When the power on, the function will be back normal by self-test.
 2. Please use the supplied special Water inlet angle valve and the related accessory strictly.

Cleaning the angle valve.

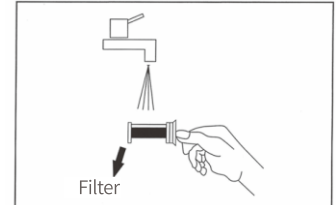
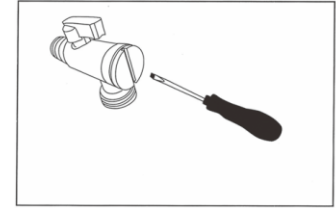

Turn off the angle valve, open the back side by flat screwdriver or coin tool, then remove the filter and cleaning

Warning

1. It is strictly prohibited to disassemble or disassemble privately because the accessory of intelligent toilet was turn up well when you buy it.
2. All content of this operating manual, are based on the latest situation of the product at the time of printing, the company reserves the right to change, No Further notice will be given.

1. Must pull out the plug
2. Must clean up the water in toilet
May cause electric shock if not to do
May cause the fittings damage by water if not to do
3. Do not extrud the wire and tube
May cause electric shock or leakage
4. Handle with care while dismantling the cover to clean
May cause leakage and error
5. Do not put the cover upside down and put on the ground without pulling out the plug
May cause damage of surface and error
6. Before removing the toilet cover, be sure to completely empty the storage liquid in the aromatherapy box with polyester cotton. Otherwise, the storage liquid will leak into the base and a fault will occur.

Do not put the cover upside down.
Do not put the cover on the ground.



Not in use long time

Must clean up the water for situations as below

- The product will be not in use for a long time that would cause blockage by polluted water
- The water will be frozen and leakage cause by falling temperature in uninhabited house

Caution

Must the inlet valve before dismantling any inlet tube

Ensure correct installation of inlet tube

※ May cause leakage easily



Replacing Battery

The pilot light will be getting light or off and the signal can not be transmitted when the battery is almost done.

※ The service life of battery we supply will be very shot cause it is mainly for checking conditions of running in the installation.

- Ensure the position of positive pole and negative pole is correct
- The new and old batteries can not be mixed together
- Please use alkaline battery

Replacing battery of remote control

Open the back cover of remote control and replace two 1.5v AAA alkaline battery

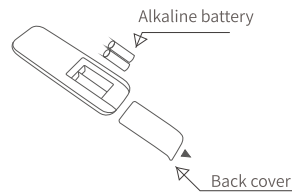

Freezing Damage

The smart toilet will be damage and leakage cause by freezing water from toilet in winter.

Please follow the instructions as below to avoid it.

General Measures

1. Keep power on

2. Set the water temp. and seat temp. to high level and close the cover

3. Turn on the heating in house

- Please follow the ways as below to clean up the water from inlet tube if there is not heating.
 - a. Close the inlet valve
 - b. Run the rear washing until there is no water out after setting to normal level and put a hand on the seat sensor area.

No water out cause freezing

Please use the hot cloth cover on the inlet valve or connecting parts until the water is unfrozen when the water is frozen.

Caution

Do not put the hot water on the tube and do not blow hot air on it.

※ May cause damage of tube

Caution

Must close the inlet valve before dismantling inlet tube.

Ensure correct installation of inlet tube.

※ May cause leakage easily



Error Recognition

There are some simple can be fixed easily.

Please confirm matters below before sending the product to a maintenance center.

Error	Reason	Method
No water out	power of socket is off	check if power failure
	power of product is off	press “start” button to boot the toilet
	no plug in socket	plug in socket well
	leakage of electric	pull out the plug and send the product to maintenance center
	inlet valve is closed	open the inlet valve
	the fillter is dirty	clean the fillter
	inlet tube is blocked	clean up the tube
	out of seat sensor area	adjust the seating position
	the nozzle is blocked	clean the nozzle
	low water pressure	increase water pressure
	water pipe or tube is frozen	Please use the hot cloth cover on the inlet valve or connecting parts until the water is unfrozen
Water not warm	not set the proper water temp. yet	prese water temp. button and set a proper level
	temp. of inlet water is too low	run washing for a while and check after a period of time
Cover not warm	not set the proper seat temp. yet	prese seat temp. button and set a proper level
Smell not well	blocked by dust	clean the part of deodorization

Please contact fora service if the faults still can not be fixed.

Specifications

Part	Spec.	
Rated voltage	AC110V 60Hz	
Power	1130W	
Washing functions	Water flow	Rear 400~660ml/min Bidet 420~650ml/min
	Outlet temp.	Normal / 93°F / 98°F / 104°F (4 levles)
	Pressure	4 levles
	Heating power	1400W
	Safety device	Leakage protector,Water temperature sensor,Thermal fuse
Drying	Wind temp.	Normal / 95°F / 113°F / 131°F (4 levles)
	Heating power	250W
	Safety device	sensitive switch, temp. fuse
Seat heating	Seat temp.	Normal / 93°F / 98°F / 104°F (4 levles)
	Heating power	45W
	Safety device	sensitive switch, temp. fuse
Massage	strong and weak spaced vortex bubbles	
Nozzle position	adjustable for forward and backward	
Inlet water temp.	41°F~95°F	
Inlet pressure	1.5~7.5khf/cm ² (0.1.5 –0.75Mpa)	