

Assembly Instructions

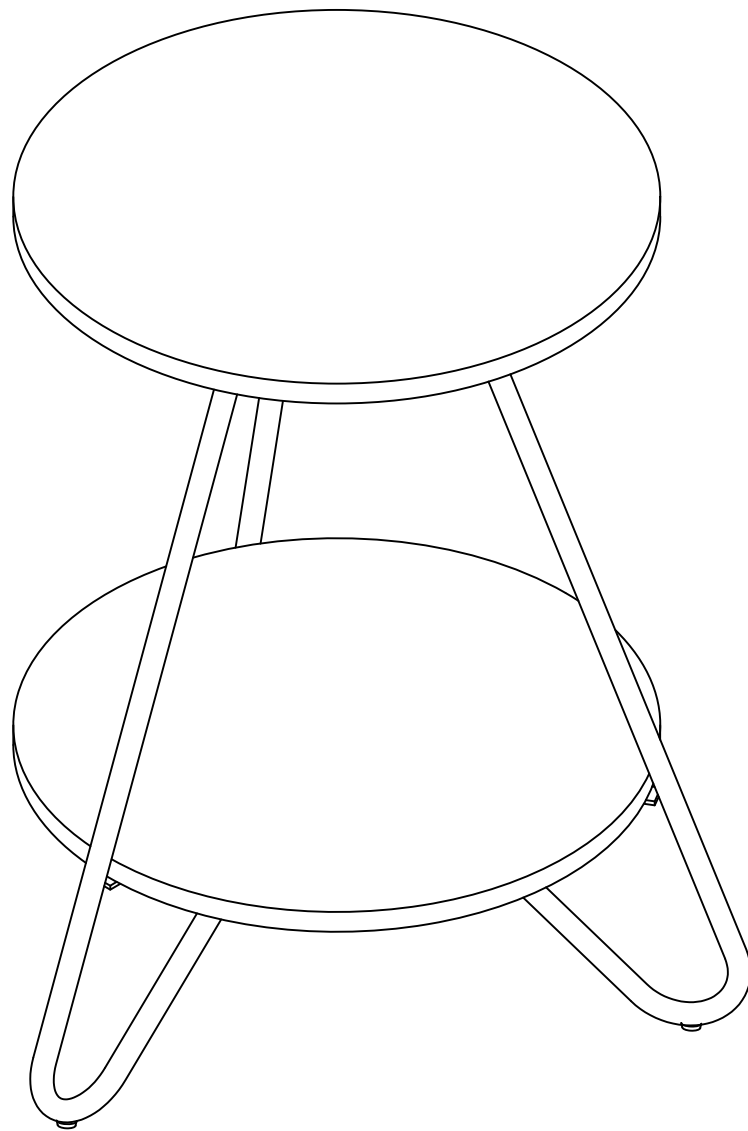

Multifunctional Computer Desk

Call us!

We're here to help!

If you have any issues with this product, please contact our customer service team before returning it.

We want you to be completely satisfied with your purchase! If anything is missing, damaged, incorrect, or not what you expected, don't worry. Please keep the outer packaging and take photos of both the packaging and products, and then reach out to us . We'll take care of everything and send you a free replacement, so you can enjoy your purchase as soon as possible without any hassle.

Assembly Instructions:

1. Carefully read these instructions and keep them for future reference.
 2. Refer to the parts list for guidance and ensure that you have all the pieces before starting the assembly process, if anything is missing, damaged, incorrect, contact us **FIRSTLY BEFORE** assembling.
 3. When assembling, place all parts on a soft, clean, and flat surface, such as a carpet, to prevent any scratches.
 4. To avoid misalignment of the holes, Please don't full tighten the screws until you ensure all parts in place.
-

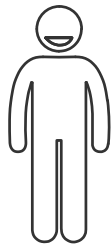

X2

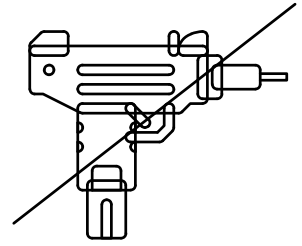
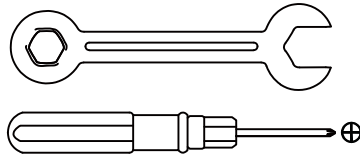

When using the electric screwdriver ,
Reduce the power and torque to avoid damaging the furniture

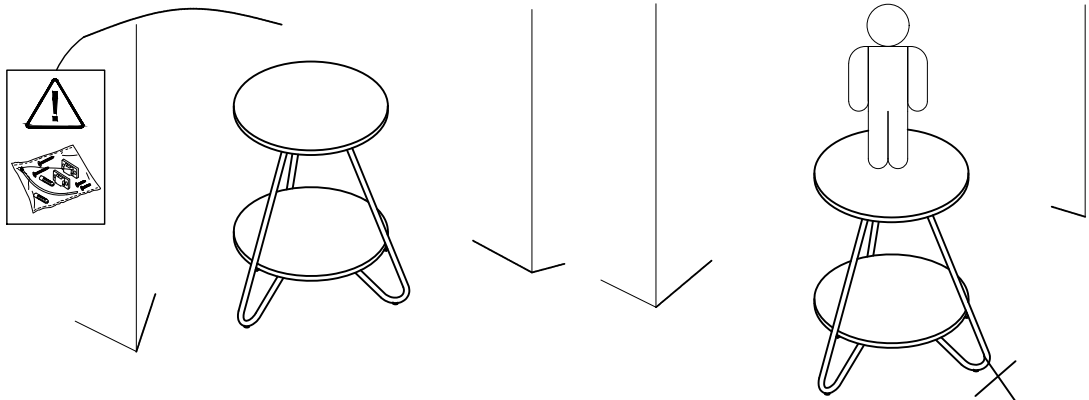
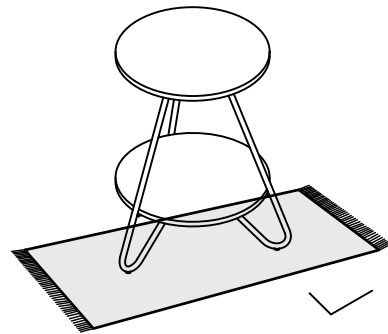
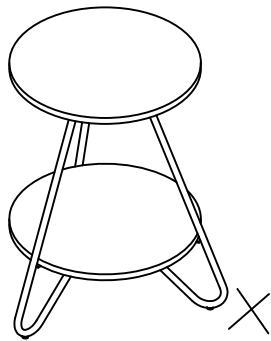
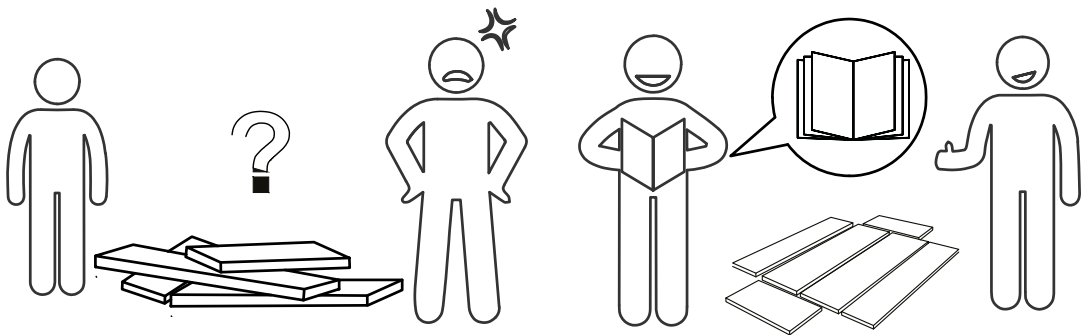

the risk of tip-over.

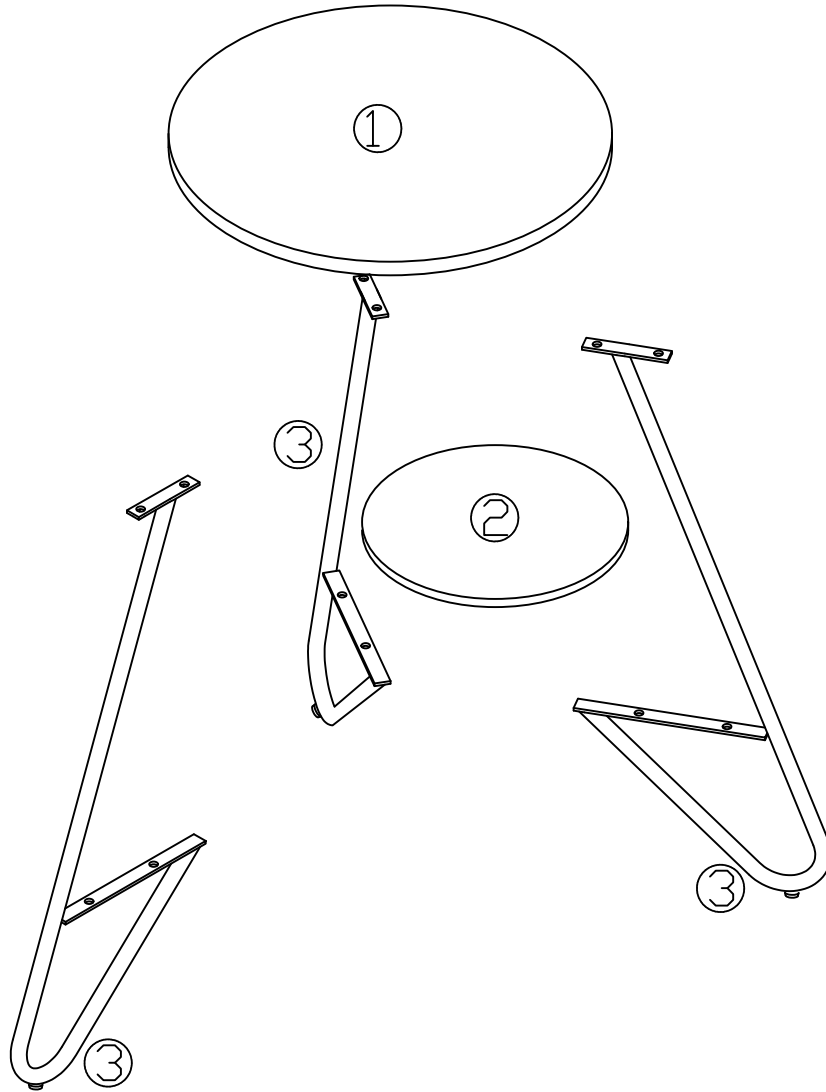

! Caution

Make sure all parts are included. Most board parts are labeled or stamped on the raw edge.

Contact us for free replacement if having damaged or missing parts.

Parts & Hardware List

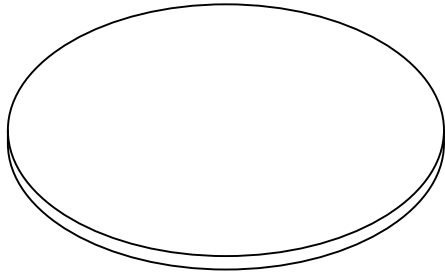

① 1PC

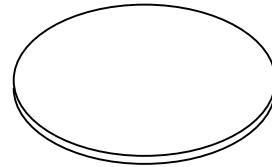

② 1PC

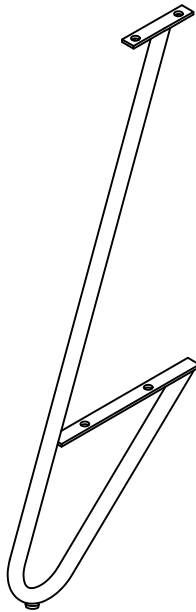

③ 3PCS

Hardware List

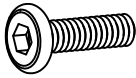
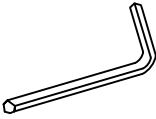
<p>A</p> <p>M6 ×12mm</p>  <p>12PCS</p>	<p>B</p>  <p>1PC</p>
---	---

