

# woodline

shade solutions

## STORM UMBRELLA ASSEMBLY INSTRUCTIONS

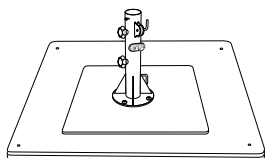
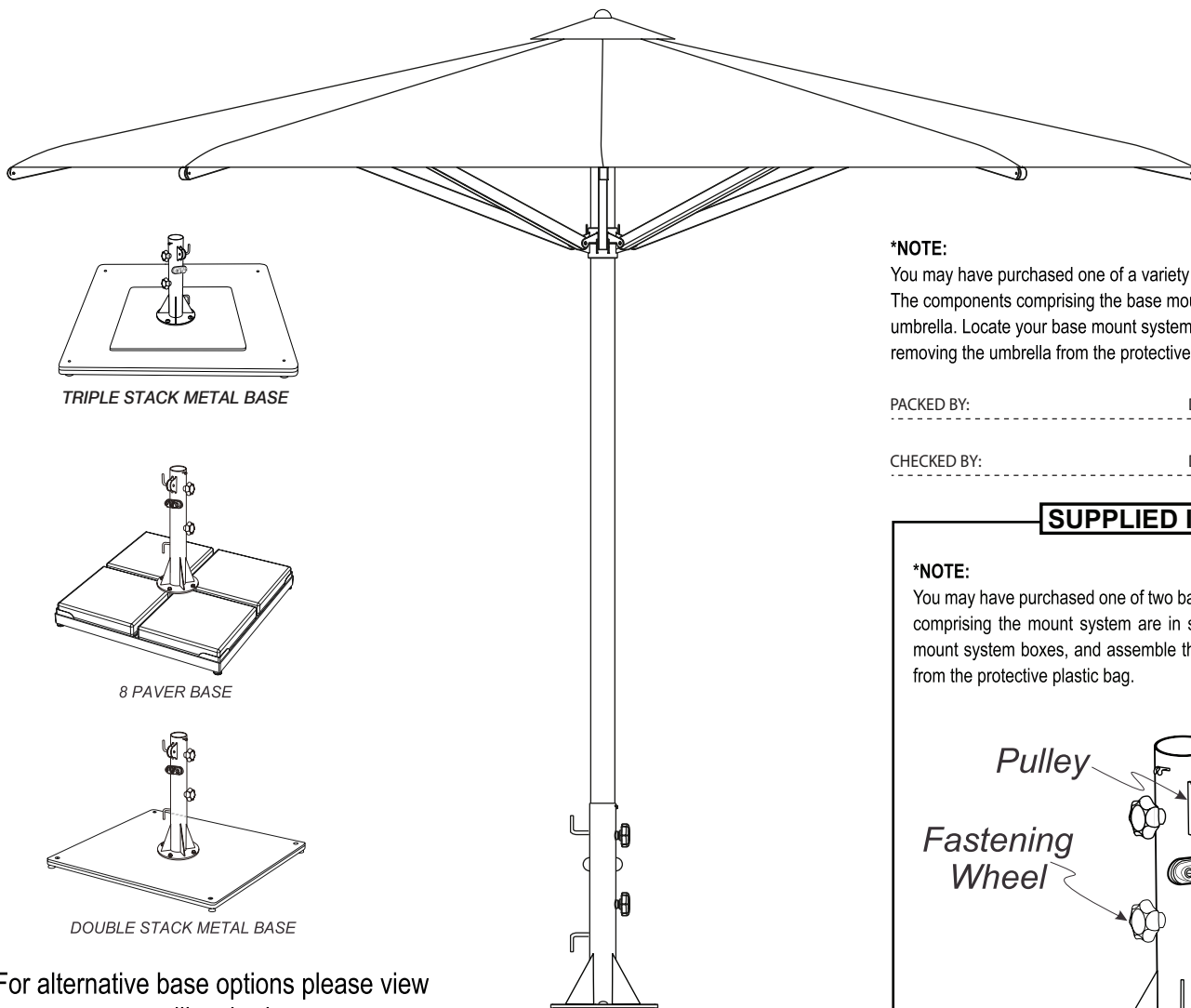

TRIPLE STACK METAL BASE

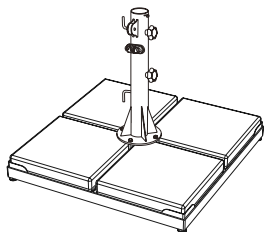

8 PAVER BASE

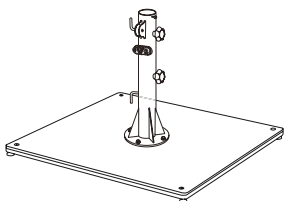

DOUBLE STACK METAL BASE

For alternative base options please view  
[www.woodlineshade.com](http://www.woodlineshade.com)

**\*NOTE:**

You may have purchased one of a variety of bases for mounting the hardwood umbrella. The components comprising the base mount system are in separate boxes from the umbrella. Locate your base mount system boxes, and assemble the base system prior to removing the umbrella from the protective plastic bag.

PACKED BY: \_\_\_\_\_ DATE: \_\_\_\_\_

CHECKED BY: \_\_\_\_\_ DATE: \_\_\_\_\_

**SUPPLIED IN SEPARATE BOX**





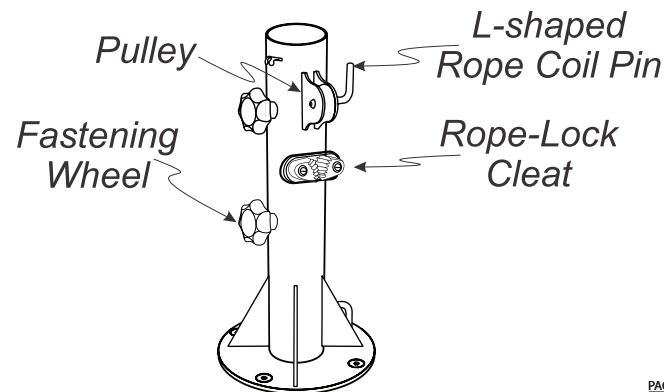

**\*NOTE:**

You may have purchased one of two bases for mounting the umbrella. The components comprising the mount system are in separate boxes from the umbrella. Locate your mount system boxes, and assemble the mount system prior to removing the umbrella from the protective plastic bag.

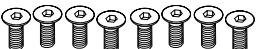

PACKED

**SUPPLIED PARTS**

	<input type="checkbox"/>		<input type="checkbox"/>
UMBRELLA FRAME	PACKED	COVER BAG STICK	PACKED
			
CANVAS UMBRELLA CANOPY			<input type="checkbox"/>
			
PLASTIC PROTECTIVE DISC <i>(attached to top of umbrella frame)</i>			<input type="checkbox"/>
			
FINIAL <i>(attached to top of umbrella frame)</i>			<input type="checkbox"/>
			
8 x M6 X 16 COUNTERSUNK ALLEN SCREWS			<input type="checkbox"/>
			
5mm ALLEN KEY			<input type="checkbox"/>
			
CANVAS COVER BAG			<input type="checkbox"/>

# woodline

## shade solutions

### ASSEMBLY INSTRUCTIONS: STORM CENTER POLE UMBRELLA CORRECT PLACEMENT

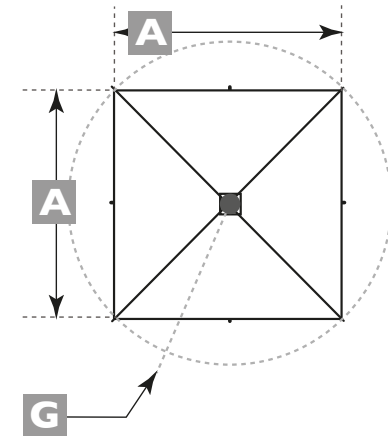
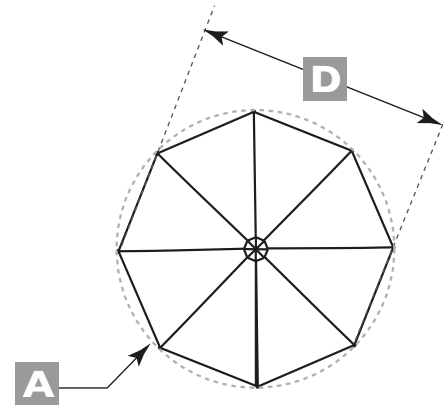
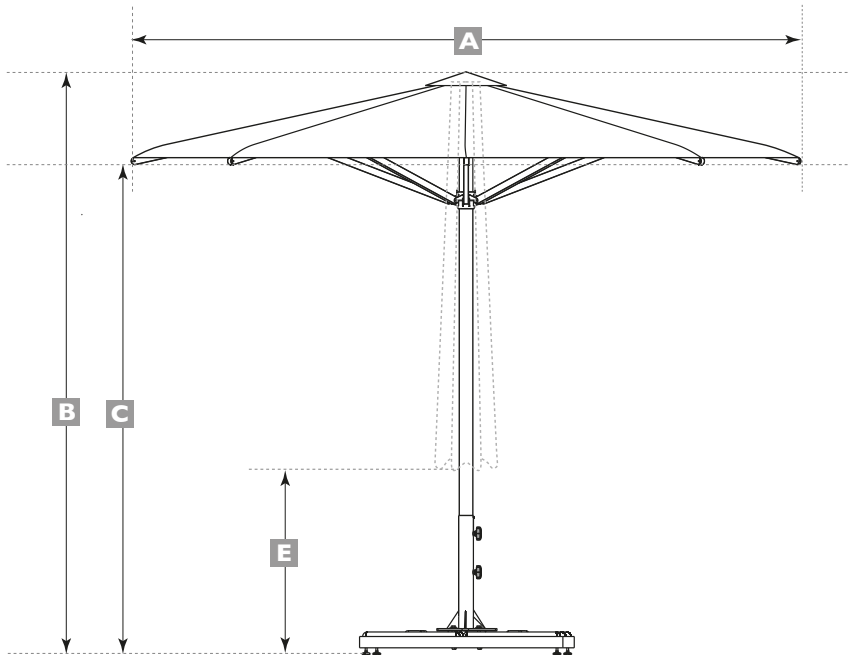

- A** Canopy size:  
Round – size is measured from tip to tip through the center  
Square – size is measured from tip to tip on one side  
Rectangle – size is measured from tip to tip on long side and short side
- B** Height of structure
- C** Head clearance from arm tip
- D** Minimum width
- E** Ground clearance when closed
- G\*** Maximum length of rotation
- Rotation point

model	shape	A (size)	B	C	D	E	G*
ST35RSS	Round 8 arms	11'5" 3.5 m	8'4" 2.53 m	7'5" 2.25 m	10'5" 3.18 m	2'7" .78 m	NA
ST30SSS	Square 8 arms	10' 3.0 m	9'1" 2.78 m	7'4" 2.23 m	NA	1'10" .57 m	13'10" 4.22 m

\* This distance is measured from the pivot point to the farthest distance from this point on the umbrella. The distance defines the radius of the circle created as the umbrella rotates 360 degrees.  
All vertical measurements are taken from the ground level, including paver base.  
All imperial measurements have been converted from metric and are rounded to the nearest inch. For exact dimensions refer to metric measurements.

- A After assembling the base, remove the Storm umbrella from the protective plastic bag and packaging and set it on its side on a table top or similar flat work surface.
- B The first step is to attach the canvas umbrella canopy to the Storm umbrella frame. In the same box as the frame you will find the canvas canopy, plus the clear plastic protective disc and the black nylon screw-in finial which will both already be attached to the top of the frame.
- C Remove the finial from the top of the frame by unscrewing it. Remove the clear plastic disc.
- D Drape the canopy upside-down over one hand, finding the top eyelet hole with your fingers. From the underside, place the finial up and through the top eyelet hole of the canopy with one hand so that the thread protrudes upwards, with your other hand place the clear protective plastic disc over the finial thread with the concave part facing up.
- E While keeping the finial, canopy fabric and plastic disc together, screw the finial into the threaded hole in the top of the aluminum umbrella frame, tighten by hand and then guide the canvas so that it lies draped in position over the frame with the corners positioned by the end of the frame ribs.
- F Carefully raise and then slide the umbrella pole into the mount tube on the base to get it up into the raised position. Securely tighten the fastening wheel/s.
- G Attach the canopy ends to the ribs using the supplied countersunk M6 x 16 countersunk screws and tighten with allen key. Remove the protective string and packaging from around the hub.
- H The Storm comes with a quattro pulley rope system for easy open and closing. Find the end of the rope hanging down from the Storm frame and guide it down through the pulley in the base stand, and attach the rope end plastic stopper to the very end of the rope and make a knot.
- I Open the umbrella by inserting your fingers into the ribs and opening them slightly outwards to allow free movement of the rope and to push the ribs away from the pole.
- J To open the umbrella simply pull down steadily on the rope until the frame is fully opened. Inserting the locking pin is optional when using the rope lock stand.
- K Lock the rope into position by threading it straight down through the rope lock cleat, then wind the excess rope neatly around the supplied L-shaped pins.
- L To close the umbrella pull down on the rope until it releases from the rope lock cleat, then carefully lower the umbrella. Always fold and strap the canopy when the umbrella is not in use, or the umbrella is unattended. Damage can result from abrasion caused by wind if the umbrella is left closed and not properly folded and strapped. See canopy folding instructions for proper folding instructions.

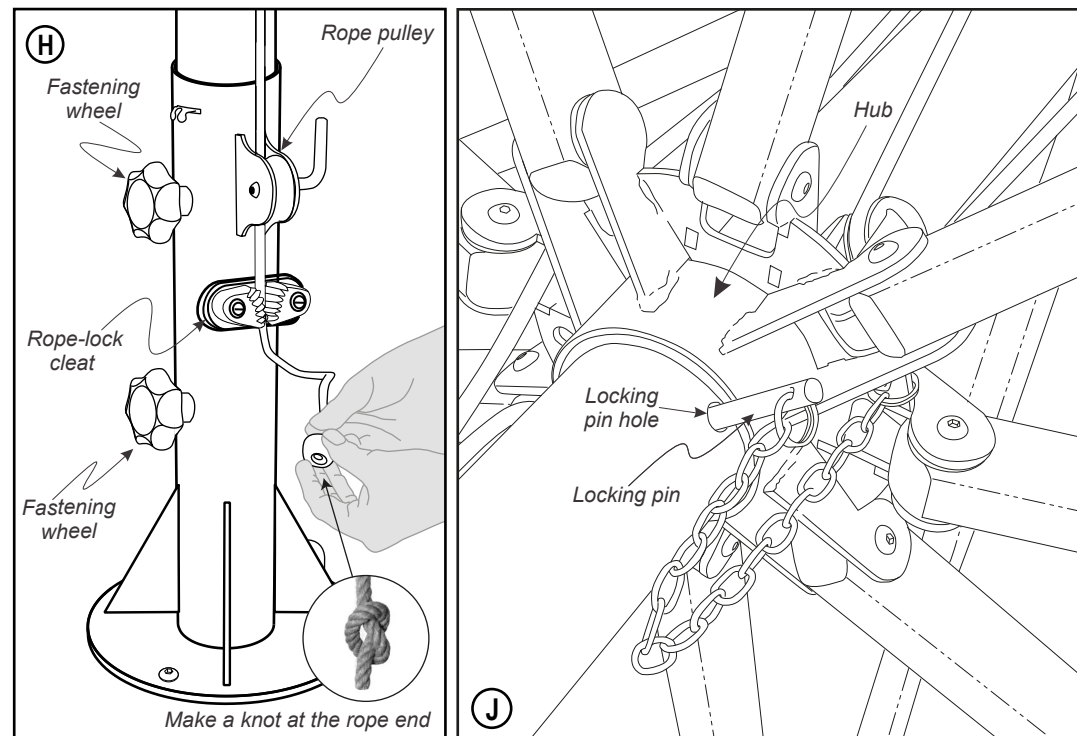
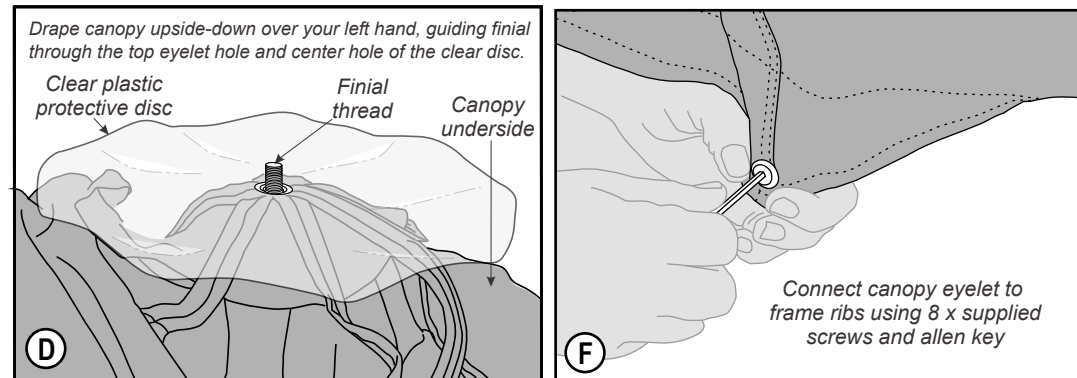
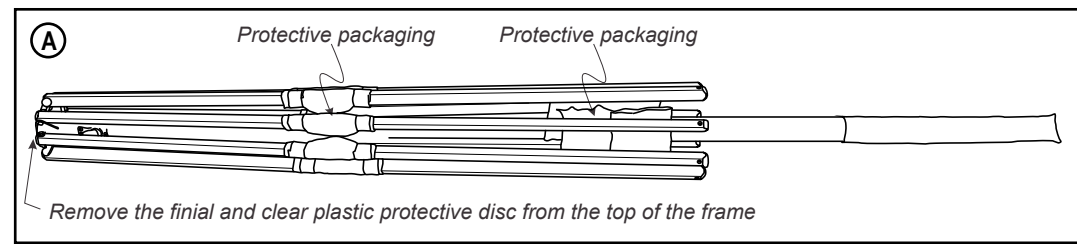

## CANOPY FOLDING INSTRUCTIONS

- 1 In order to avoid the canopy fabric from being jammed between the frame components, it is important to pull the fabric out from the umbrella structure by putting a finger under the edge of the canopy and pulling the fabric outwards. Do this for all the panels and fold the panels over each other like you would with a hand-held umbrella.
- 2 Tie the canopy strap tightly otherwise the canopy can move in wind conditions and get damaged through rubbing.
- 3 Place cover bag over umbrella for extra protection to prolong the life and preserve the color of the canopy.
- 4 Always ensure that the umbrella is in a dry condition before closing umbrella or applying the cover bag.

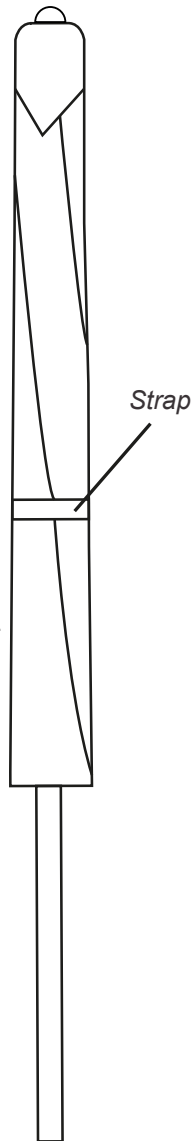

## HOW TO FIT YOUR COVER BAG CORRECTLY

COVER BAG  
STICK POUCH  
FOR STORAGE  
OF COVER BAG  
STICK WHEN  
THE UMBRELLA  
IS CLOSED

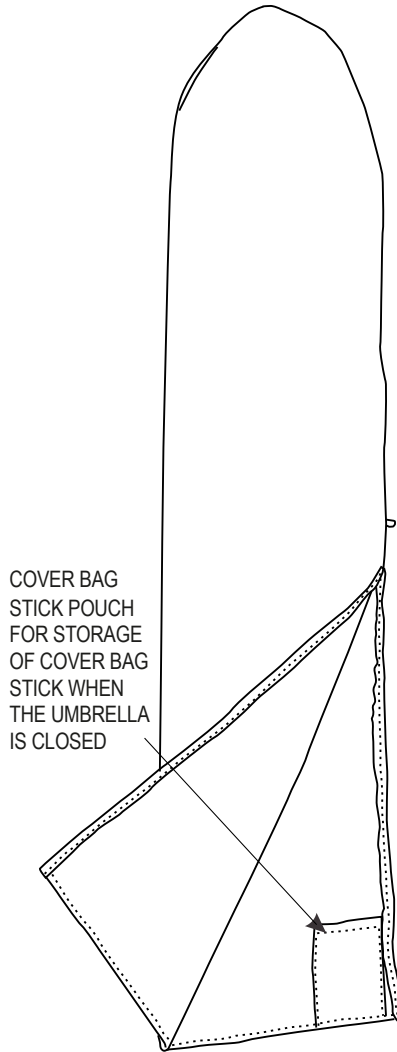

- 1 Lay out the cover bag flat on a table with the zip totally opened.

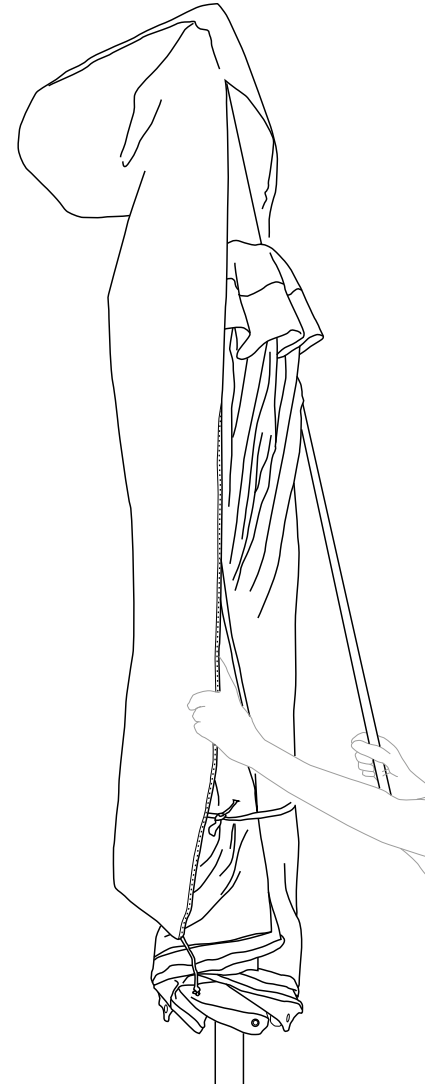

- 2 Insert the supplied cover bag stick inside the bag all the way to the top, lift up the cover bag vertically and place it gently up and over the top of your closed umbrella.

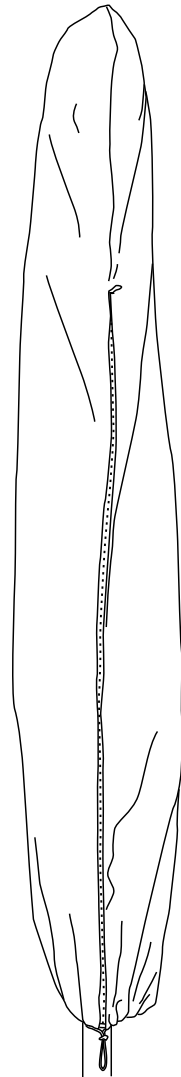

- 3 Lower it into position. Cover bag stick can now be placed in the special pouch within the cover bag for safekeeping. Zip bag closed and tie the drawstring securely.

## CARE AND MAINTENANCE

Every Woodline shade solution is meticulously engineered to maximize not just their form and functions, but also to make sure that they outlast even the harshest conditions. Each item is crafted from the finest marine grade weather-resistant materials, specifically selected for their ability to endure. Though our shade solutions are built to last, the relentless and extreme nature of the outdoors dictates that proper care and maintenance will always extend the lifespan of any item.

### FRAMES

Constructed from the finest quality aluminum, high grade stainless steel and durable and sustainable eucalyptus timber. Our frames have been tested in some of the world's most inhospitable environments and have only ever benefited from the appropriate application of caution and common sense in excessive wind conditions.

We advocate the use of our cover bags to prolong the life of the canopy frames and their covering fabrics. We recommend the closure and safe storage of any collapsible and removable components when the parasol is not in use or when winds are expected to exceed 24.8 mph (40 km/h).

### WOODEN COMPONENTS

We only use sustainable eucalyptus timber hand-picked for its strength, weather-resistance, and replenishment efficiency from the world's finest FSC-accredited plantations and timber mills. Our wooden components are treated with marine yacht varnish to fortify them for outdoor living. We recommend the periodic care of wooden components with a light sanding and reapplication of the varnish coating once a year to maintain the natural beauty of the wood.



### FITTINGS

All fittings, nuts, bolts, pulleys and cleat components are made with high grade stainless steel and weatherproof nylon. Maintaining these fittings and components is imperative to the longevity and the proper operation of the shade system. A simple occasional fresh water rinsing will help keep them working well and looking good.

### BASES

It is essential to pick the right base for your parasol, talk to our sales team to ensure that the parasol you choose has the appropriate base to keep it anchored properly.

### FABRICS

Our canopies and fabric covers are made from the most durable, colorfast, and dirt-repellent fabrics in the world. That said, proper care such as storage when not in use and cleaning from time to time will undoubtedly extend their lifespan.



UV RESISTANT



WATER/STAIN RESISTANT



BREATHABLE



MOLD RESISTANT



EASY CARE



PROTECTS FROM UV

### WIND GUIDELINES

\*The umbrella should always be closed during very windy conditions. As with all umbrellas, common sense wind guidelines prevail: if it is too windy to enjoy sitting outside under the umbrella, the umbrella structure should be lowered, folded and secured with the strap.

\*When unattended, the umbrella structure should always be left in the closed position with the canopy folded properly, securely strapped with the cover bag placed over the umbrella.

\*The umbrella structure must always be lowered, properly folded and strapped during heavy rains, thunderstorms, hail or any other severe weather conditions. Always anticipate to give time to properly fold the canopy, as during severe conditions if not folded properly, the fabric may become damaged.

\*If very extreme weather conditions are anticipated, the umbrella structure should first be lowered, folded properly, strapped and placed in the cover bag. Then the entire umbrella structure should be removed from the base and stored in a clean, dry location.

[www.woodlineshade.com](http://www.woodlineshade.com) | +1 848 266 0800