

# Assembly Instructions

**CAUTION:** You must read this before you proceed.

Please look in the Table Top for hardware packs.

## **TABLE**

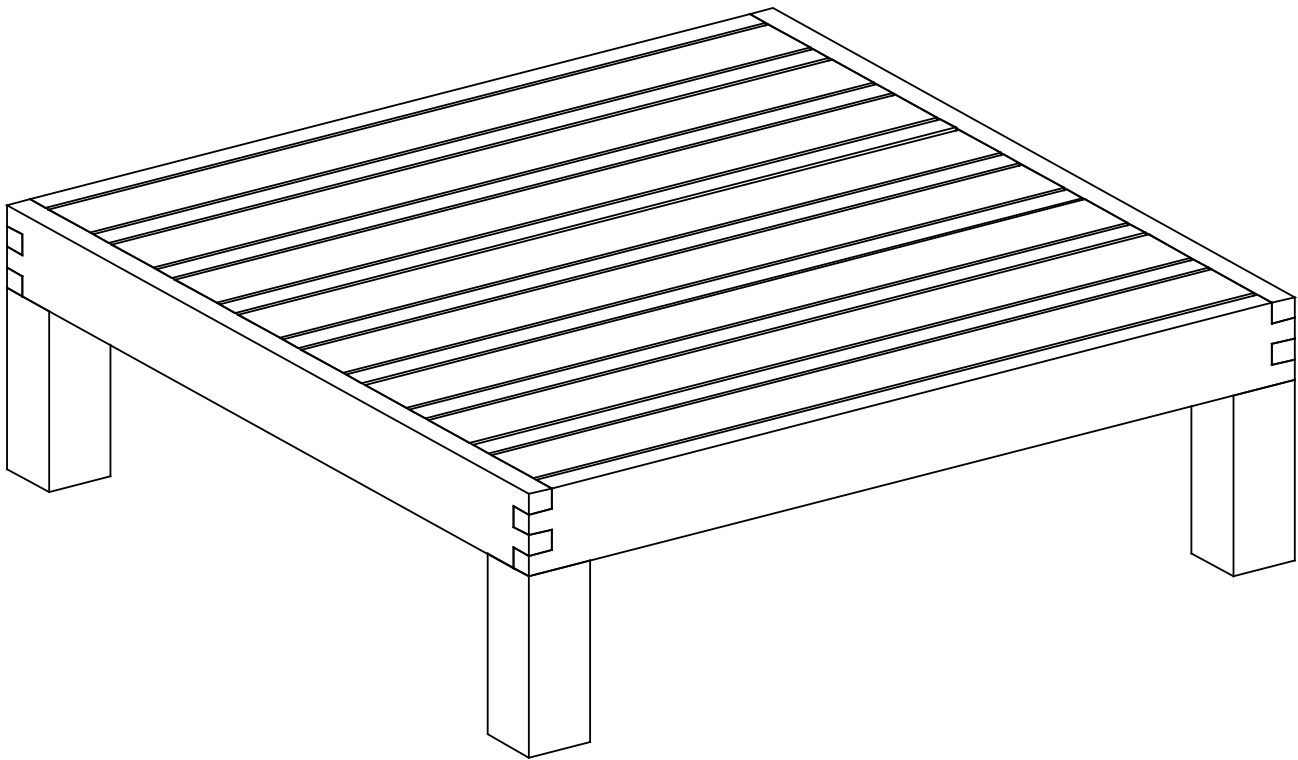

**CAUTION :** This Table is NOT a TOY.



Keep your child / children at bay in the process of assembly.

For turning the Table and to prevent damage to the Table, 02 persons may be needed to execute this action.

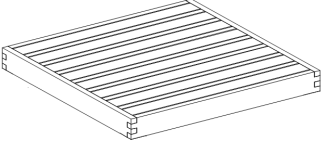
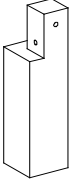
## Parts List

No.	Picture	Description	Qty
A		Table Top	1
B		Legs	4

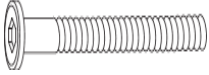
## Hardware

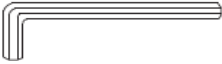
No.	Picture	Description	Qty
①		Bolt (M6 x 55mm)	9
②		Flat Washer (M6xD1.5mm)	9
③		Allen Key	1

## Assembly Preparation

### Before Beginning Assembly:

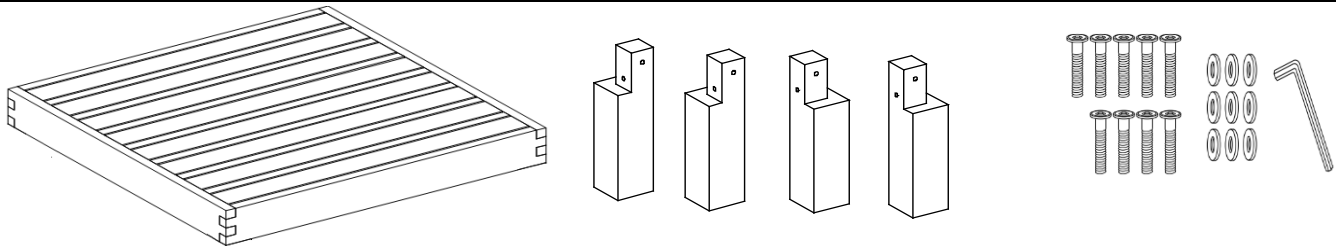

Read instructions, cover to cover.



Have 2 adults on hand for assembly.



Do not assemble on flooring or carpet.



Assemble on a clean non-marring surface (packing foam).



Save all packaging until finished.

## Assembly Steps

### OVERVIEW

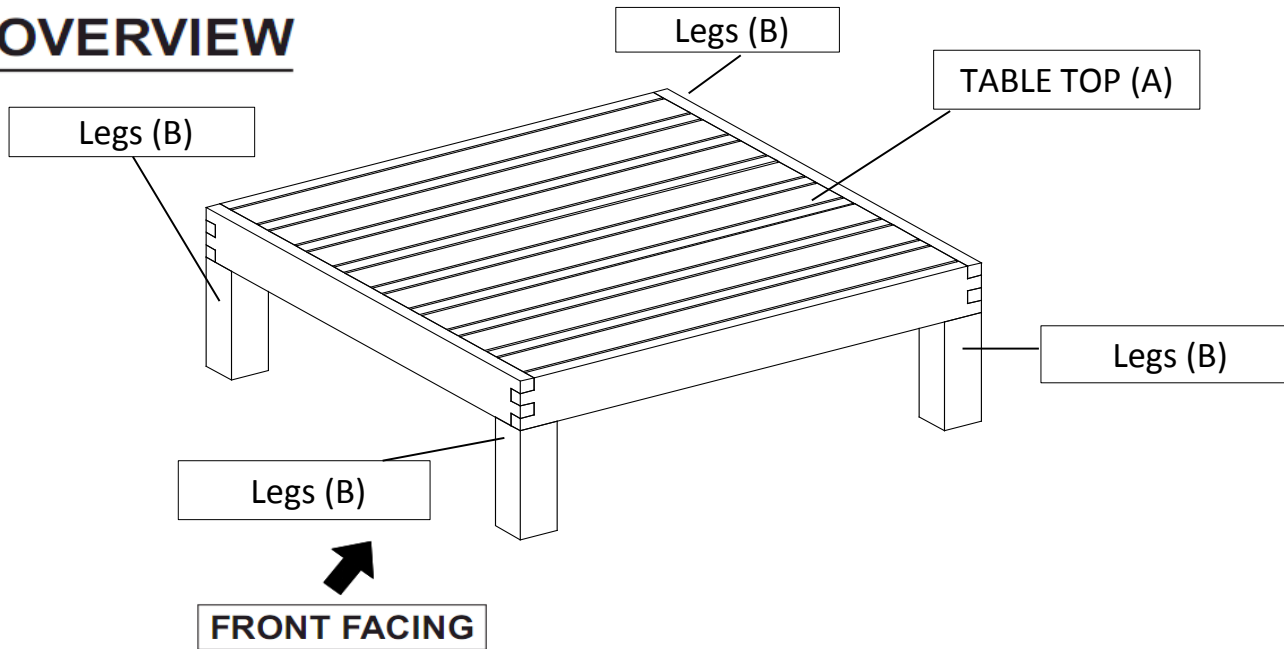

This Table has multiple parts and may require up to 30 minutes to assemble.  
To give you an overview of the Table parts, the above picture is to help you put the various parts into perspective.  
Please read through the instructions herebelow to familiarise the parts and steps before assembly.

### Step 1

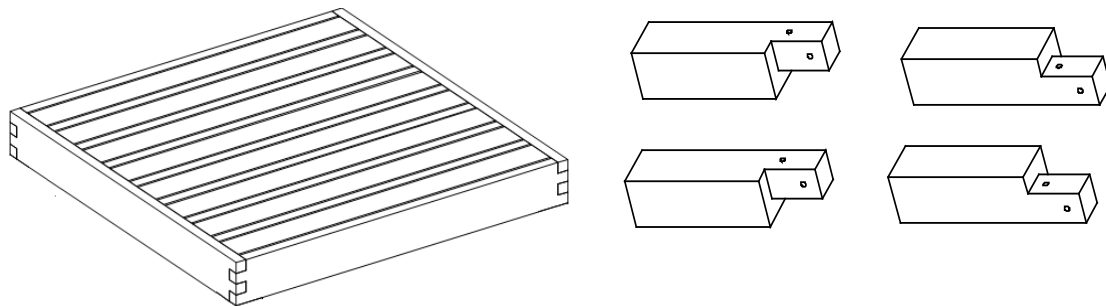

Unpack and place all parts on a clean, non-marring surface.

## Step 2

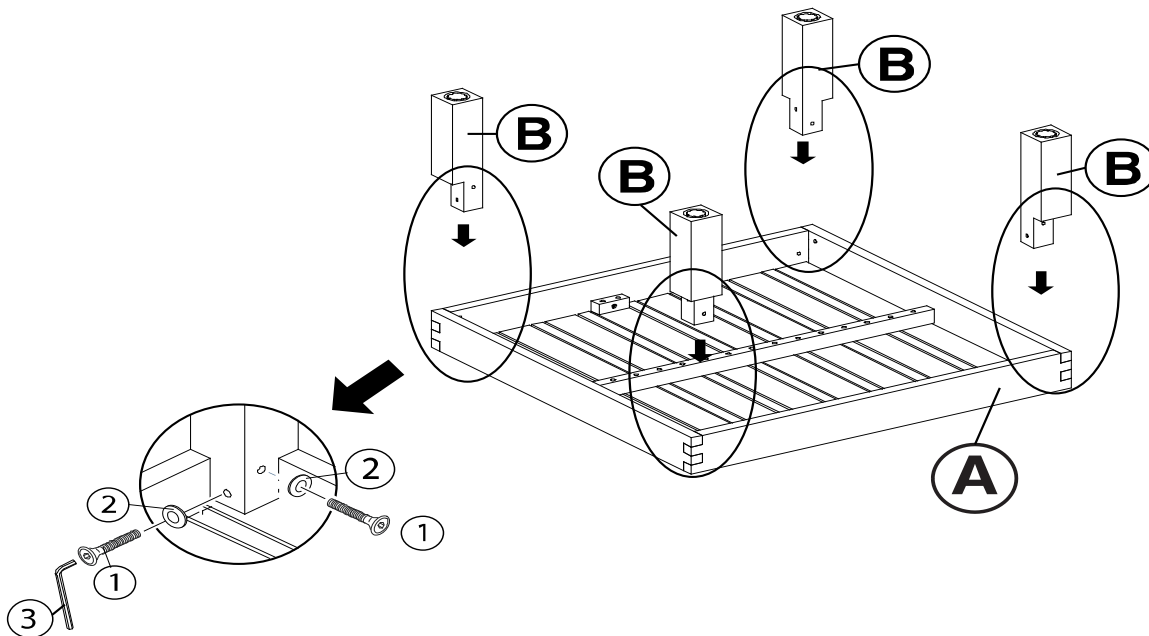

Place the Table Top (A) with its underside skywards onto a clean, soft surface to avoid any scratch or damage to the product.

Affix loosely the Legs (B), 2nd into the mounting position at the corners of the Table Top (A), using the Bolts (1) with Flat Washers (2), with the Allen Key (3), as shown above. Repeat the same process with the other Leg (B).

**CAUTION: When tightening these screws, tighten sequentially.**

**DO NOT** tighten any screw fully and then towards the next one.

**This would cause the frame to warp.**

**WARNING ! IF END TABLE IS NOT STABLE , IT COULD LEAD TO DAMAGING THE PRODUCT.**

## Step 3

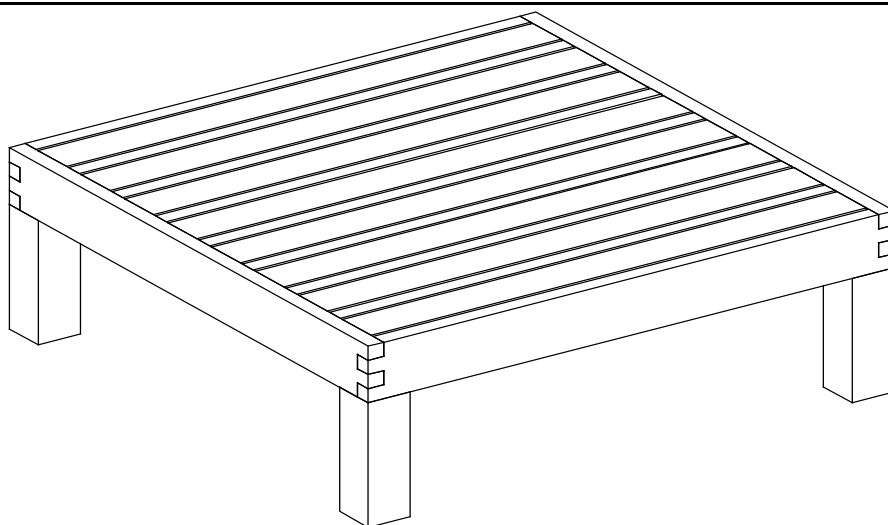



















Turn the Table right side up

Ensure all bolts are fully locked into position.

The Table is ready to be used.

**Caution: This Table can only be used on a flat, level surface.**

## Care & Maintenance

-   ● Do not put hot items directly on furniture surface
  -   ● Do not clean furniture with harsh cleansers or polish.
  -   ● To obtain the longest lifespan of your outdoor products, minimizing exposure to direct sunlight is recommended.
  -   ● Children should not climb or jump on the furniture.
  -   ● Do not write on furniture without a padded barrier to protect the surface.
  -   ● To obtain the longest lifespan of your outdoor products, avoid extended and lengthy exposure to rain, snow, and direct sunshine. Whenever possible cover the product and /or place under patio or awnings.
  -   ● Not for commercial use. For residential use only .
  -   ● Stains may be removed with mild soap solution and damp cloth.
- 
-   ● Dust and pick-up spills using a clean, non-colored, lint-free cloth .