

BAR CABINET

User Manual

SKU:BCF004-47BL-USZX

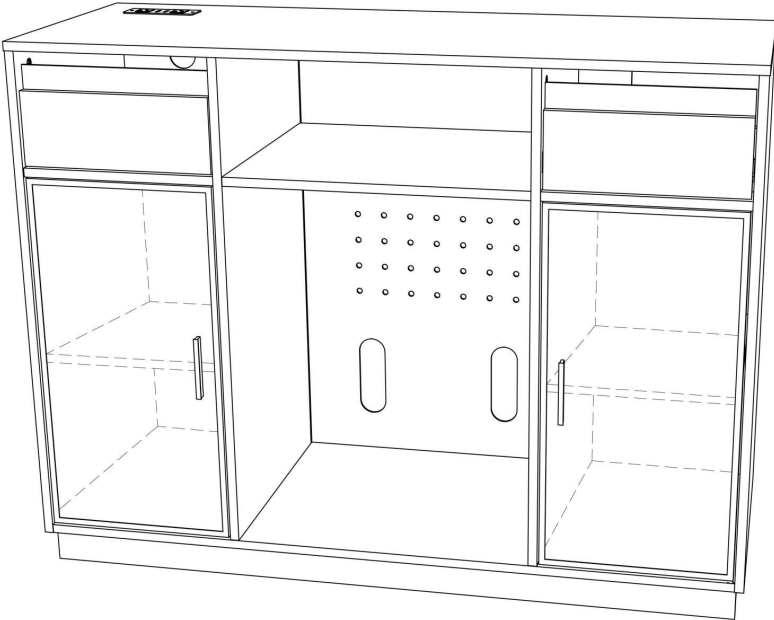

Contact Us

If you have any questions about the bar cabinet please contact customer service.

Email: Service@cozfurn.com

Scan the QR code to watch the installation video.



SAFETY PRECAUTIONS

Assembly Checklist

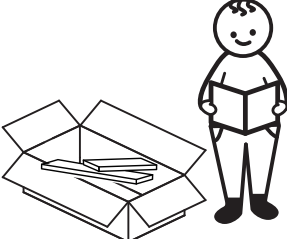
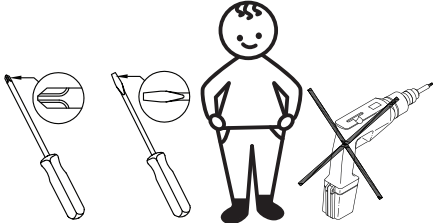
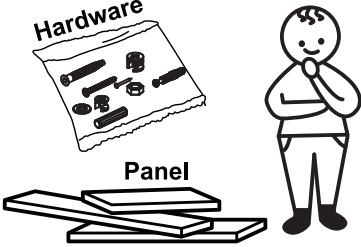
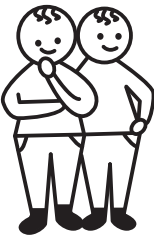
 <p>Read through the instructions carefully before you begin.</p>	 <p>Make sure you have all the required tools. Never use power tools unless instructed.</p>
 <p>Identify and lay out all of the components before you begin assembly.</p>	 <p>Two people are required to assemble.</p>

Useful Information

! Never use power tools unless specifically instructed. They can damage your components or hardware if used incorrectly.

! The most common mistakes made during assembly are using the wrong hardware or getting components back to front.

! Always use a soft surface (such as carpet or cardboard) when assembling your product to avoid scratching or damaging the surface of the product.

! Bulky items such as wardrobes and bunk beds should be assembled in the room they will be used in as they may not fit through a door once assembled.

! Never use any glue until you are certain that the parts belong together.

! Periodically check and re-tighten all fasteners. Check the product care label or website for product care instructions.

! If you are having any difficulties assembling your product, missing any hardware or components please email us.

SAFETY PRECAUTIONS

QUICKFIT

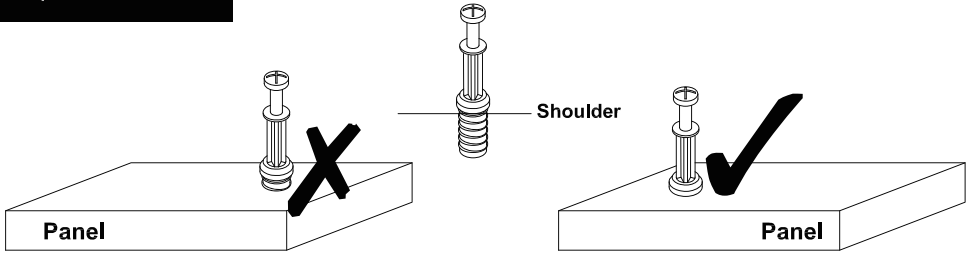

Tighten quickfit until shoulder is flush with panel. Do not overtighten or undertighten.

CAM LOCK

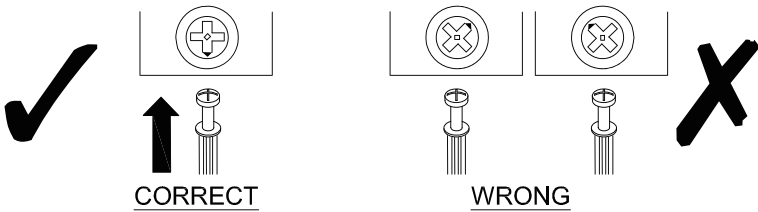

When fitting cam lock, ensure starting position is correct before you insert connecting quickfit.

Quickfit head should be in the centre of the cam lock when the two panels are joined. Cam lock should be inserted before quickfit.

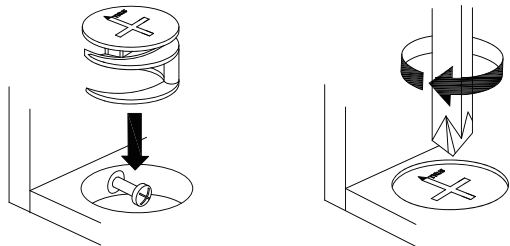

Turn cam lock clockwise to tighten.

SAFETY PRECAUTIONS

Wall Mounting & Fixing Guide

NOTE: Supplied wall plugs are only suitable for use in masonry walls.

If you have any doubts about using the correct plug for your wall, please seek professional advice.

Failure of the product due to using incorrect fixings is the responsibility of the installer.



IMPORTANT:

When drilling into walls, always check for hidden wires or pipes, etc.



Tips & Tricks

Make sure that the hardware used is suitable for supporting your unit.

Please consult a qualified tradesperson if unsure.

- If you are unsure, please select a larger screw and wall plug.
- Ensure that you use the recommended drill bit to match the wall plug and hole size.
- Take extra care when drilling high walls, ceiling and ceramic tiles. Ensure wall plugs are inserted beyond the thickness of the ceramic tiles to avoid splitting or cracking.
- Ensure that wall plugs are well fitted and are a tight fit in the drilled hole.

Types Of Walls

Use one of the following types of wall plug (not included) if your walls are made of brick, breeze block, concrete, stone or wood. Screws may be able to be fixed directly to solid wood walls as they will provide a secure anchor point.

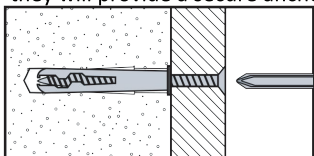

1. General Purpose Wall Plug

Generally, aerated blocks should not be used to support heavy loads, use a specialist fitting in this case. For light loads, general purpose wall plugs can be used.

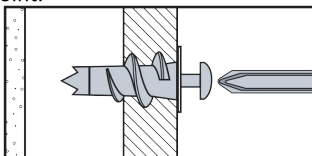

2. Plasterboard Wall Plug

For use when attaching light loads onto plasterboard partitions.

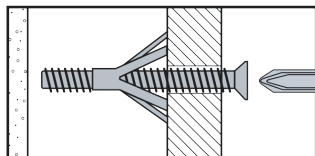

3. Cavity Fixing Wall Plug

For use with plasterboard partitions or hollow wooden doors.

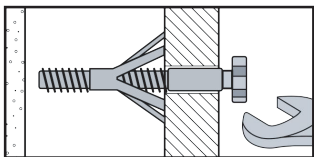

4. Cavity Fixing Heavy Duty Wall Plug

For use when fitting or supporting heavy loads such as shelving and wall cabinets.

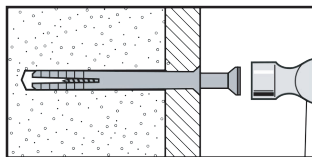

5. Hammer Fixing Wall Plug

For use with concrete block or brick walls, or walls stuck with plasterboard. The hammer fixing allows it to be fixed to the wall rather than the plasterboard. Always check the fixing is secure to the retaining wall.

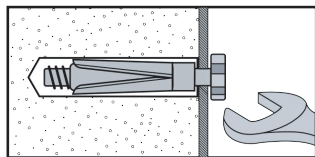

6. Shield Anchor Wall Plug Heavy Loads

For use with concrete or brick walls, or for use with heavier loads such as TV & HiFi speakers and satellite dishes, etc.

PRODUCT WARRANTY INSTRUCTION



Free Warranty Period:

The free warranty period starts from the product receipt date and lasts one year.



Coverage during the Free Warranty Period:

1. If any components of the purchased product are damaged due to non-human-induced reasons natural wear and tear excluded corresponding new parts will be replaced free of charge.

2. If the entire purchased product is damaged due to non-human-induced reasons natural wear and tear excluded and cannot be further used, corresponding parts or a brand-new product will be replaced free of charge.



Coverage after the Free Warranty Period:

After the warranty period expires, replacement components will be provided to customers at cost price for continued service.



Additional Services:

After purchasing the product, customers can consult our staff for any product-related inquiries.







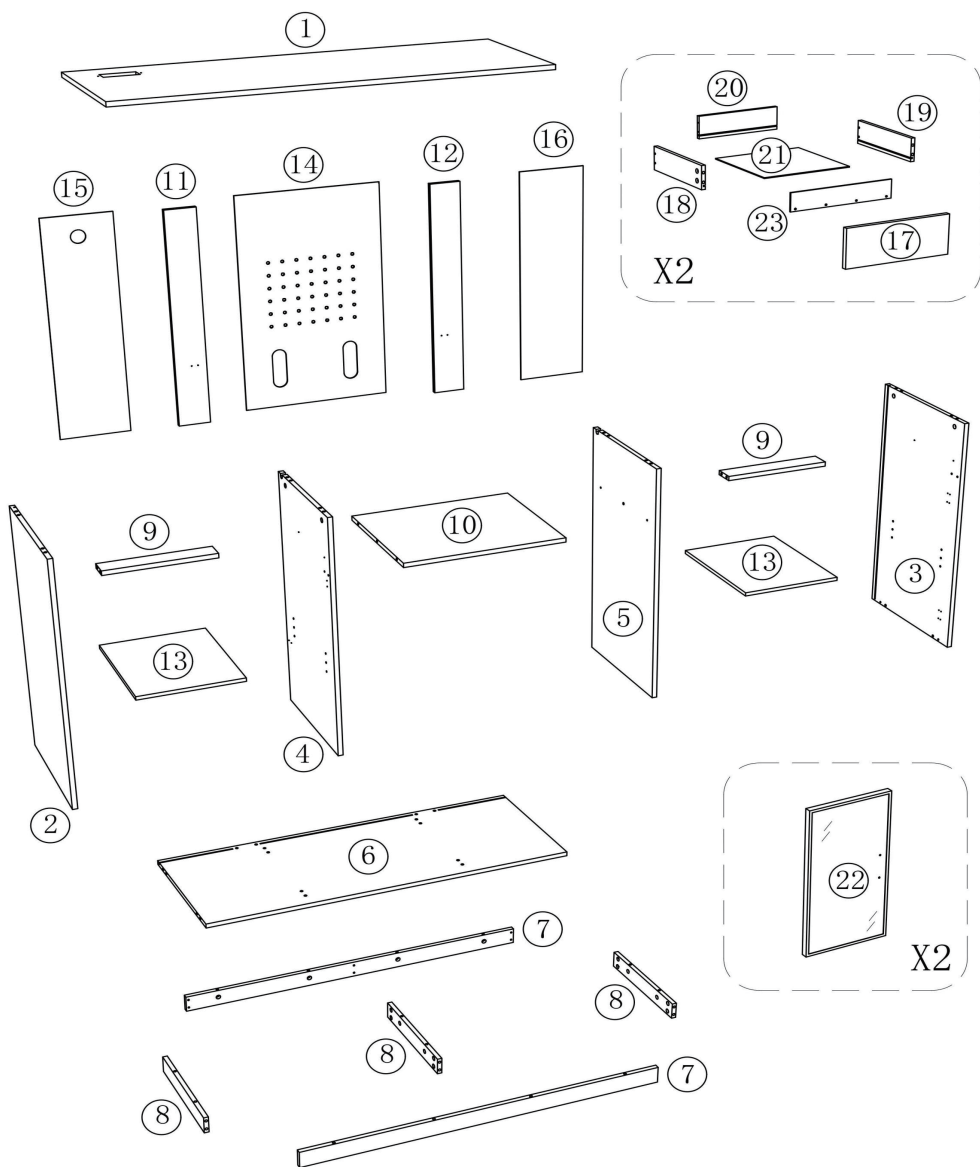





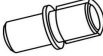

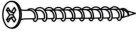









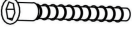





Contact Email : Service@cozfurn.com

ACCESSORIES DISPLAY



ACCESSORIES DISPLAY

<p>A X62</p> 	<p>B X54</p>  <p>Ø15X12</p>	<p>C X8</p>  <p>Ø15X10</p>	<p>D X8</p> 	<p>E X4</p>  <p>M4X9</p>
<p>F X10</p>  <p>M4X40</p>	<p>G X18</p>  <p>M4X14</p>	<p>H X2</p>  <p>96mm</p>	<p>I X4</p> 	<p>J X18</p>  <p>M8X40</p>
<p>K X18</p> 	<p>L X4</p> 	<p>M X2</p> 	<p>N X2</p> 	<p>O X38</p>  <p>M3X14</p>
<p>P X8</p>  <p>M6X40</p>	<p>Q X2</p> 	<p>R X2</p> 	<p>S X8</p> 	<p>T X1</p> 
<p>U X8</p>  <p>M4X14</p>	<p>V X10</p>  <p>M3X12</p>	<p>W X8</p>  <p>M4X7</p>	<p>X X1</p> 	<p>Y X1</p> 
<p>DR X2</p> 	<p>CR X2</p> 			
<p>DL X2</p> 	<p>CL X2</p> 			

PRODUCT ASSEMBLY

STEP 1

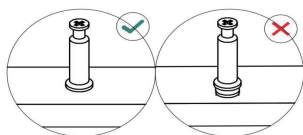
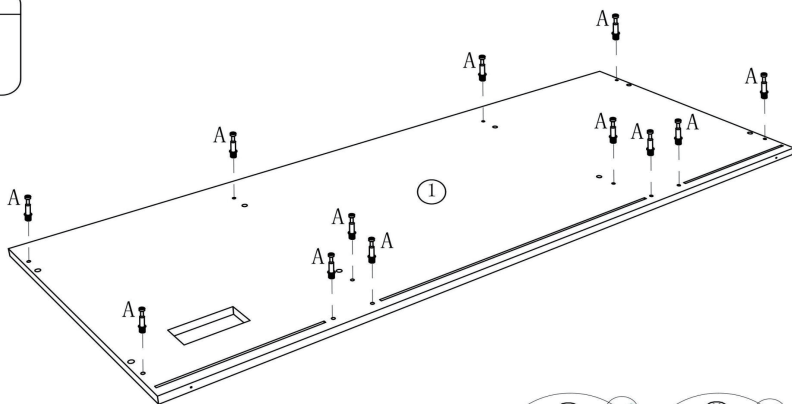
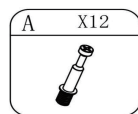

STEP 2

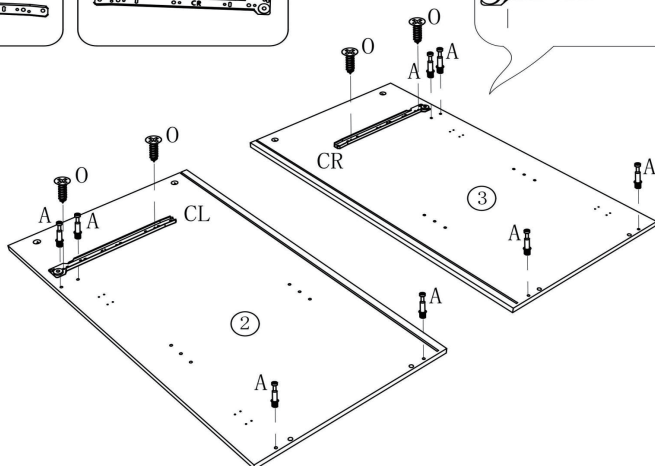
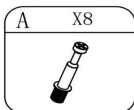
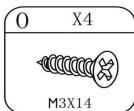
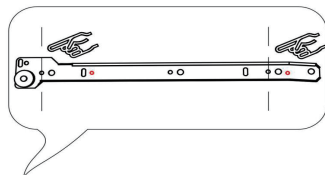
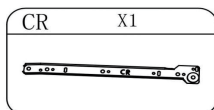
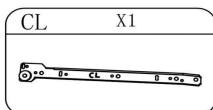

PRODUCT ASSEMBLY

STEP 3

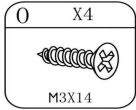
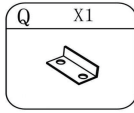
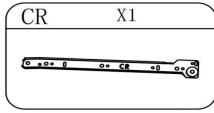

M3X14

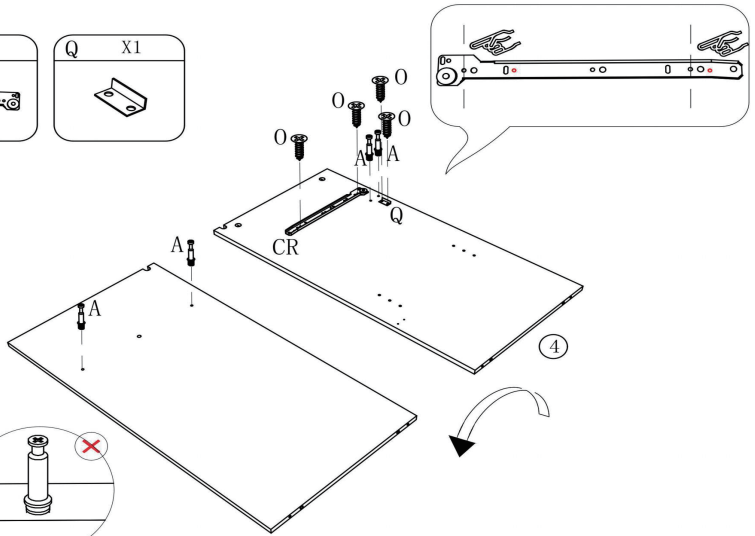
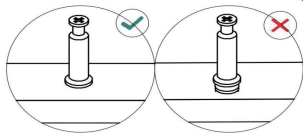
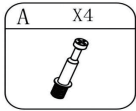

STEP 4

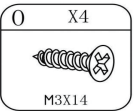
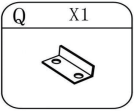
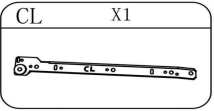

M3X14

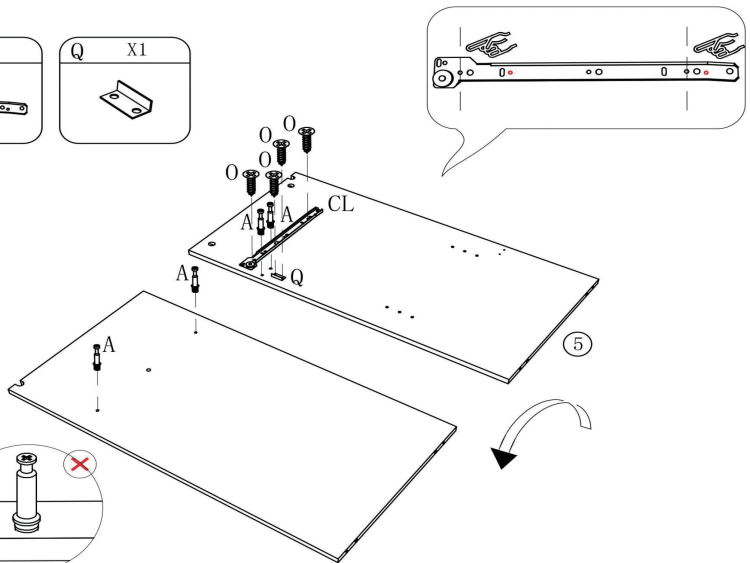
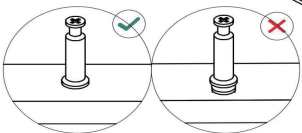
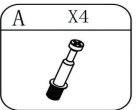

PRODUCT ASSEMBLY

STEP5

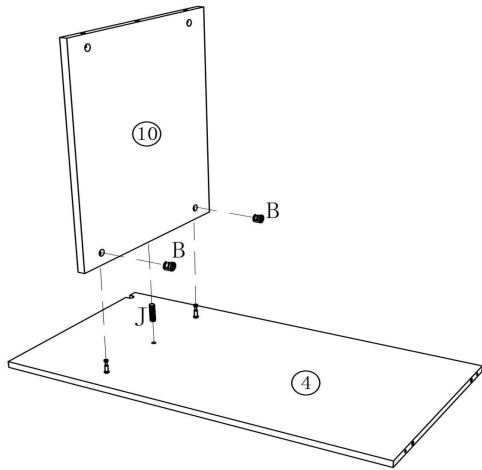
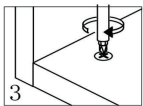
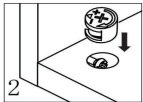
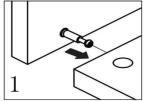
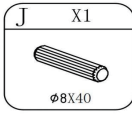
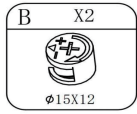

STEP6

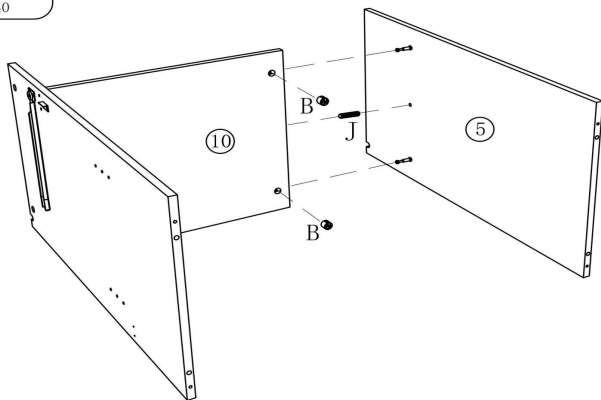
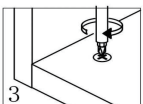
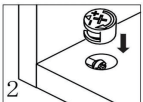
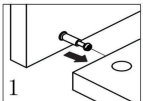
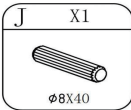
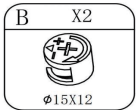

PRODUCT ASSEMBLY

STEP 7

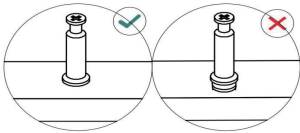
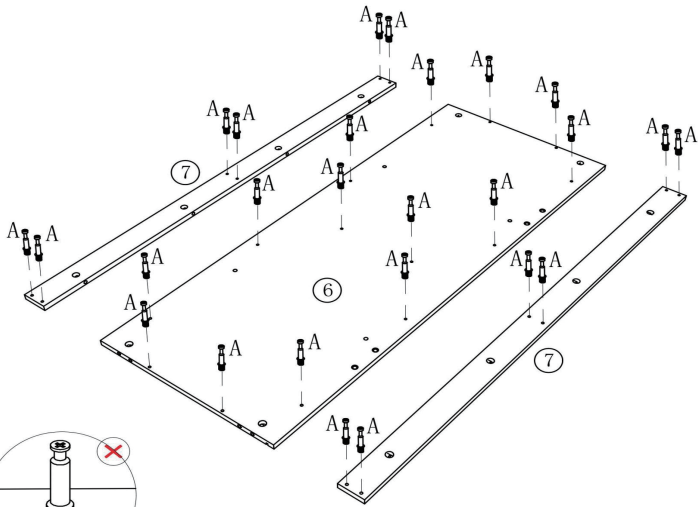
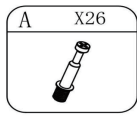

STEP 8

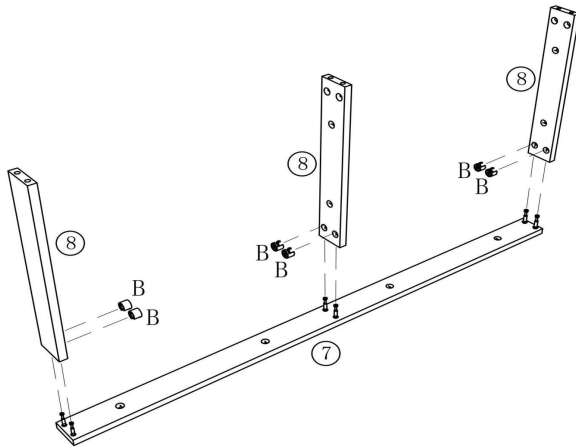
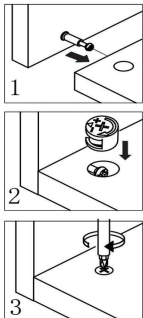
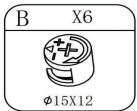

PRODUCT ASSEMBLY

STEP9

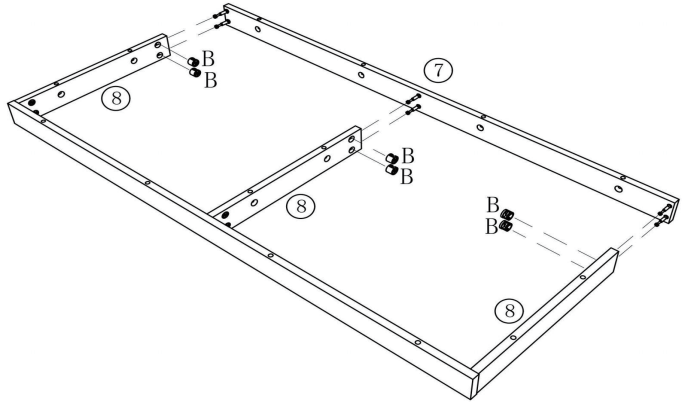
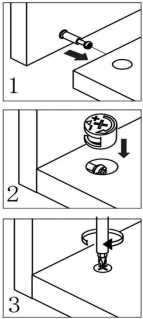
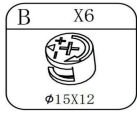

STEP10

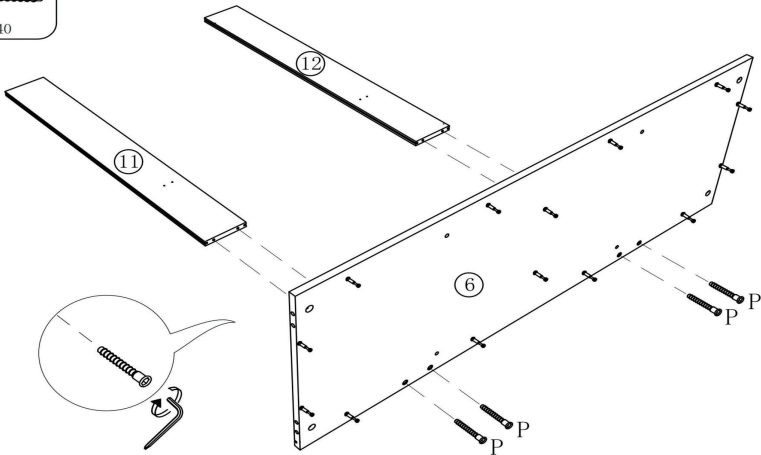
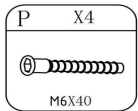

PRODUCT ASSEMBLY

STEP 11

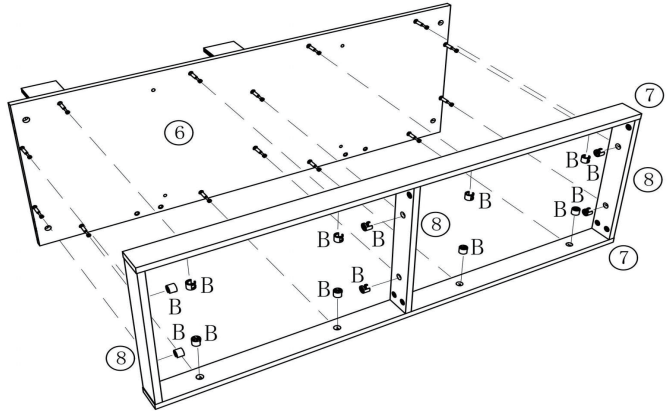
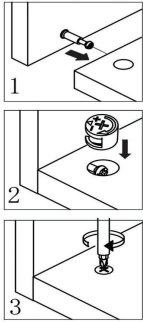
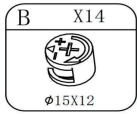

STEP 12

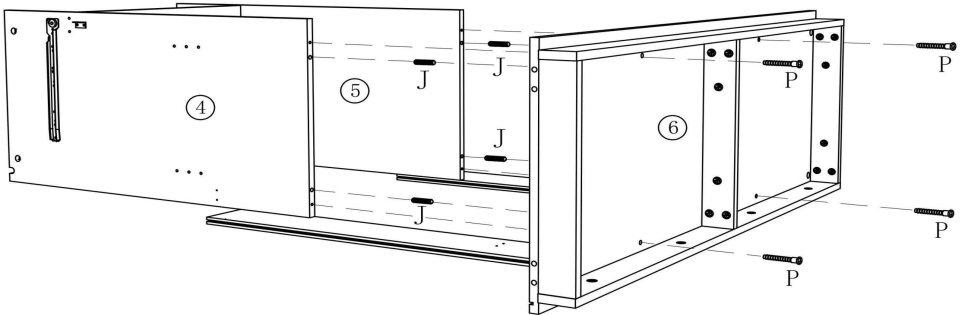
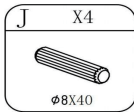
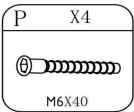

PRODUCT ASSEMBLY

STEP 13

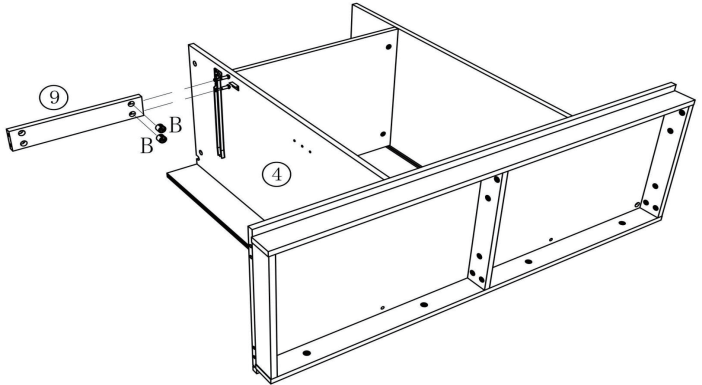
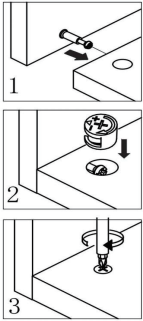
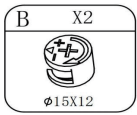

STEP 14

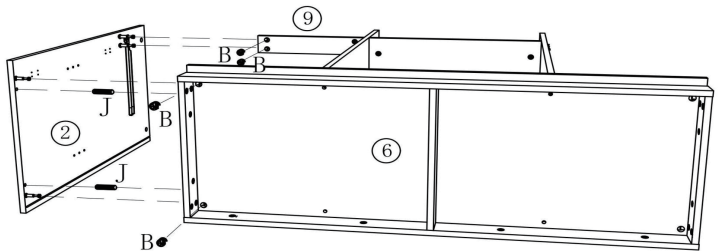
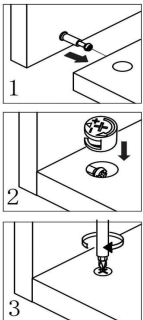
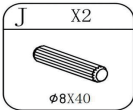
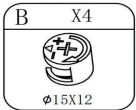

PRODUCT ASSEMBLY

STEP 15

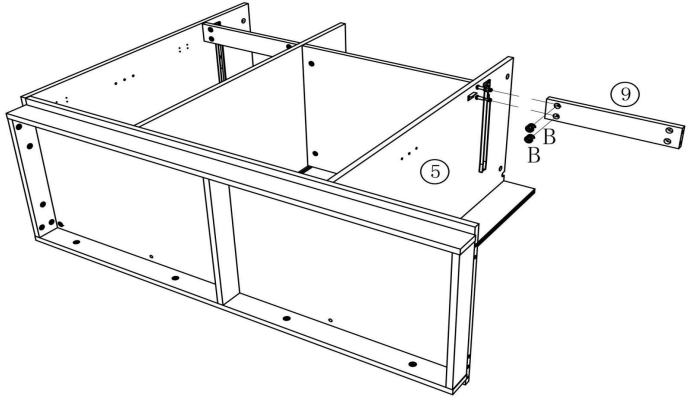
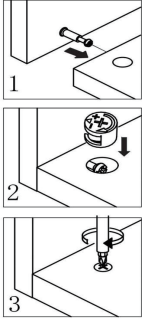
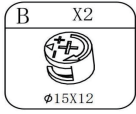

STEP 16

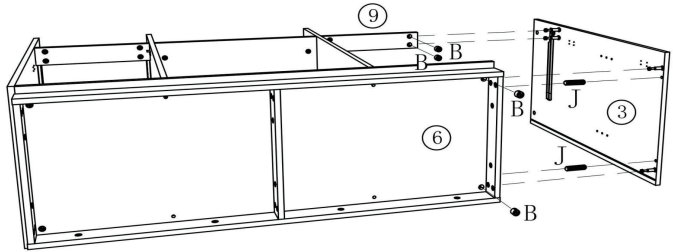
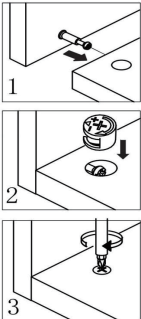
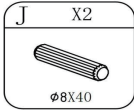
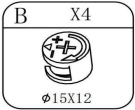

PRODUCT ASSEMBLY

STEP 17

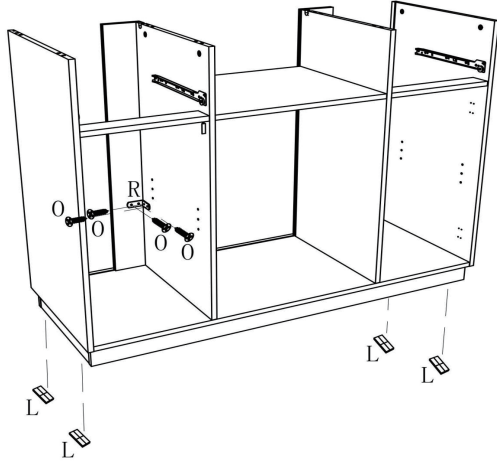
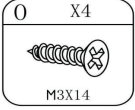
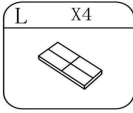
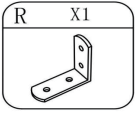

STEP 18

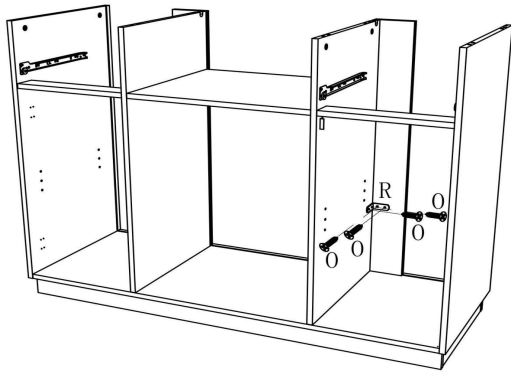
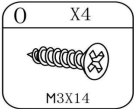
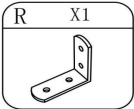

PRODUCT ASSEMBLY

STEP19

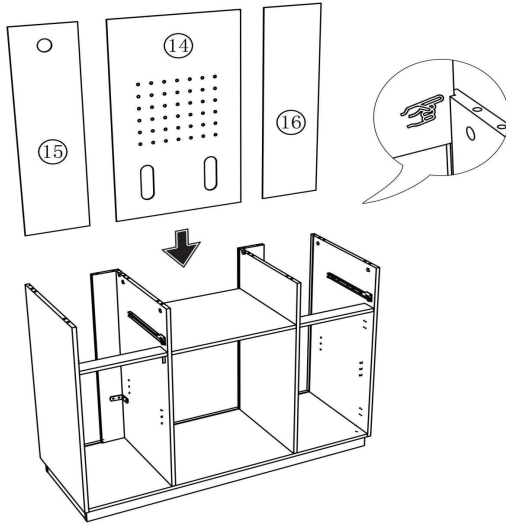

STEP20

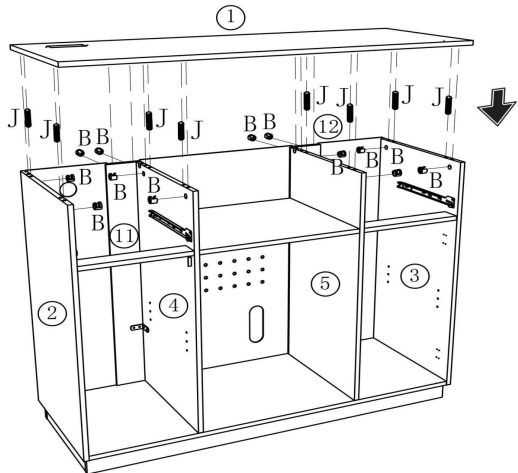
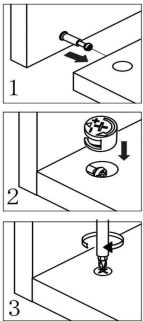
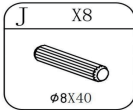
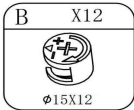

PRODUCT ASSEMBLY

STEP21

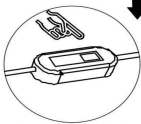
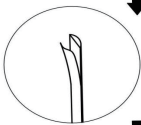
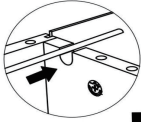
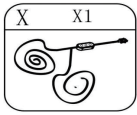

Scan this
QR code

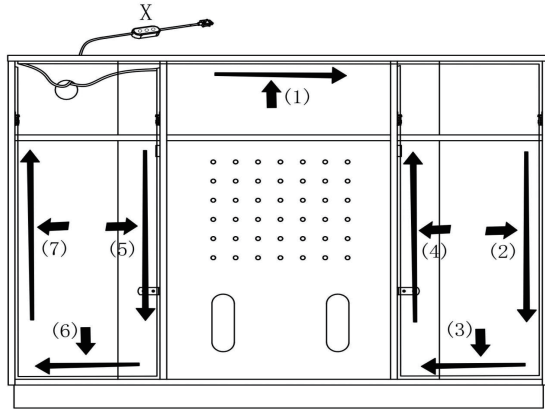

For reference only,
you can also DIY.

STEP22

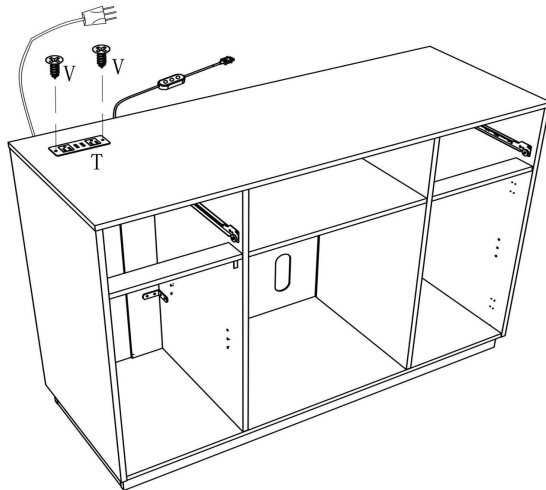
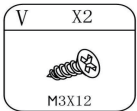
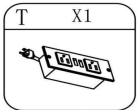

PRODUCT ASSEMBLY

STEP23

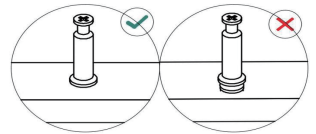
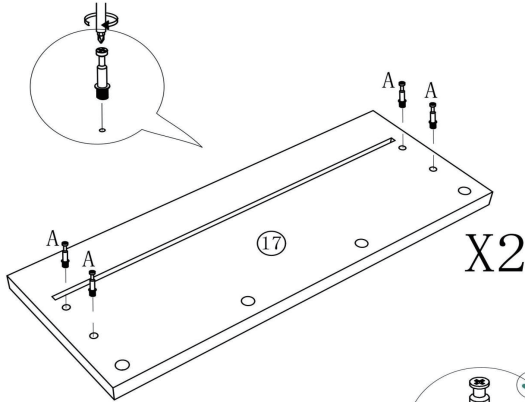
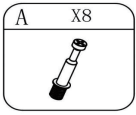

STEP24

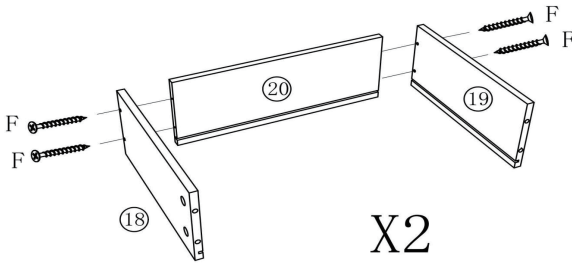
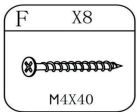

PRODUCT ASSEMBLY

STEP25

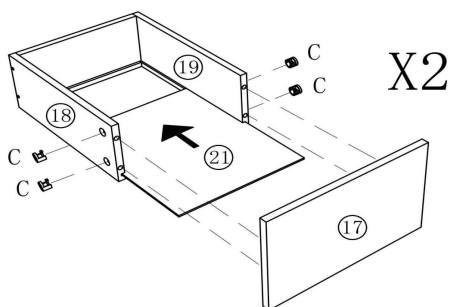
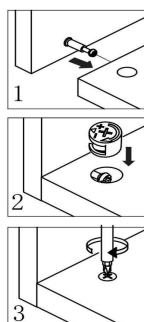
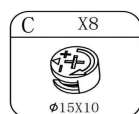

STEP26

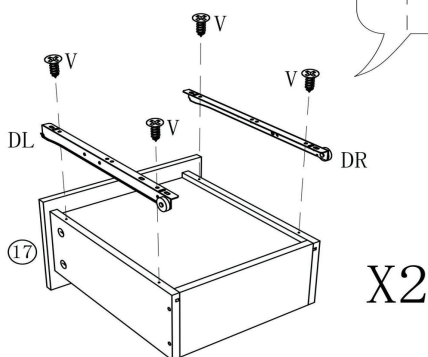
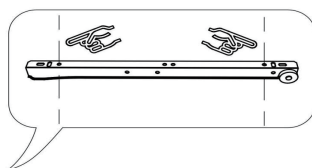
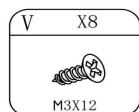
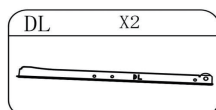
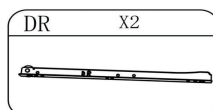

PRODUCT ASSEMBLY

STEP29

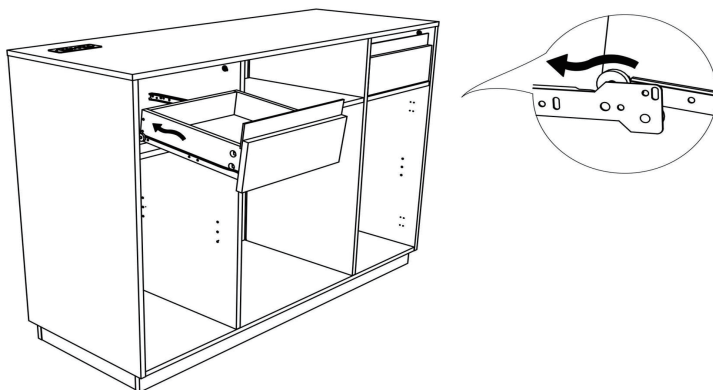

STEP30

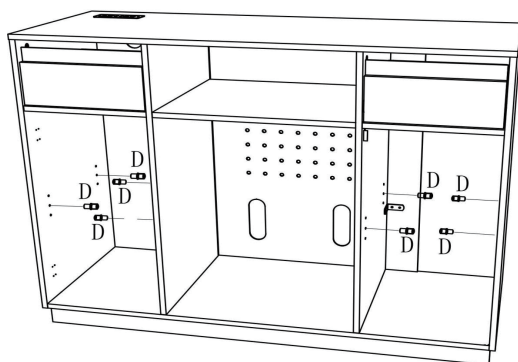
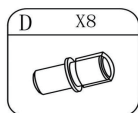

PRODUCT ASSEMBLY

STEP31

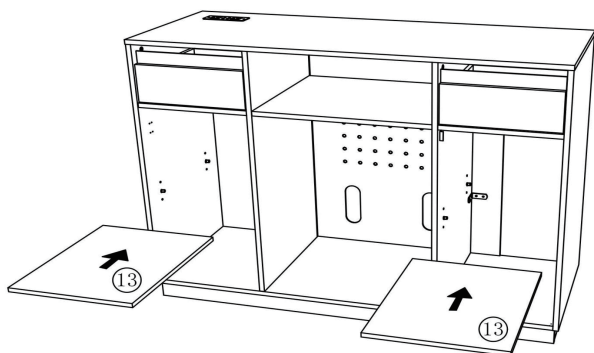

STEP32

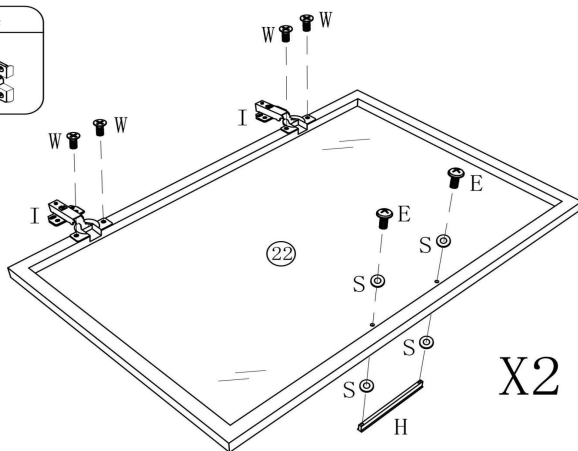
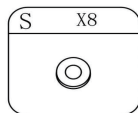
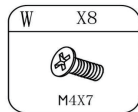
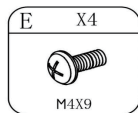
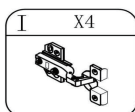
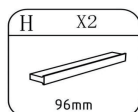

PRODUCT ASSEMBLY

STEP33

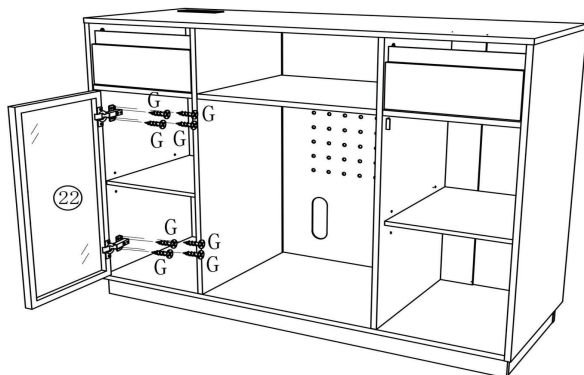
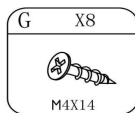

STEP34

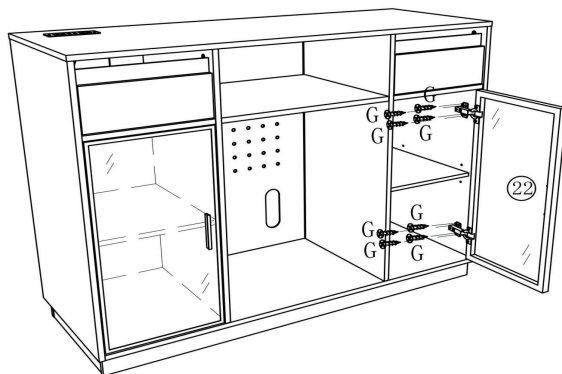
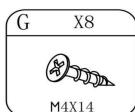

PRODUCT ASSEMBLY

STEP35

Adjust front and back.

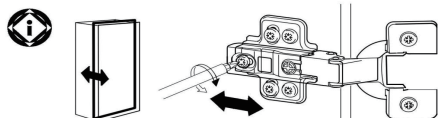

Adjust left and right.

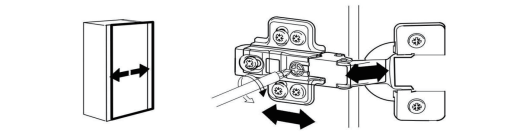

STEP36

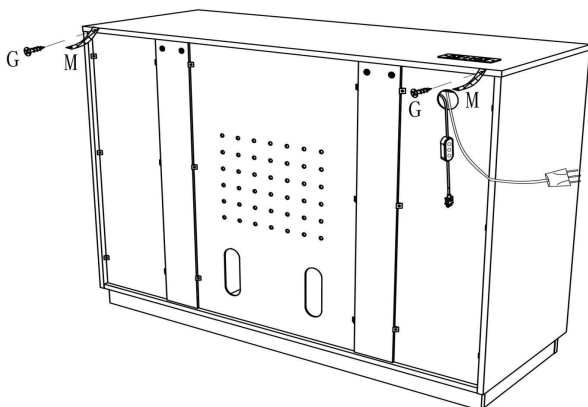
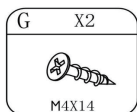
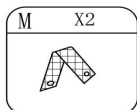

PRODUCT ASSEMBLY

STEP37

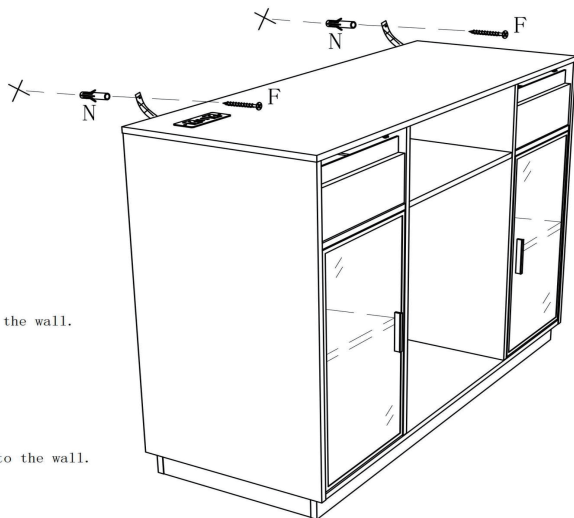
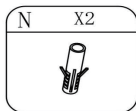
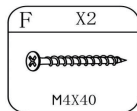

1, Mark on the wall.



2, Drill holes in the wall.

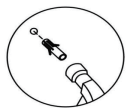

3, Push in the plastic plug.

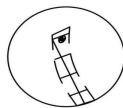

4, Long screws into the wall.