

# ASSEMBLING INSTRUCTION

ORLANDO COT 120x60

ITEM:8520



**IMPORTANT!KEEP FOR FUTURE REFERENCE**

## TOOLS REQUIRED



## IMPORTANT INFORMATION

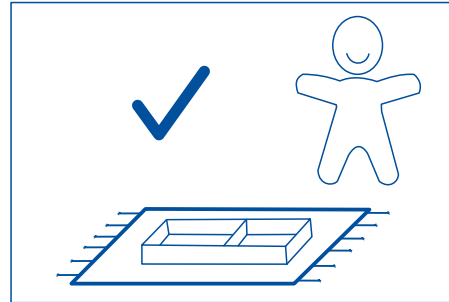
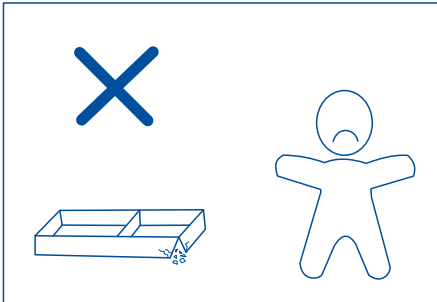
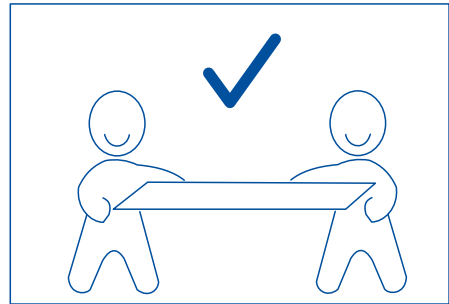
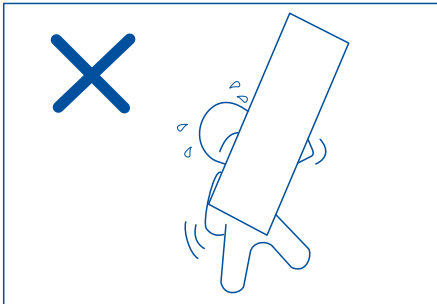
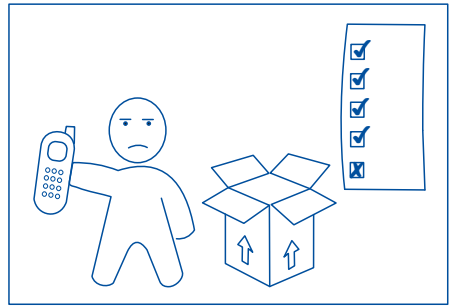
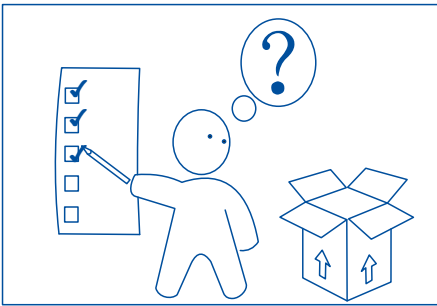

## PARTS CHECKLIST

A

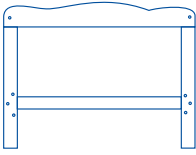

Headboard(2pcs)

B



Footboard(2pcs)

C

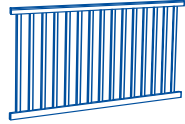

Rail(2pcs)

D

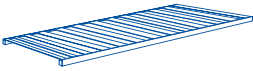

Slats(1pc)

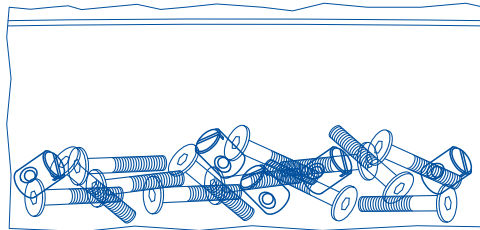

H



M5x50 (16pcs)

I



M6X16(16pcs)

J

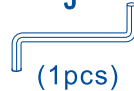

(1pcs)  
To tighten all screws

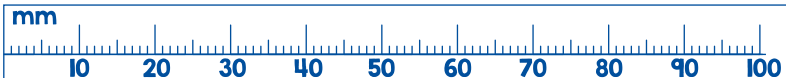

## ASSEMBLY DIAGRAM

**1** To connect **(A)** Headboard(2pcs) and **(B)** Footboard(2pcs)

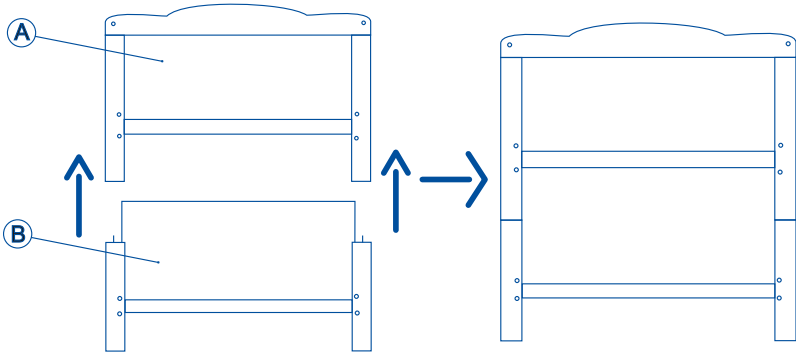

**2** To install **(A)** Headboard and **(B)** Footboard to **(D)** Slats

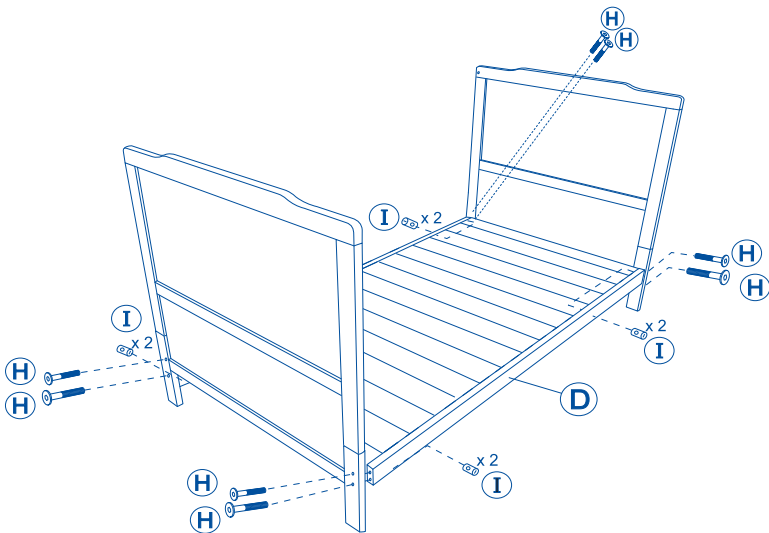

## ASSEMBLY DIAGRAM

- 3** To install © Rails(2pcs)to Headboard, Footboard and Slantd

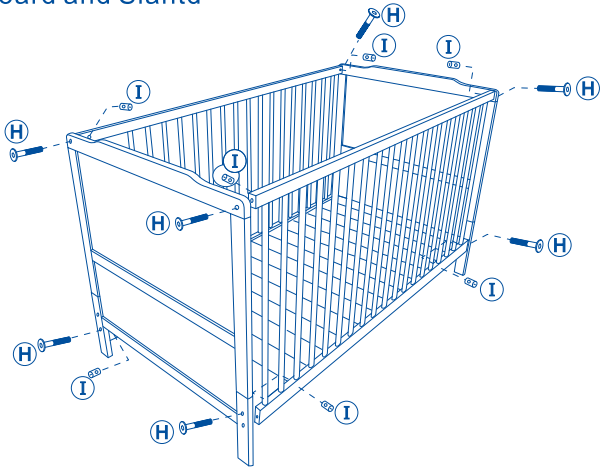

DO THIS FOR ALL FOUR CORNERS



Fully tighten all bolts

Your bed is now ready for use.

## ASSEMBLY DIAGRAM

- 5** To convert Baby Cot to Toddler Bed
- Remove **B** Footboard and **C** Rails
  - Connect **A** Headboard to **D** Slats

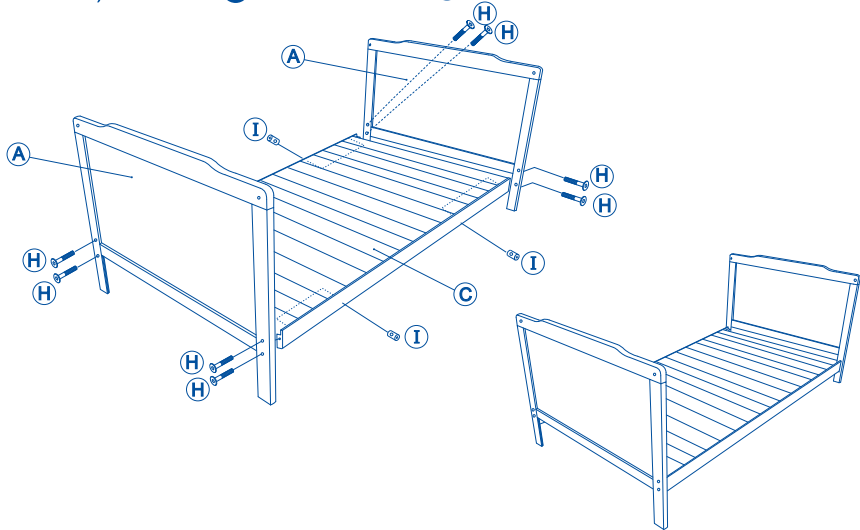

Fully tighten all bolts  
Your bed is now ready for use.

## Safety & care notes

### IMPORTANT, RETAIN FOR FUTURE REFERENCE: READ CAREFULLY!

**WARNING: TO PREVENT FALLS, THE MATTRESS BASE OF THE COT SHOULD BE ADJUSTED TO THE LOWEST POSITION BEFORE THE CHILD CAN SIT UP.**

This user guide must be followed in detail to ensure the safety features of the cot/bed are not compromised.

**WARNING:** Be aware of the risk of open fire and other sources of strong heat, such as electric bar fires, gas fires, etc., in the vicinity of the cot/bed.

**WARNING:** Do not use the cot/bed if any part is broken, damaged, torn or missing, approved replacement parts can be obtained from dealer.

**WARNING:** Do not leave anything in the cot/bed, or place it close to another product which could provide a foothold or present a danger of suffocation or strangulation, For example strings, blind/curtain cords etc.

**WARNING:** Do not use more than one mattress in the cot. ensure the gap at the sides and the ends does not exceed 25mm.

**WARNING:** Children are likely to play, bounce, jump and climb on beds, therefore the child's bed should not be placed too close to other furniture or windows, and should be placed either tight to any wall or have a gap of 300mm between the wall and the side of the bed.  
The size of the mattress to be used with child's bed is 1200 mm long by 600 mm wide and up to 100 mm in thickness.

**The product confirms to BS EN 716,BS 8509.**

Cots which convert to beds are intended from birth up to approximately 5 years.

The lowest position of the mattress base in the safest, and should be used as soon as the baby is old enough to sit up.

The width and length are specified because it is important that the gaps between the mattress and the sides and the ends of the cot will not exceed 25mm, This is to minimise the risk of a child's limb becoming caught in the gap. The thickness of the mattress has been specified to ensure that the depth of the cot is greater than 500mm with the mattress base in the lower position to minimise the risk of a child climbing or falling out of the cot.

Ensure the cot is placed at a reasonable distance from curtains, heaters and power points.  
Always keep medication, string, elastic, small toys or similar small items out of reach from any position of the cot.

To prevent injury from falls, when the child is able to climb out of the cot, the cot shall no longer be used for that child.

Thickness of the mattress chosen must not reduce the internal depth (from mattress surface to top of the side) to less than 500mm with the base in its lowest position or 200mm with the base in its highest position.

All assembly fittings should be tightened properly, checked regularly and re-tightened as necessary.

Screws and bolts should not be loose because a child can squeeze parts of the body, or clothing (e.g. strings, necklaces, ribbons for babies dummies etc.) could get caught, There would be a danger of strangulation.

The cot/bed must be used on a level and stable surface, away from electric sockets. Once assembled do not dismantle. Never move the cot/bed with a child in it.

Excessive chewing may damage the wood and cause splintering. If any part is damaged stop using.

Your cot/bed can be cleaned by with a damp cloth and drying with a soft clean cloth.

Do not use abrasives, bleach, alcohol or ammonia based household polishes.

Take care when handling or moving, Careless handling can damage wooden furniture.

Wood is a natural material, the colour will darkened with age.

## CUSTOMER CARE

**Your child's safety is your responsibility**

If you have a problem with this product or require replacement parts, please contact store.