

ASSEMBLY MANUAL

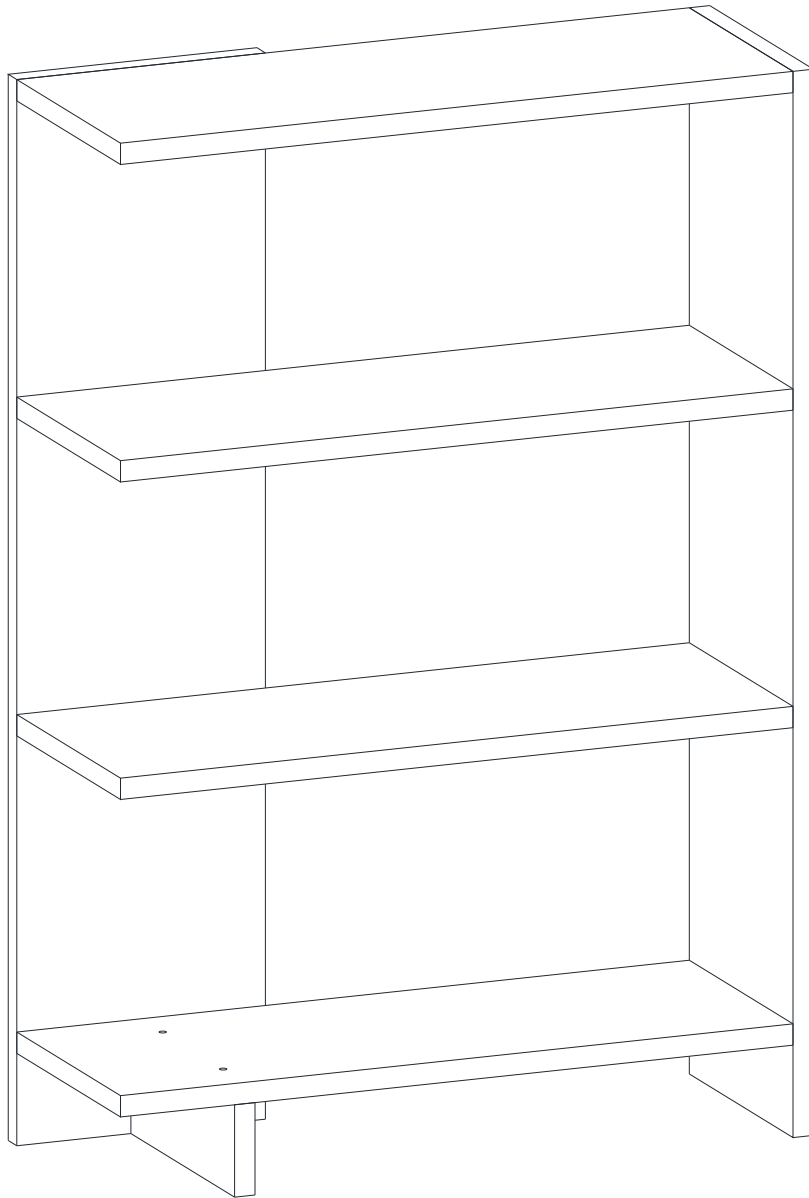

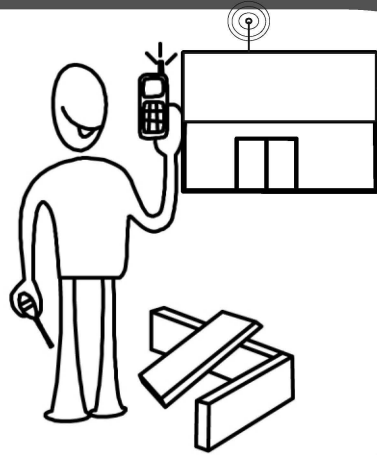

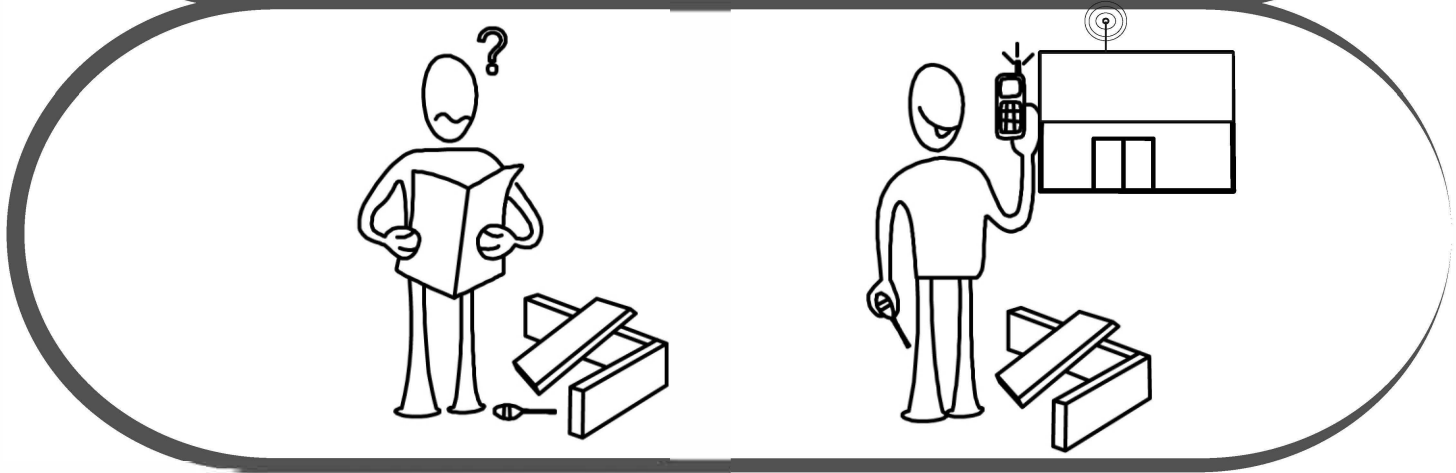
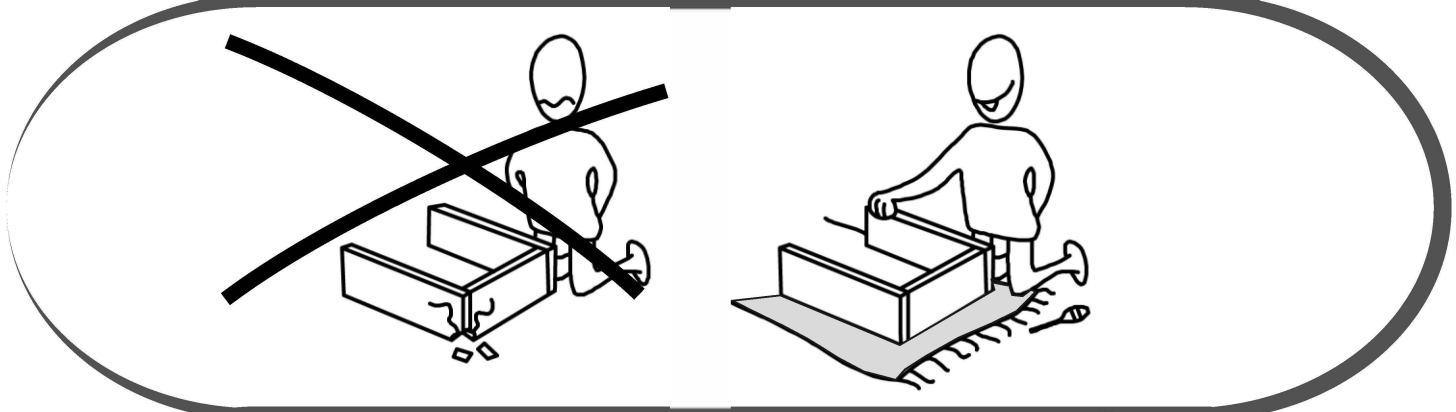
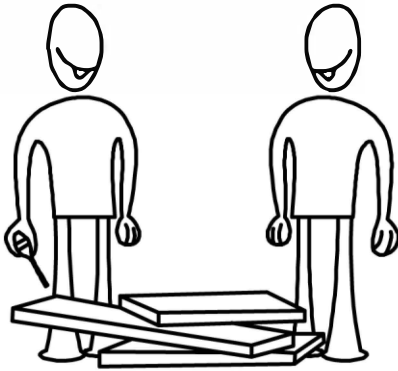
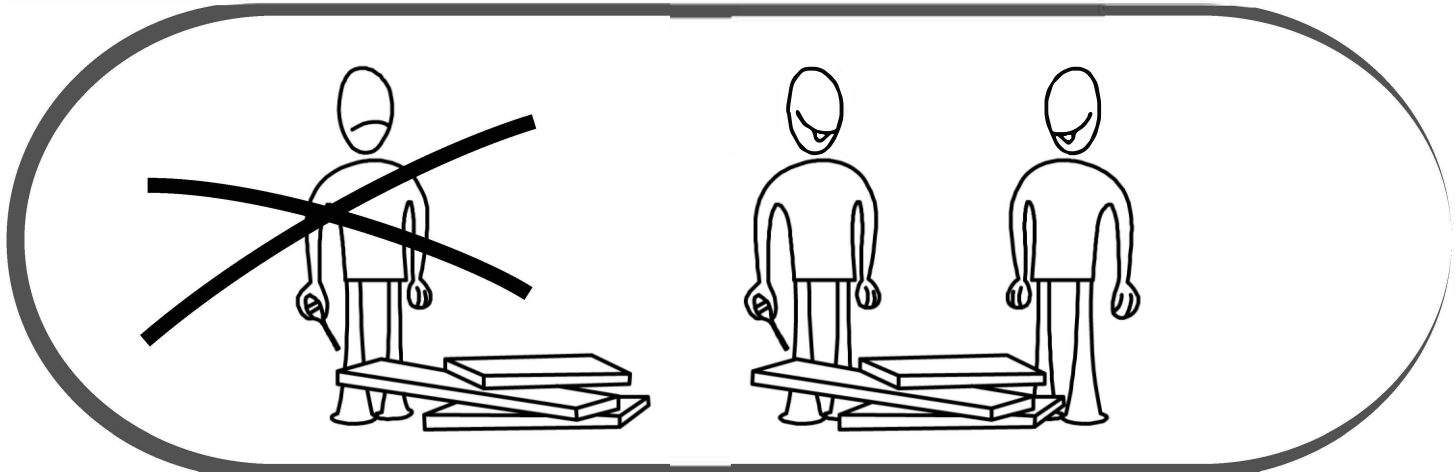
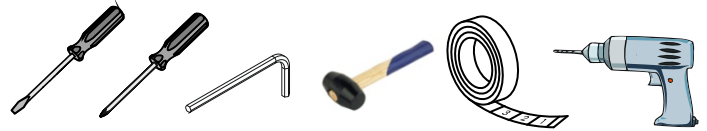

This unit should be assembled by two persons.



ACCESSORY LIST

A09	4x50 YHB Screw		Cover
	18x		18x

GENERAL VIEW

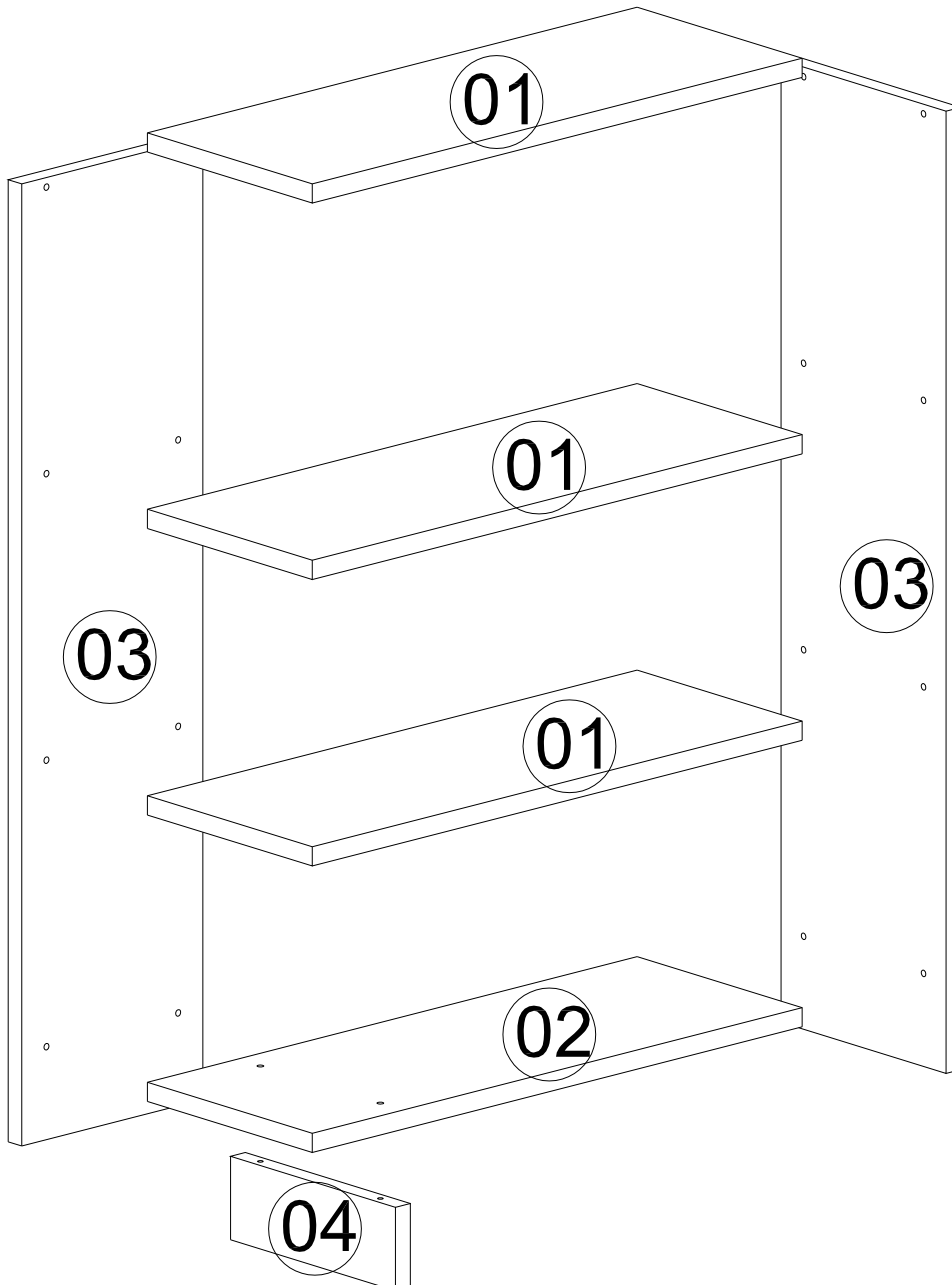

ASSEMBLY MANUAL

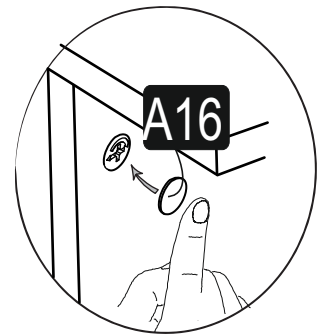
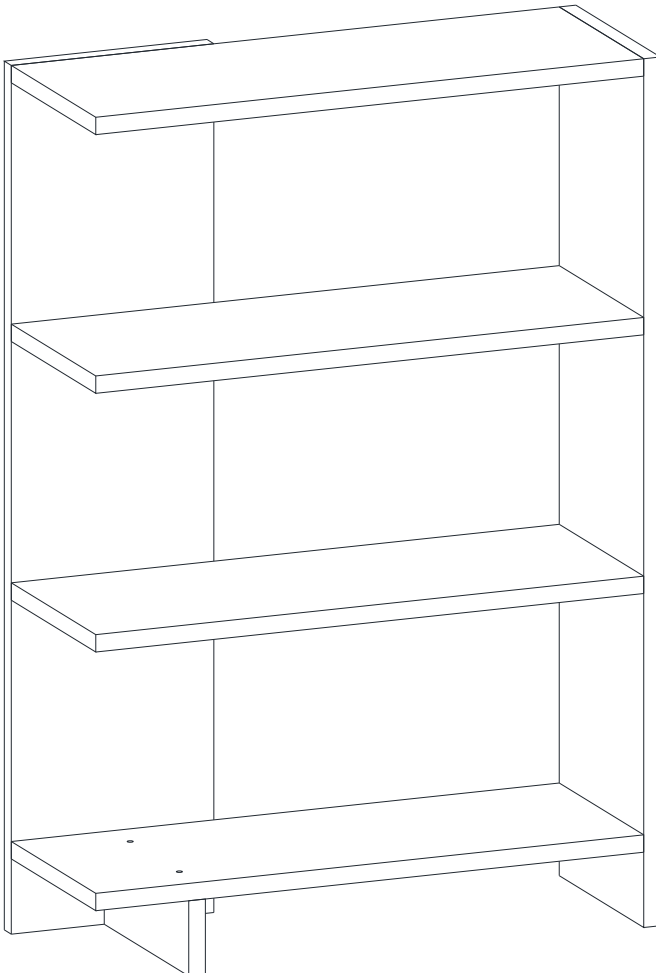
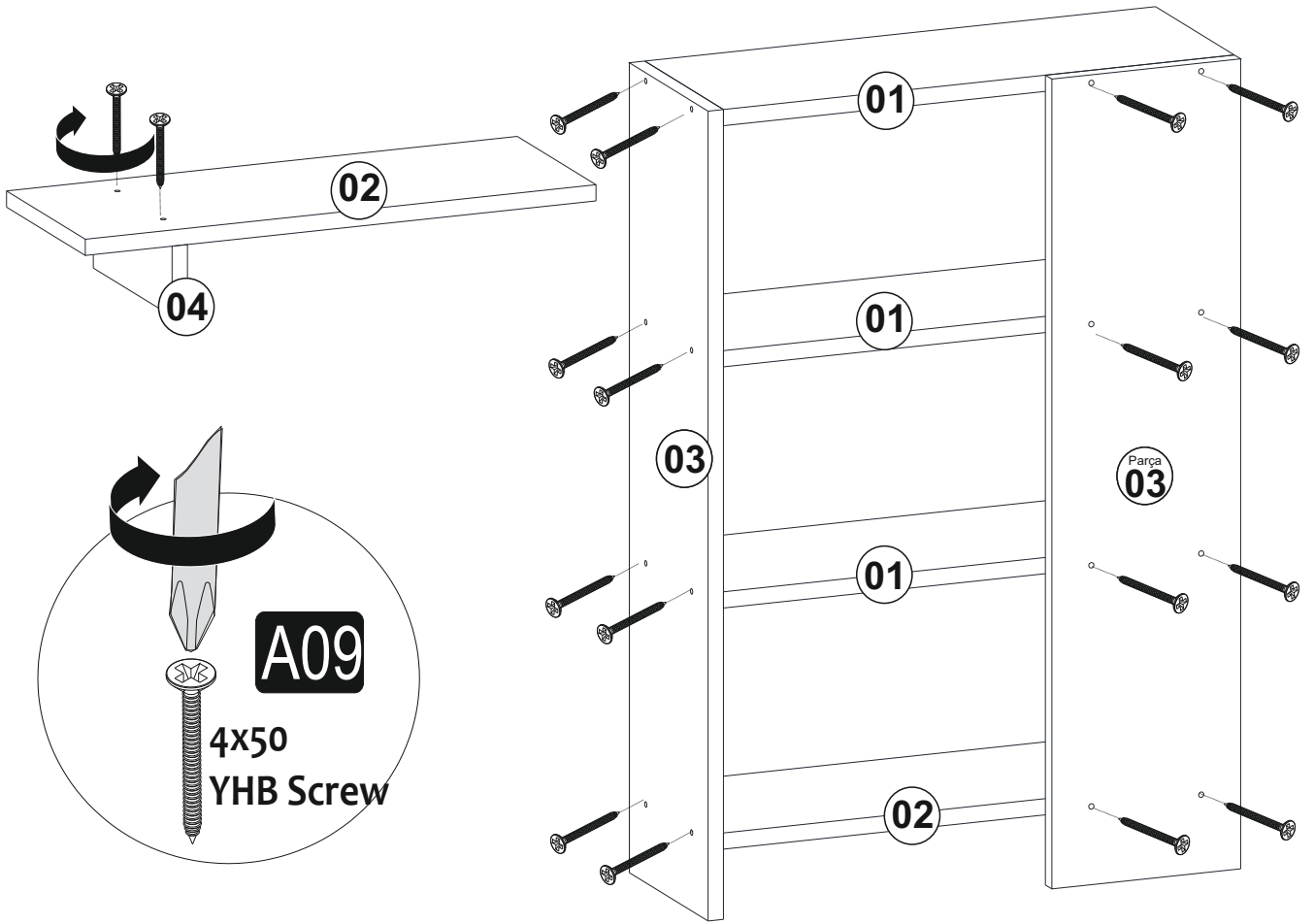



WARNING

CHOKING HAZARD

- This unit contains small parts which could be a choking hazard for small children. Children should be under adult supervision at all times.
- Do not overload the unit. Each shelf has a recommended capacity of 13 pounds, and the total weight on the unit should not exceed 39 pounds for wall shelves.
- Do not climb, step, or stand on the unit.
- Do not mount or attach items to the front, rear, or sides of the unit. This can cause the unit to become unbalanced and fall.
- Do not stack units.
- All units must be secured individually to wall studs using hardware provided. If wall studs are not accessible, consult your local hardware store for appropriate mounting hardware.
- We recommend you hand-tighten screws. Use care not to overtighten if using power tools. Follow proper safety procedures if using power tools and/or ladders.
- We recommend you protect your work surface during assembly to prevent scratching or damage to tabletops, wood floors, etc.
- Failure to follow the instructions listed here could result in bodily injury or damage to personal belongings. Use caution and follow safety procedures.