







Assembly Instruction

2830-4103/4113/4104/4114 Low post bed

Parts & Hardware List

PARTS LIST		Q'ty
A	HEADBOARD	1 PC
B	RIGHT POST	1 PC
C	LEFT POST	1 PC
D	FOOTBOARD	1 PC
E	BUN FOOT	2 PCS
F	SIDE RAIL	2 PCS
G	SLAT ROLL	1 PC
H	FINIAL	4 PCS

HARDWARE LIST			QTY
1	SHORT BOLT		8 PCS
2	LOCK WASHER		14 PCS
3	FLAT WASHER		14 PCS
4	WRENCH		1 PC
5	WOOD SCREW		8 PCS
6	LONG BOLT		6 PCS

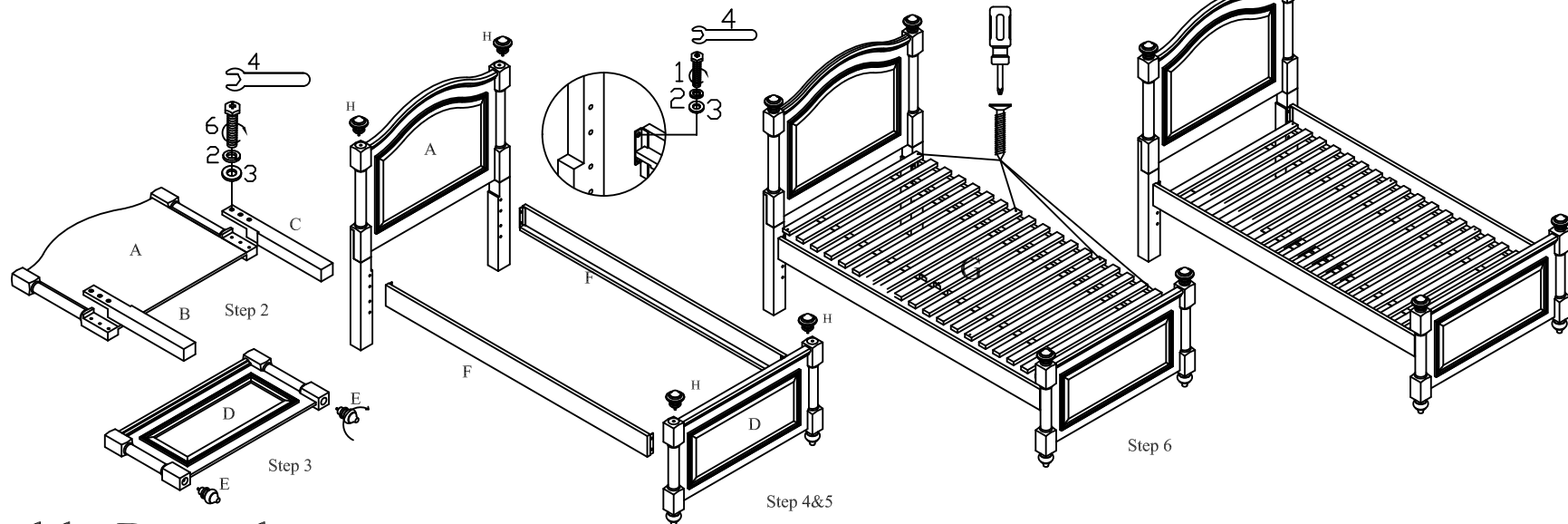

Assembly Procedures:

Step 1: Lay out all parts and hardware. Make sure the quantity of each is correct.

Step 2: Assemble the headboard (A) to right & left posts (B&C).

Step 3: Assemble the bun foot (E) to footboard (D).

Step 4: Assemble the side rails (F) to headboard (A) and footboard (D).

Step 5: Assemble the finial (H) to headboard (A) and footboard (D).

Step 6: Put the slat roll (G) on the bed cleats, spread out and fasten wood screws.

Assembly is complete.