

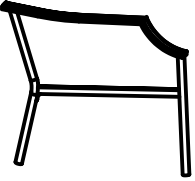





# ASSEMBLY INSTRUCTIONS

PF19007

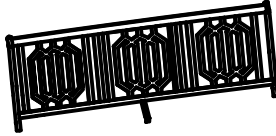
|  |  |  |   |
|--|--|--|---|
|           |           |  |  |
| A 1pc  | B 1pc  | C 1pc  | D 1pc   |
| <br>M6*20 | <br>M6*40 |  |   |
| H 9pcs   | I 4pcs   | L 1pc  |   |
| 1<br>    | 2<br>   |  |   |
| 3<br>   |  |  |   |

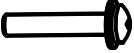
## ASSEMBLY TIPS:

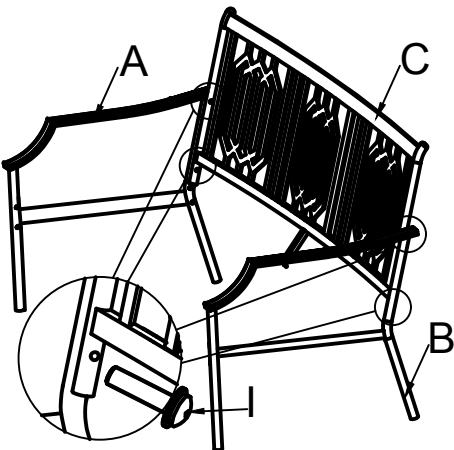
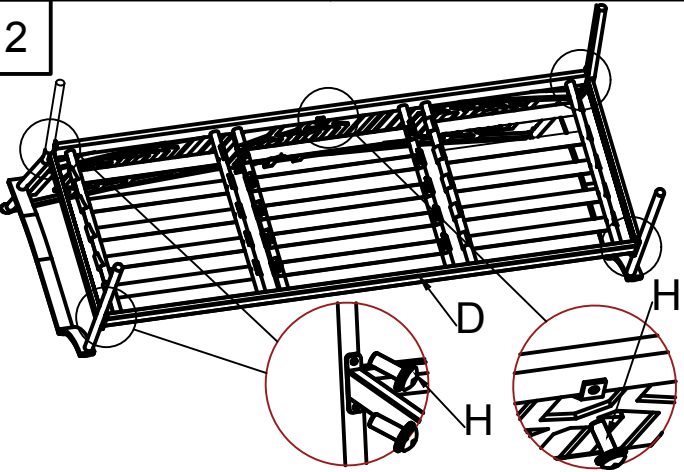
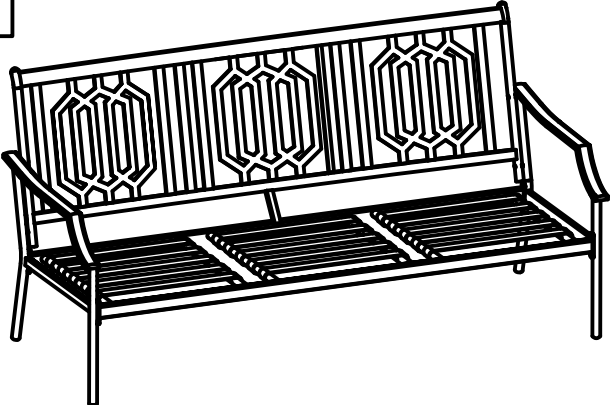
Please use the hardware and accessories included in the set. DO NOT use other electrical or manual tools. In order to facilitate the assembly and make your final product firm and stable, please tighten by a few rounds each screw one by one. After all screws are connected, then you start to tighten each screw to the end. DO NOT tighten any screw to the end before you have connected all screws. The assembly requires minimal level of DIY skills if you follow the instructions carefully. In case you encounter any difficulty or have any questions, feel free to contact the store or manufacturer.

# ASSEMBLY INSTRUCTIONS

PF19007

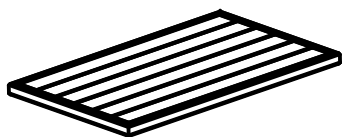

E 1pc

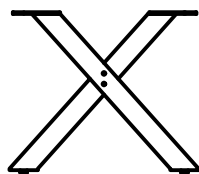

F 2pcs



G 1pc

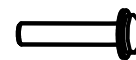

M6\*50

J 4pcs



M6\*15

K 8pcs



L 1pc

1

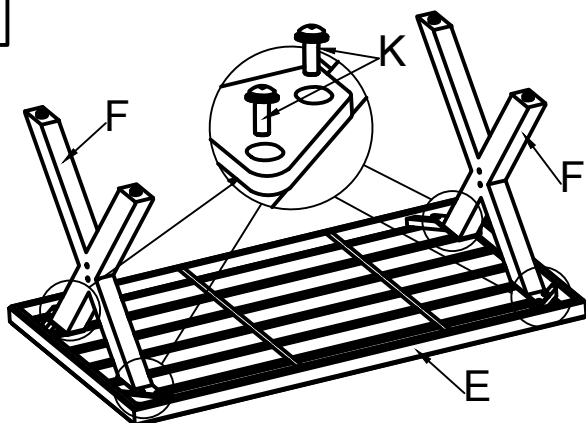

2

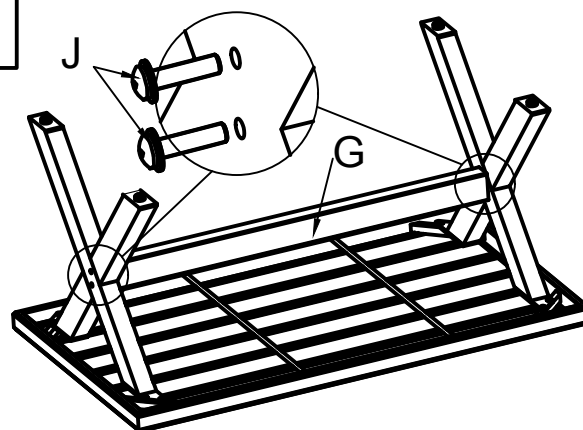

3

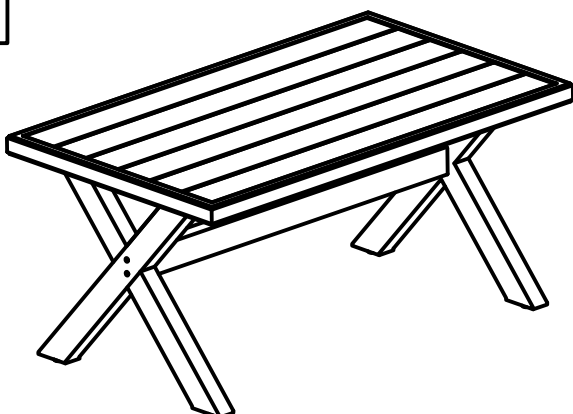







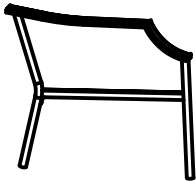
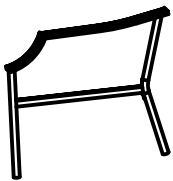

## ASSEMBLY TIPS:

Please use the hardware and accessories included in the set. DO NOT use other electrical or manual tools. In order to facilitate the assembly and make your final product firm and stable, please tighten by a few rounds each screw one by one. After all screws are connected, then you start to tighten each screw to the end. DO NOT tighten any screw to the end before you have connected all screws. The assembly requires minimal level of DIY skills if you follow the instructions carefully. In case you encounter any difficulty or have any questions, feel free to contact the store or manufacturer.

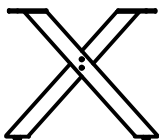
# Packing List

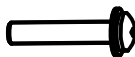
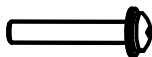
PF19007

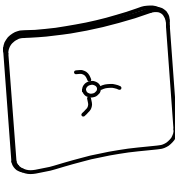
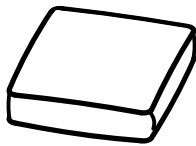
|   |  |  |  |  |
|---|--|--|--|--|
|            |   |           |            |           |
| A 1pc   | B 1pc  | C 1pc  | D 1pc  | E 1pc  |
|            |   | <br>M6*20 | <br>M6*40 | <br>M6*50 |
| F 2pcs  | G 1pc  | H 9+2pcs   | I 4+1pcs   | J 4+1pcs   |
| <br>M6*15 |  |          |           |  |
| K 8+2pcs  | L 1pc  | M 3pcs   | N 3pcs   |  |

**WARNING:**

Cushions must be put away in rainy and windy days in case they are diminished or blown away.

**ASSEMBLY TIPS:** Please use the hardware and accessories included in the set. DO NOT use other electrical or manual tools. In order to facilitate the assembly and make your final product firm and stable, please tighten by a few rounds each screw one by one. After all screws are connected, then you start to tighten each screw to the end.

DO NOT tighten any screw to the end before you have connected all screws.

The assembly requires minimal level of DIY skills if you follow the instructions carefully. In case you encounter any difficulty or have any questions, feel free to contact the store or manufacturer.