

# ASSEMBLY INSTRUCTION

## INSTRUCTIONS D'ASSEMBLAGE

EK BED / KING BED / TRES GRAND LIT  
KING HEADBOARD, FOOTBOARD, SLATS & SUPPORT LEGS  
QUEEN / EK SIDE RAILS

Thank you for purchasing this product. Please take time to read and follow the instruction below. Check that you have all parts and hardware before assembly. Parts apparently missing are often found in the packing materials. If you do not have all the parts listed, have your dealer contact us and they will be sent to you immediately.

Merci d'avoir achete ce produit. Veuillez lire et suivre les instructions ci-dessous. Verifiez avant le montage que vous avez toutes les pieces et fixations. Les pieces qui semblent manquer se trouvent souvent dans les materiaux d'emballage. Si vous n'avez pas toutes les pieces de la liste, demandez a votre detailliant et nous vous les enverrons immediatement.

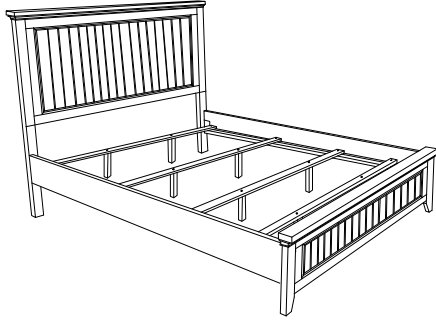

It is recommended to install protective pads under all legs and supports to avoid damage or scratches when placing furniture on a wood floor or other hard surface, and to limit indentation and prevent discoloration if placing on carpet.



Il est recommande de placer des coussins protecteurs sous tous les pieds et toutes les bases des meubles pour eviter d'endommager ou d'egrantigner les planchers en bois ou autres surfaces dures, et pour limiter l'empreinte et empecher la decolorations quand les meubles reposent sur la moquette.



Hardware may loosen over time. Periodically check to make sure all connections are tight. Re-tighten if necessary.



Le matériel peut se desserrer au fil du temps. Vérifiez périodiquement que toutes les connexions sont serrées. Serrer à nouveau si nécessaire.



Foundation/box spring required, sold separately.



Fondation/sommier tapissier requis, vendu séparément.

### 1581K-1 PART LIST / LISTE DE PIECES

NO	SKETCH	DESCRIPTION	QTY/PCS
1		HEADBOARD / TETE DE LIT	1 PC
2		HEADBOARD LEG - LEFT / PIED GAUCHE	1 PC
3		HEADBOARD LEG - RIGHT / PIED DROITE	1 PC
4		FOOTBOARD / PIED DE LIT	1 PC
5		SLAT / LATTES	4 PCS
6		SUPPORT LEG / SUPPORT POUR TRANSVERSE	8 PCS

### 1581-3 PART LIST / LISTE DE PIECES

NO	SKETCH	DESCRIPTION	QTY/PCS
7		SIDE RAIL / LONGERON	2 PCS

NOTE : YOU WILL ALSO NEED A PHILIP SCREWDRIVER (NOT PROVIDED)  
REMARQUE: VOUS AUREZ EGALEMENT BESOIN D'UN TOURNEVIS (NON INCLUS)

### HARDWARE LIST / LISTE DE QUINCAILLERIE

NO	SKETCH	DESCRIPTION	QTY/PCS
A		JCBC BOLT / BOULON M6 x 40mm	6 PCS
B		SPRING WASHER / RONDELLE D'ARRET M6	6 PCS
C		FLAT WASHER / RONDELLE PLATE 19mm	6 PCS
D		ALLEN KEY / CLE ALLEN M4	1 PC
E		ALLEN KEY / CLE ALLEN M5	1 PC
F		SCREW / VIS M4 x 32mm	8 PCS
G		JCBC BOLT / BOULON M6 x 50mm	8 PCS

\*ABOVE HARDWARE ARE PACKED FOR ASSEMBLY.  
\*LE QUINCAILLERIE EST DANS POUR L'ASSEMBLAGE.

# ASSEMBLY INSTRUCTION INSTRUCTIONS D'ASSEMBLAGE

EK BED / KING BED / TRES GRAND LIT  
KING HEADBOARD, FOOTBOARD, SLATS & SUPPORT LEGS  
QUEEN / EK SIDE RAILS

STEP 1 / ETAPE 1

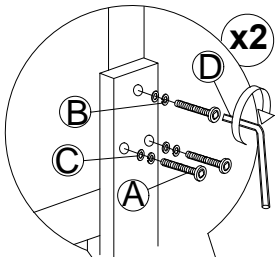

STEP 2 / ETAPE 2

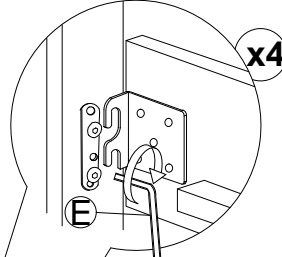

STEP 5 / ETAPE 5

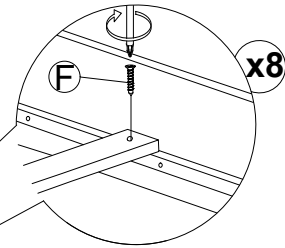

STEP 4 / ETAPE 4

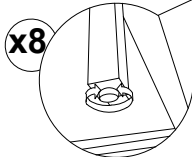

Note :- Adjust leveller to stabilize /  
Remarque: Ajustez le niveleur pour  
stabiliser

STEP 3 / ETAPE 3

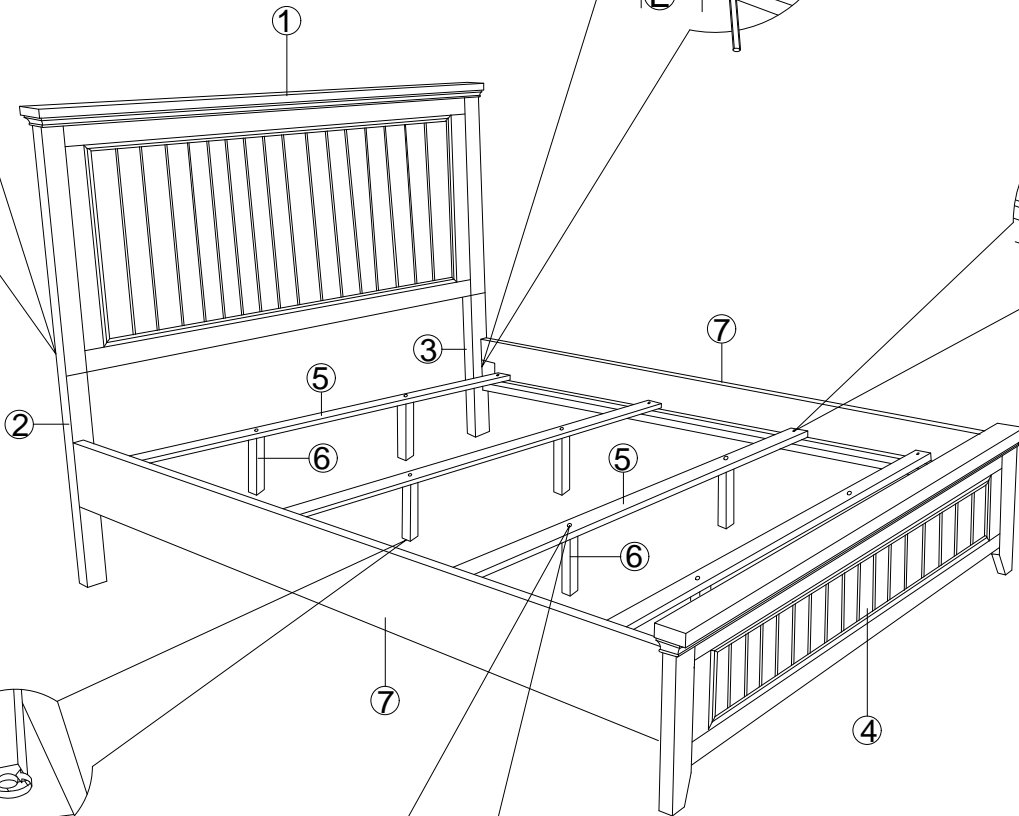
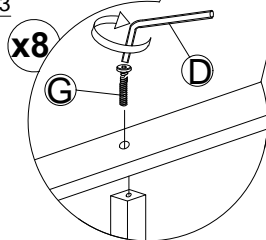

DO NOT TIGHTEN BOLTS UNTIL COMPLETELY ASSEMBLED.  
NE PAS SERRER LES BOULONS JUSQU'A CE QUE LE MONTAGE SOIT COMPLETMENT