

Purchase Date: ___ / ___ / ___ Order/Customer Reference Number: _____

We stand behind our brand and the quality of the items we sell. Replacement parts or products can be requested within the 1-year warranty period. Proof of purchase must be provided. This includes the date of the purchase as well as photos of the product defect. Photos are used to determine the cause of the defect and to provide future quality control. The request will be reviewed, and replacement pieces will be sent at our discretion.

DESERT SPRING SOLAR WATER FOUNTAIN

Review all assembly and care information before using this product. Save this manual for future reference.

Select a smooth, level surface to place the fountain.

Assemble components on a soft, clean surface to avoid scratching or damaging the finish.

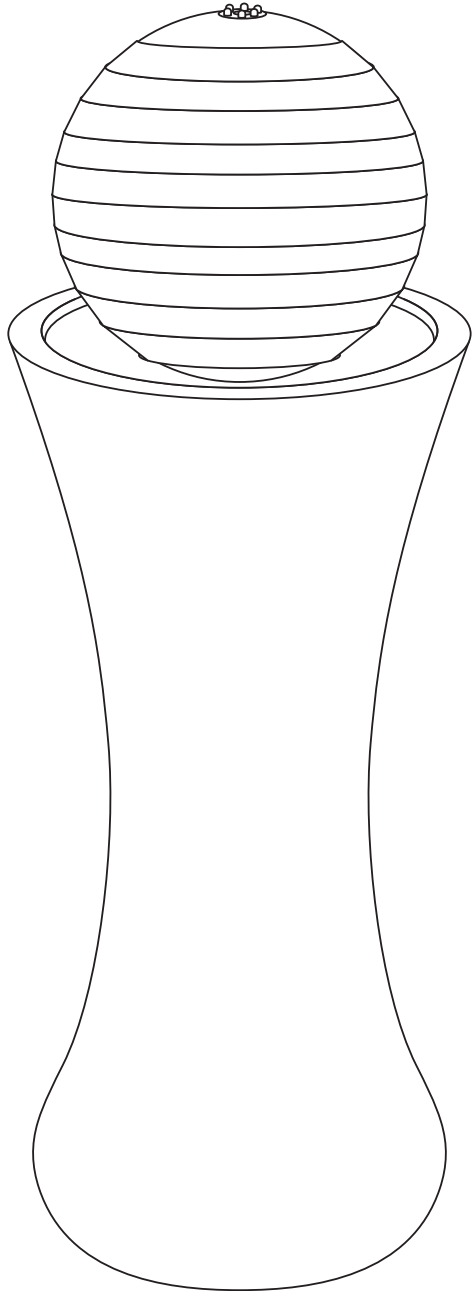

Inspect packaging to ensure all parts are accounted for before disposing of packing materials.
Save the packing slip.

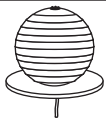
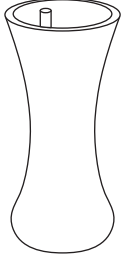
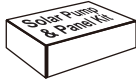
PARTS		QTY.
	Topper	1
	Pedestal	1
	Solar Pump & Panel Kit	1



Quiet, trickling water sounds



IMPORTANT NOTES:

- The water tubing is built into the fountain topper. Take care when handling the water tube; detaching the water tube from the fountain will damage the unit and void the warranty.
- Do not use a high-pressure spray nozzle to fill the fountain as doing so may cause the paint to peel.
- Rattling noise inside the fountain? Due to the casting process, there may be loose pieces of casting material inside the fountain.

WARNING:

Manufacturer and seller expressly disclaim any and all liability from personal injury, property damage or loss, whether direct or indirect, or incidental, resulting from the incorrect attachment, improper use, inadequate maintenance, or neglect of this product.

ASSEMBLY

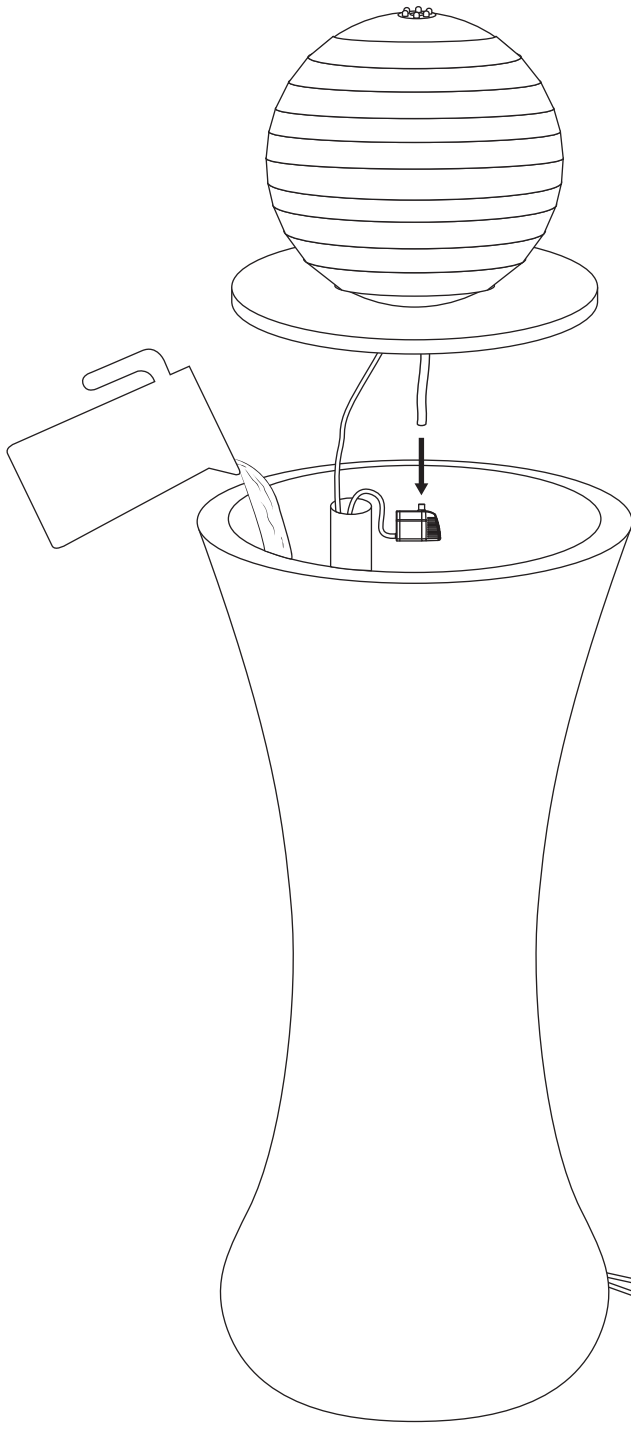

1. Place the pump in the basin. Run the power cord through the tube in the basin and out through the groove in the bottom of the pedestal.
2. Taking care not to drop the fountain topper, run the LED light cable through the tube in the basin and out through the groove in the bottom of the pedestal.
3. Firmly connect the water tube to the pump and place the topper in the basin.
4. Fill the basin with enough water to keep the pump fully submerged during operation, approximately 1.5 gallons (5.7L).
5. If the battery pack is not already installed into the solar panel, install the battery pack; refer to page 3.
6. Identify the ports on the back of the solar panel. Plug the pump cable into the 'pump' port and the light cable into the 'light' port.
7. Ensuring the solar panel is positioned for maximum sun exposure, assemble the solar panel ground stake and insert the spike into the ground.

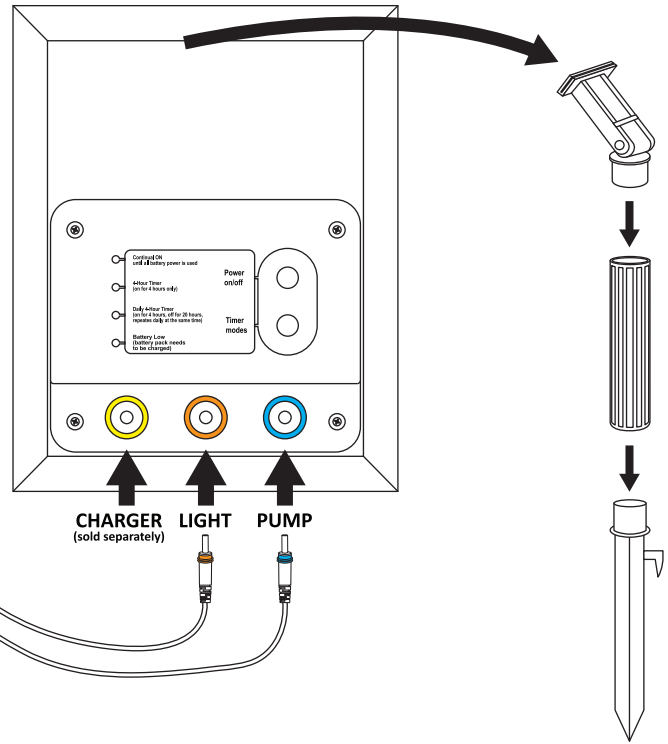

PANEL PLACEMENT

Insert the spike into the ground. Position the solar panel so it is facing south (in the Northern Hemisphere), doing so will make the most of daylight hours. It is important to angle the solar panel towards the sun when the sun is at its highest point to help ensure the battery pack charges properly. It is also important that trees, shrubs, or buildings do not shade the solar panel at any point during the day.

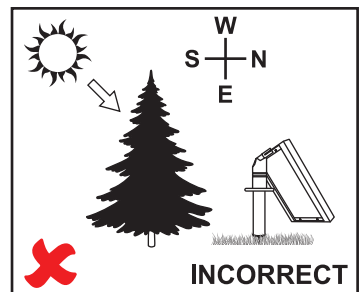
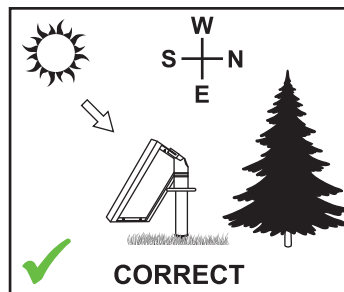

SOLAR PANEL OPERATION

NOTE: The LED light only works at night. Pump operation is reliant on the solar panel receiving full sunlight; see chart below.

Continual ON: Press the "Power on/off" button. The top indicator light [continual on] will be lit — the pump will run continuously until the battery power runs out. The pump will automatically restart when the solar panel battery has been sufficiently charged with sunlight. On bright sunny days, surplus power will charge the battery. The pump will not work on cloudy days as there is insufficient power to run the pump.





4-Hour Timer: Press [Timer modes] button until the second indicator light [4hrs Timer] is lit — the pump will run for 4 hours and stop. The pump will not run again until the solar panel is manually restarted.

Daily 4-Hour Timer: Press [Timer modes] button until the third indicator light [Daily 4hrs Timer] is lit — the pump will run for 4 hours and shut down (in standby) for 20 hours; this operation will repeat daily at the same time. You can reset the pump's daily start-up time by switching it on at a new desired time in this same mode. **NOTE:** The third indicator light will blink slowly when the pump has reached the 4-hour runtime and be in standby for the following 20 hours. To save battery power, the indicator light will automatically turn off. You can activate the indicator light to check its status with a single push of either button; the indicator light will be on for a while and shut off again.

Battery Low:

If the red indicator light is blinking, the battery power is low and the pump will stop running. The red indicator light will turn off after the solar panel receives enough sunlight for the battery to be recharged.

NOTE: This model allows for the battery pack to be charged with an original electric charger (sold separately). Only use an original battery charger as alternatives may damage the battery and will void the warranty. See contact information at the top of page 1 to order the compatible charger.

WEATHER	PUMP ON Surplus solar energy is charged to back-up battery pack	PUMP OFF All solar energy is charged to back-up battery pack
	Solar energy runs the pump and charges the battery. Pump performance is maintained when the clouds pass. Pump runs into the evening/night until the battery is depleted.	Battery should be fully charged in 1 day.
	Solar energy runs the pump and surplus energy is stored in the battery. Performance is maintained when the clouds pass. The pump will only run for a short time in the evening until the battery is depleted.	Battery will take 2 to 3 days to fully charge.
	Pump will only run when there is sufficient power from the battery. Little or no battery charging occurs so pump performance is not maintained or guaranteed.	Battery will take several days to fully charge.
	No solar power is available, the pump will not run and the battery will not charge.	Battery will not charge.

PUMP PERFORMANCE & MAINTENANCE

The performance of the pump depends on the orientation of the solar panel being toward the sun as well as sunlight strength;

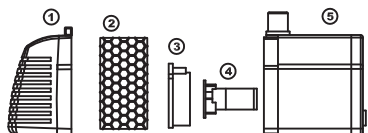

① FRONT CASE ② FILTER ③ IMPELLER COVER
④ IMPELLER ⑤ PUMP

pump performance is not guaranteed when the solar panel is in the shade or poor weather conditions. Max. Data is obtained during optimal conditions (refer to Technical Data); solar panel performance cannot be guaranteed if placed in the shade or during poor weather conditions. The performance of the pump also depends on the battery power level; the pump cannot operate if battery power is low.

This solar pump is designed to last for years if it is properly cleaned and maintained. If the pump starts losing power or stops working, clean the pump filter and impeller with clean water.

BATTERY INFORMATION & REPLACEMENT

Rechargeable batteries become less efficient with repeated charge and discharge cycles. If you find the batteries appear to be less efficient or do not run as long, try a **boost charge**. To do this, disconnect the pump and light cables from the solar panel for 2 to 3 sunny days to allow for a maximum charge to the batteries. After a boost charge, if the batteries are still not performing to expectations, the lifespan may have been exceeded and they should be replaced. Open the battery cover to replace the battery pack.

IMPORTANT! Only use a compatible rechargeable battery pack, alternatives may be incompatible which can damage the system and will void the warranty. See contact information at the top of page 1 to order the correct replacement pack; have the product number from the top of this manual available for faster service.

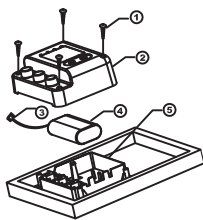

- ▶ Remove Screws ① from Control Panel Cover ② using a Phillips screwdriver.
- ▶ Disconnect the Battery Pack Connector ③, and remove the Battery Pack ④ from Control Panel Base ⑤.
- ▶ Connect the new battery pack connector to the control panel base and insert the battery.
- ▶ Replace the panel cover and tighten the screws.

Dispose of the batteries in accordance with local laws and regulations.

CARE & MAINTENANCE

Some climates and weather conditions increase water evaporation, requiring water to be added more frequently. Check water levels during times of high temperatures, wind, and long-term exposure to direct sunlight to ensure the pump remains underwater. The pump is equipped with dry-run technology, the pump will shut off when water is low or runs out.

Only use water in this fountain. Distilled water will help prevent mineral buildup but is not required. Tap water is okay to use, but avoid heavily chlorinated water as it may damage the fountain finish and the pump.

Over time, the finish may gradually mellow in color due to sun exposure; this is part of the natural aging process and is not cause for return.

Periodically change the water to help keep the fountain and pump clean. Remove scale and buildup regularly.

DO NOT use harmful additives such as bleach, chlorine, etc.

DO NOT use anything that is abrasive to scrub the fountain.

DO NOT use a pressure washer to clean the fountain.

Always disconnect the power supply before cleaning and maintaining the fountain and the circulating pump. Take care when handling the pump; only pick it up by the body of the pump, never the power cable.

During freezing weather, drain the fountain, disconnect the pump and panel. Store indoors; allowing ice to form may damage the fountain in such ways as, but not limited to, fountain cracking, permanent pump and/or solar panel damage.

The optimal temperature for lithium batteries is 50°F to 113°F (10°C - 45°C), do not use the product beyond this temperature range.

IMPORTANT: Fully charge the battery before storing. Over time, battery power discharges, so if it is stored at no charge, there is a chance it won't accept a charge again. To avoid this problem, disconnect the pump and leave the solar panel in direct sunlight for 1 or 2 days to ensure the battery has been recharged.

WARNING: THE ONE-YEAR WARRANTY DOES NOT COVER DAMAGES OR DEFECTS CAUSED BY THE APPLICATION OF CHEMICAL TREATMENTS, PROTECTIVE COATINGS, TOUCH-UP PAINT, OR CLEANING PRODUCTS.

TROUBLESHOOTING

- The solar panel must be in a location that receives full sunlight; the pump will not operate if the panel is shaded and the back-up battery is depleted. If the solar panel does not receive the proper amount of full sunlight daily, a suitable electric charger (sold separately) may be required to help extend operating time.
- Check the power cable to make sure it is fully inserted into the correct port on the solar panel.
- Ensure that the pump is fully submerged in water. The pump is equipped with dry-run technology, it will not circulate water unless the pump is completely covered with water. If water is still not flowing, air may be trapped in the pump, gently tap the pump to release the trapped air.
- Check the pump and fountain tubing for obstructions.
- If the light is not working at night, ensure the cable is properly connected to the correct port on the solar panel. Additionally, ensure the solar panel is not receiving too much ambient light.

TECHNICAL DATA

MAX. PUMP WATER FLOW: 250LPH
MAX. PUMP WATER LIFT: 90 cm
PUMP WORKING VOLTAGE: DC8.4V~DC6.5V
PUMP WORKING POWER: 1.2W~0.6W
PROTECTION GRADE OF PUMP: IP68

SOLAR PANEL: 5W-9V-0.555A
SOLAR PANEL SIZE: 190 x 250 x 18 mm
PROTECTION GRADE OF PANEL: IP44
LI-ION BATTERY PACK: 7.4V/1.5Ah
PROTECTION GRADE OF BATTERY BOX: IP44

LED LIGHT WORKING VOLTAGE: DC7.4V
LED LIGHT WORKING POWER: 0.15W
PROTECTION GRADE OF LED LIGHT: IP68

! SAFETY STATEMENTS & WARNINGS !

- For outdoor use only.
- Fountains may splash or leak; always protect surfaces that can be damaged by water.
- Do not use high-pressure spray nozzles to fill the fountain as doing so may cause the finish to peel.
- Keep fountain out of reach of children and pets.
- Make sure the power cable is away from traffic areas.
- Keep power cables away from all heat sources. Do not place power cables near high-temperature areas.
- Always unplug the power supply before cleaning and maintaining the fountain and the pump.
- Always empty and store the fountain, pump, and solar panel indoors during freezing weather.

 This product uses rechargeable batteries. When the batteries can no longer be used, they should be removed from the unit and recycled. The batteries must not be incinerated or composted. Recycle batteries in accordance with local laws and regulations.

Any modification to the product or failure to follow recommended care will void the product warranty.

If you experience issues with assembly or the product was damaged during transit, please contact our customer service team through one of the methods mentioned at the top of page 1. Please have the item number and order information ready to expedite response time.

! WARNING:

Manufacturer and seller expressly disclaim any and all liability from personal injury, property damage or loss, whether direct or indirect, or incidental, resulting from the incorrect attachment, improper use, inadequate maintenance, or neglect of this product.