

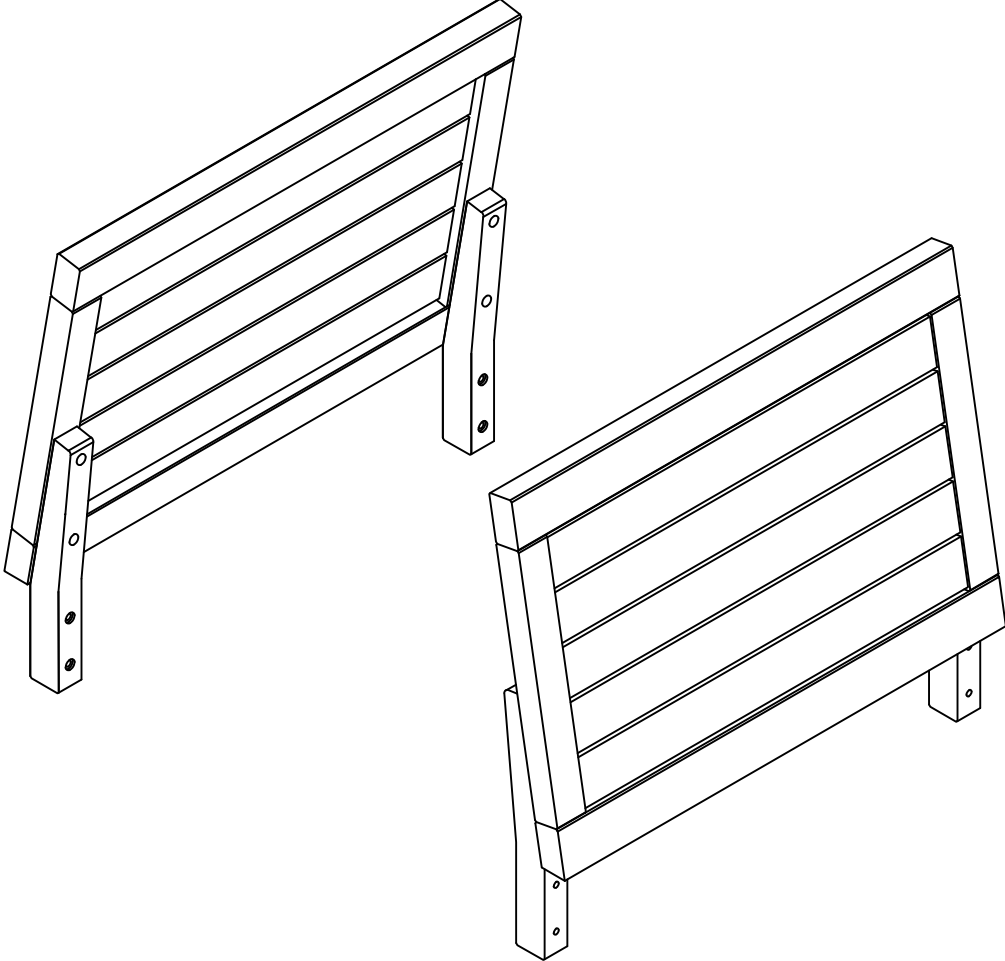

ASSEMBLY INSTRUCTIONS

BACK

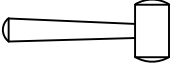
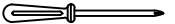
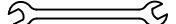

Tools Required (Not Included)

				
Rubber Hammer	Phillips Screwdriver	Wrench	Cordless Drive (*)	

(*) NOTE: Optional - use in place of hex drive.

Identifying the Hardware-Identify the hardware using the illustrations below.

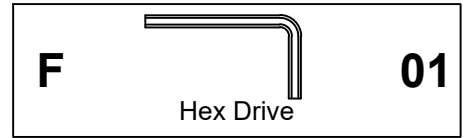
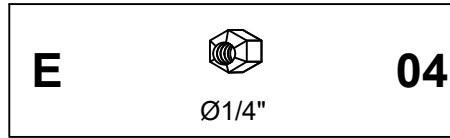
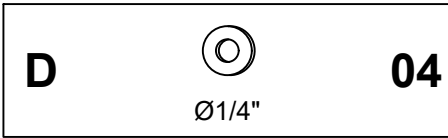
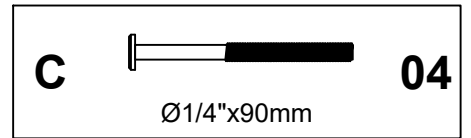
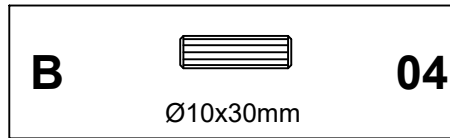
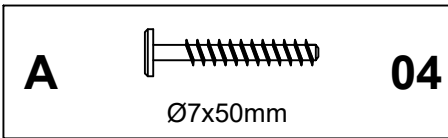

01

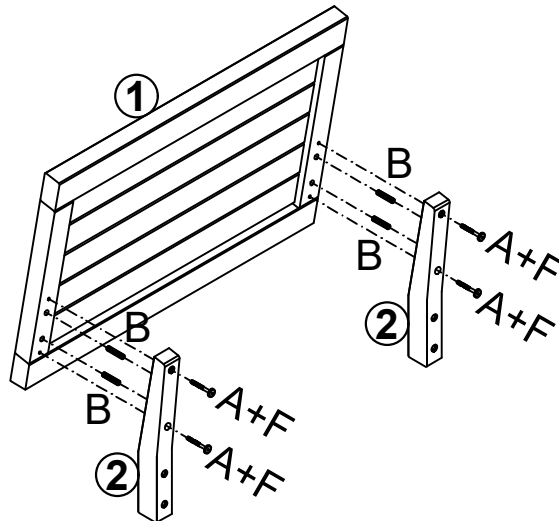
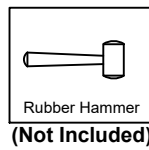
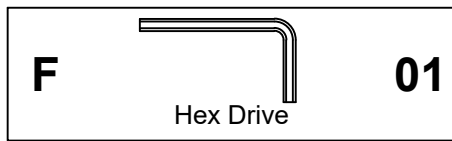
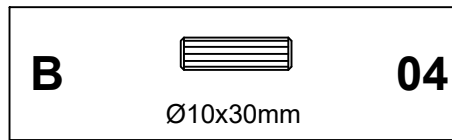
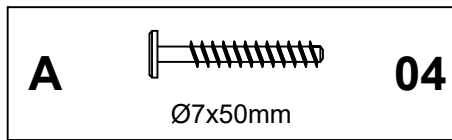

02

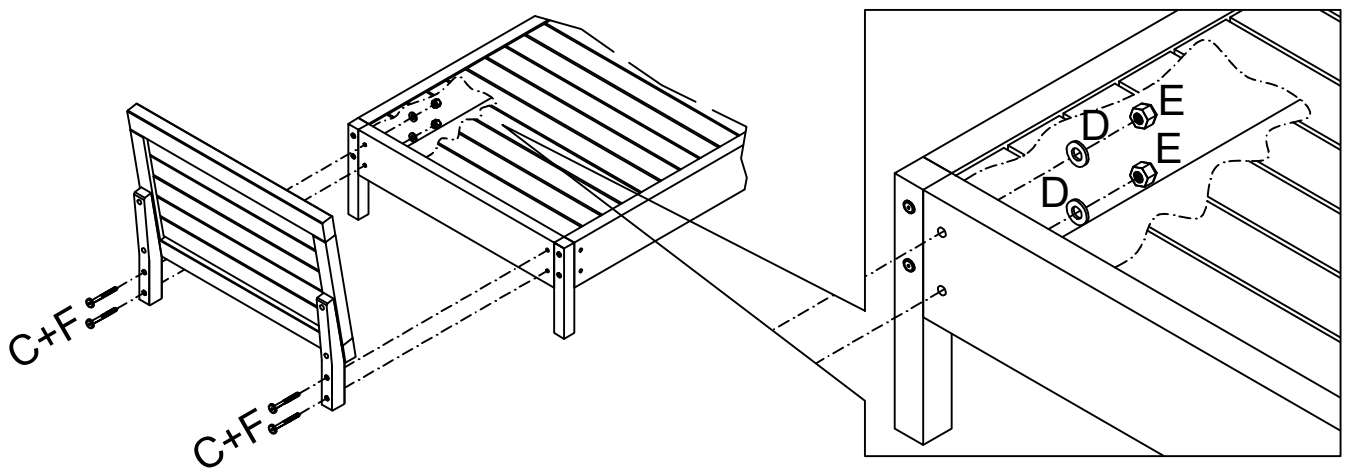
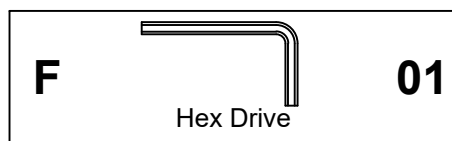
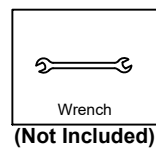
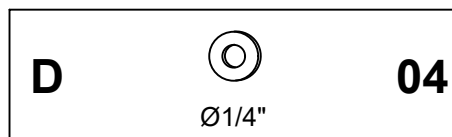
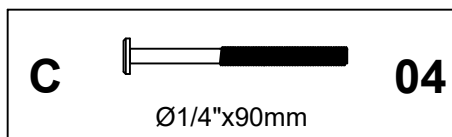

ASSEMBLY INSTRUCTIONS

SINGLE CHAIR

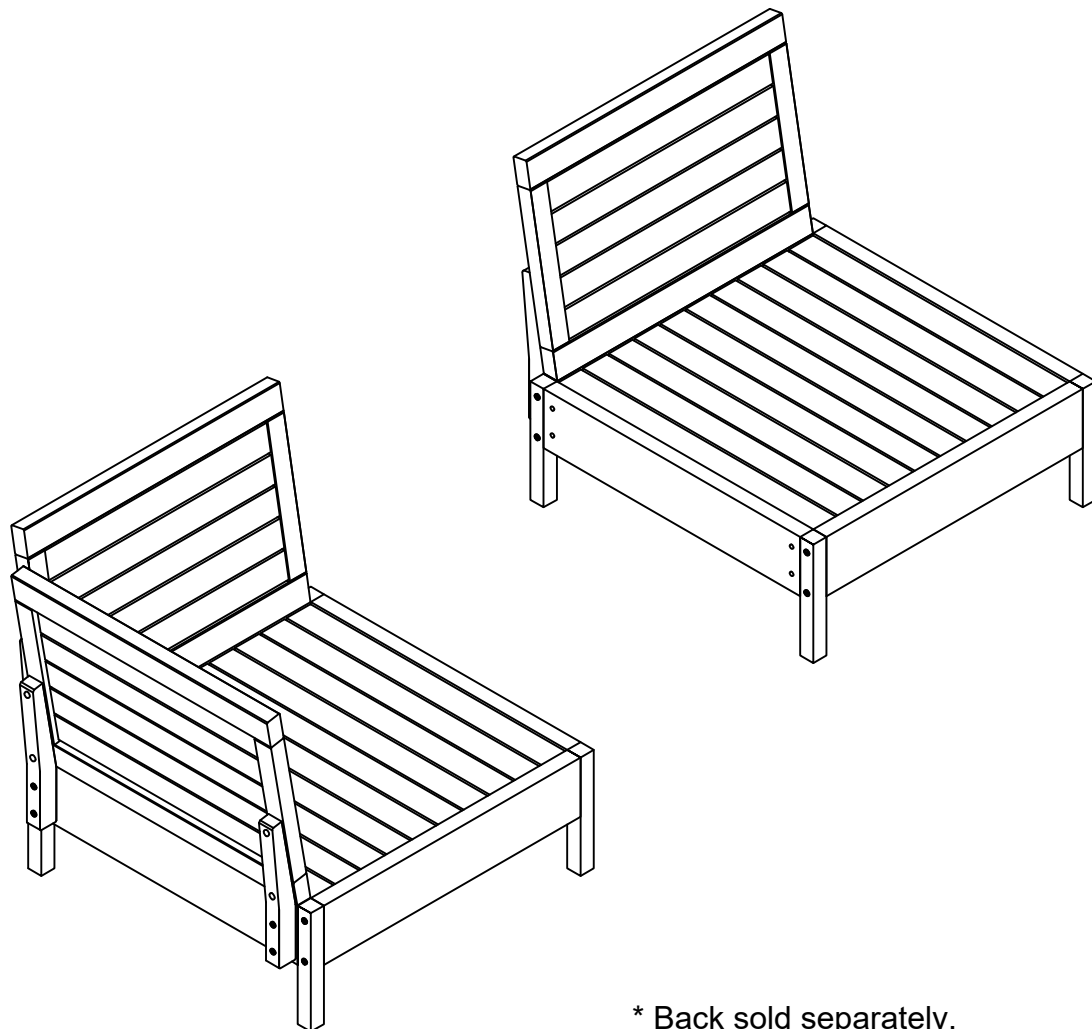

* Back sold separately.

Tools Required (Not Included)

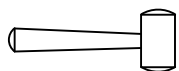

Rubber Hammer

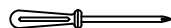

Phillips Screwdriver

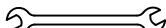

Wrench



Cordless Drive (*)



(*) NOTE: Optional - use in place of hex drive.

Identifying the Hardware-Identify the hardware using the illustrations below.

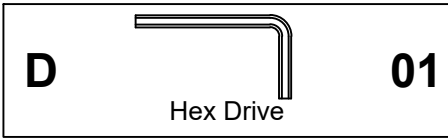
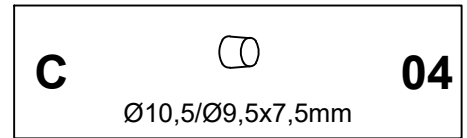
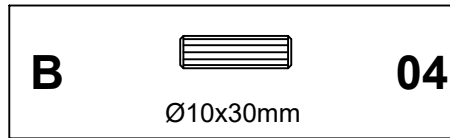
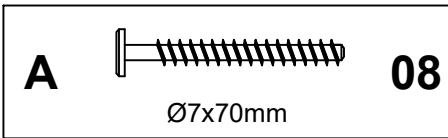

01

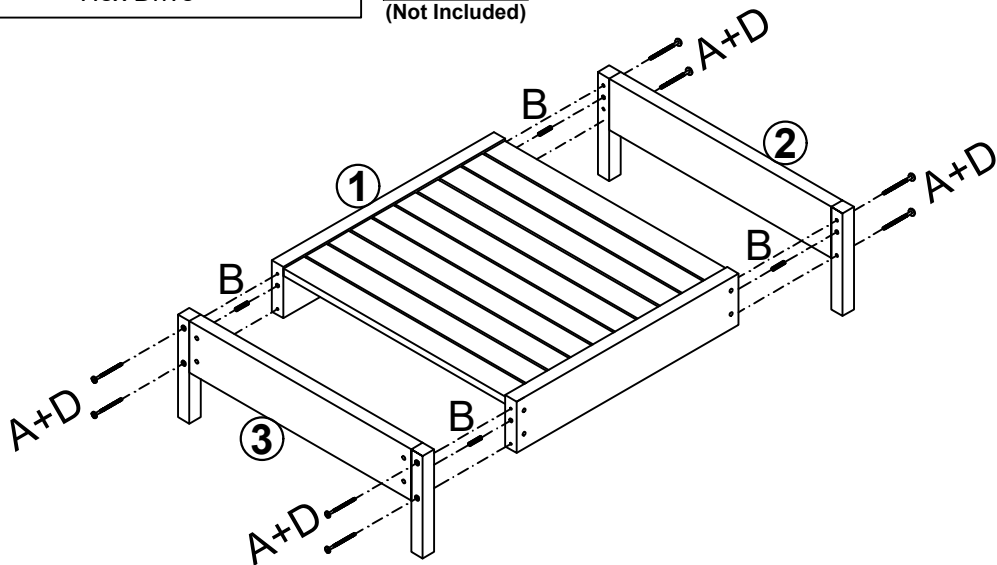
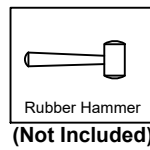
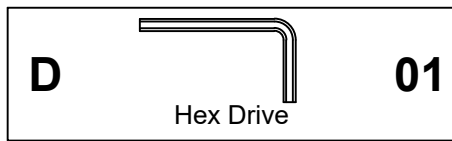
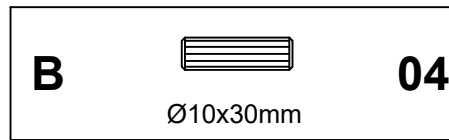
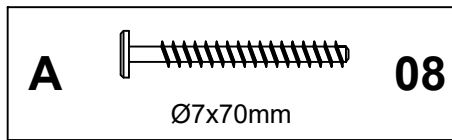

02

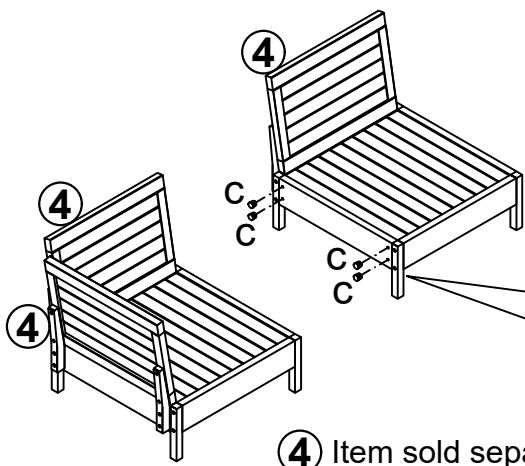
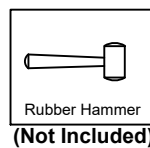
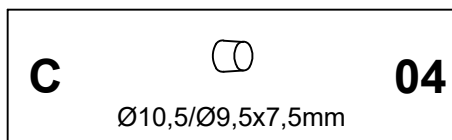

4 Item sold separately.

