

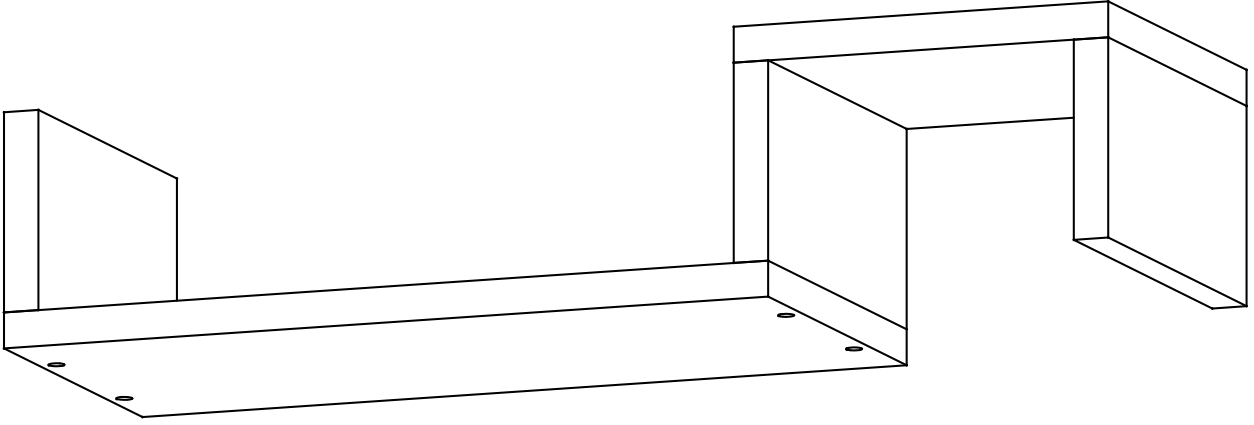





WALL SHELF

ASSEMBLY MANUAL

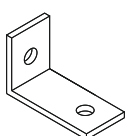

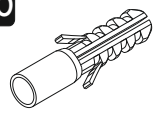
ACCESSORY LIST / AKSESUAR LİSTESİ

| | | | | |
|-----------------------------------------------------------------------------------------------------------------|---------------------------------------------------------------------------------------------------------------|-----------------------------------------------------------------------------------------------------------------|-------------------------------------------------------------------------------------------------------------------|---------------------------------------------------------------------------------------------------------------------|
| A17  4x50 8x | A15  LA 3x | A10  14mm 8x | A42  5x70 3x | A16  DB 8mm 3x |
| GENERAL VIEW / PARÇA KODLAMA | | | | A18  3,5x18 3x |

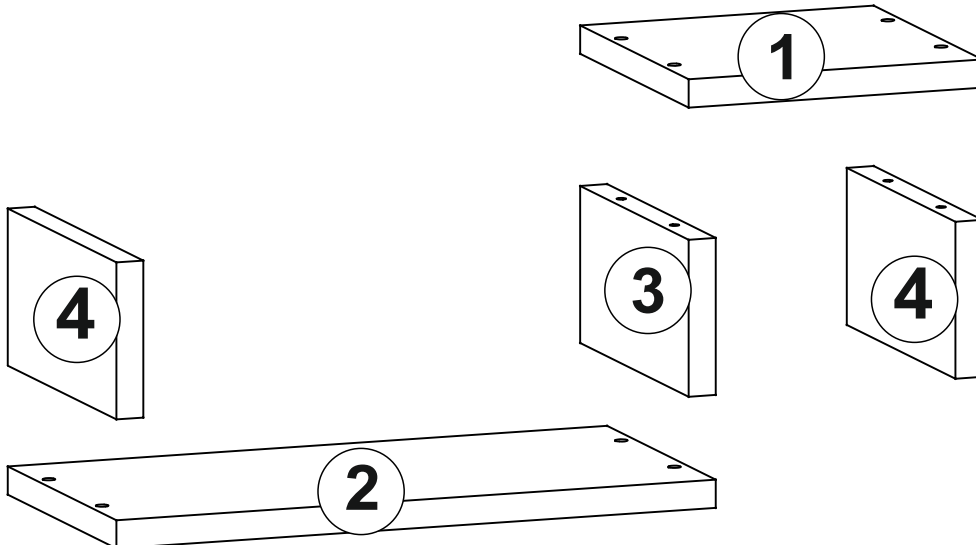

1

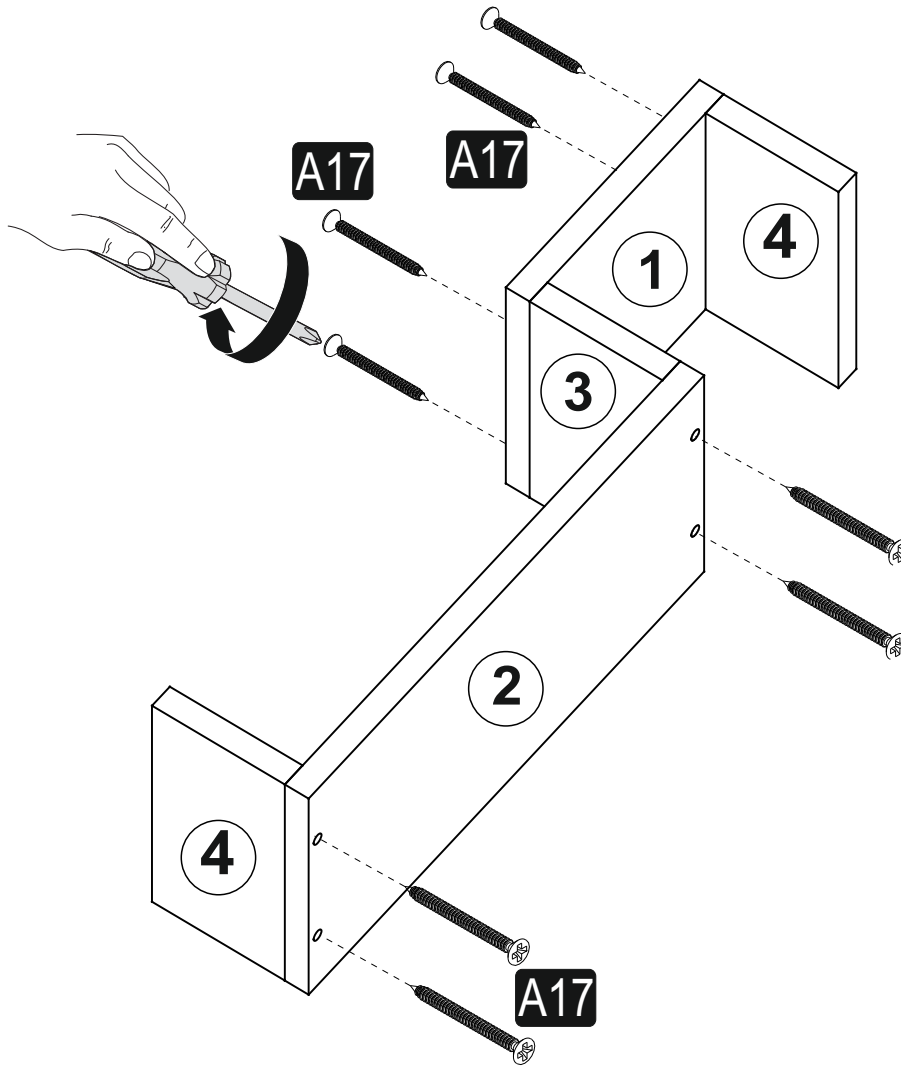

2

