

ASSEMBLING INSTRUCTION

AX1PC



B X2PCS



C X2PCS



D X14PCS



M6*25

E X1PC



F X4PCS



1

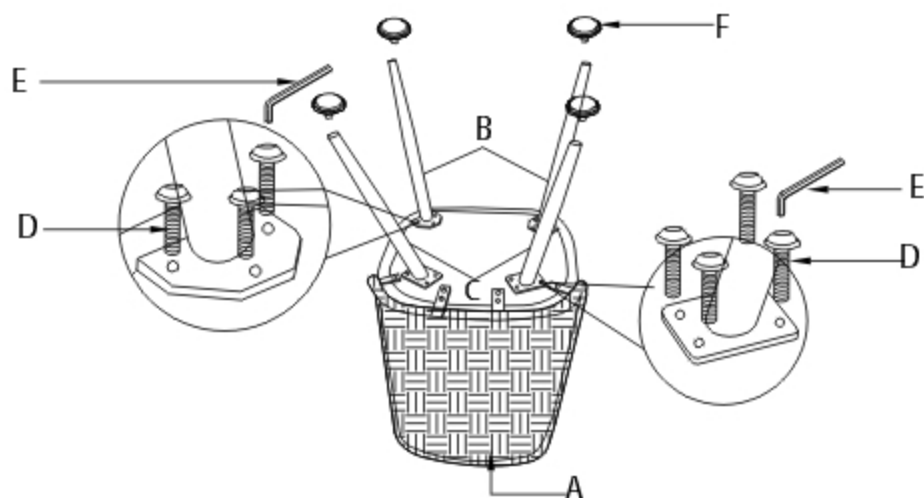

2

