

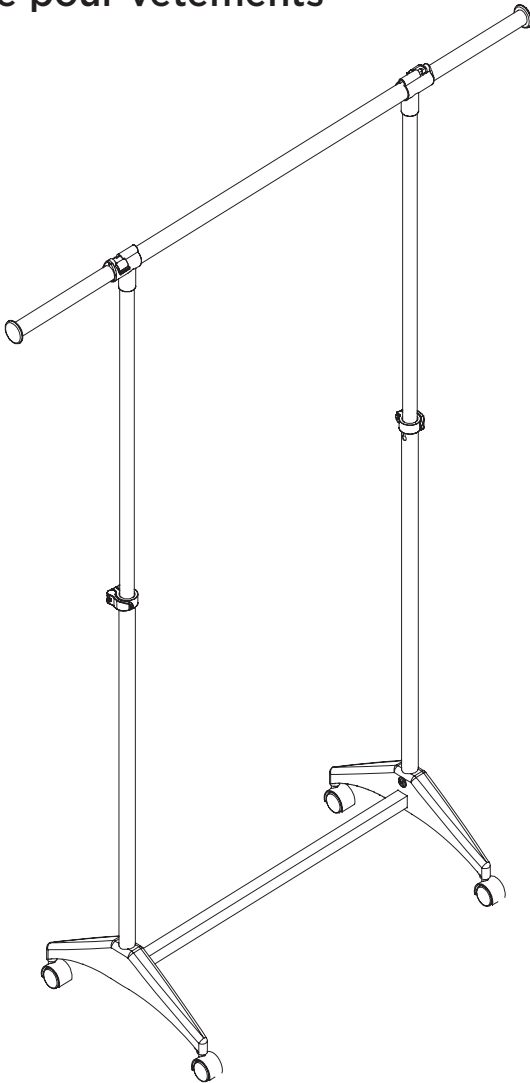









garment rack
estante para prendas
étagère pour vêtements

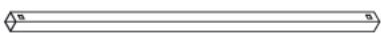

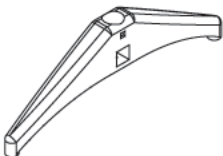



54.92 in L x 16.93 in W x 66.93 in H (139.5 cm L x 43 cm W x 170 cm H)

PARTS LIST

PART/ILLUSTRATION	(QTY)	DESCRIPTION
A 	(1)	hanging bar barra de colgar barre de suspension
B 	(2)	lower vertical vertical inferior verticale inférieure
C 	(2)	upper vertical vertical superior verticale supérieure
D 	(1)	base horizontal horizontal de base base horizontale
E 	(2)	upper extenders extensores superiores rallonges supérieures
F 	(2)	base el pie la pied
G 	(2)	casters ruedas roulettes
H 	(2)	locking casters ruedas de bloqueo roulettes à blocage
I 	(4)	base screw tornillo de la base vis de base

PARTS LIST

PART/ILLUSTRATION		(QTY)	DESCRIPTION
J		(1)	left adjustment piece ajuste izquierda ajustement gauche
K		(1)	right adjustment piece ajuste derecha ajustement droit
L		(1)	hex wrench llave hexagonal clé hexagonale
M		(2)	end cap tapa de extremo embout
N		(2)	connector conector connecteur

TOOLS NOT INCLUDED

O		phillips screwdriver destornillador philips philips tournevis
---	---	---

ASSEMBLY

1

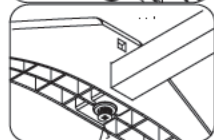
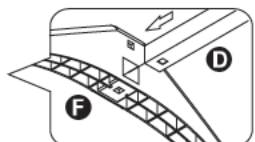
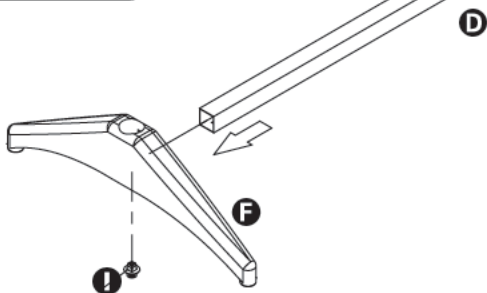
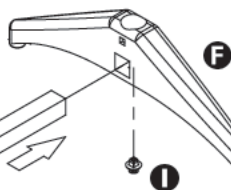
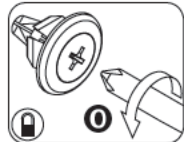
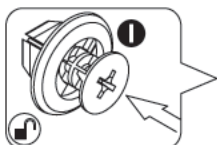
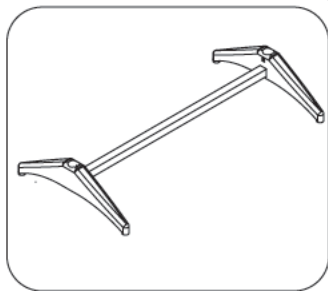

ASSEMBLY

2

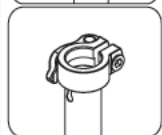
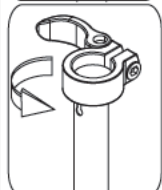
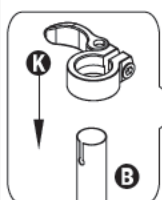

B

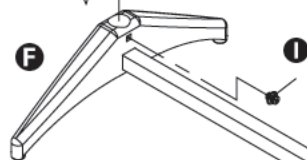

K

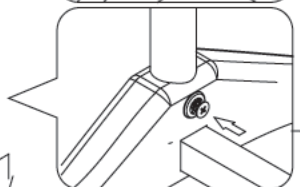
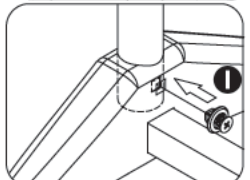
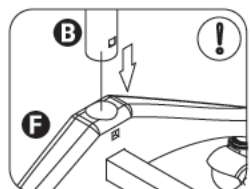
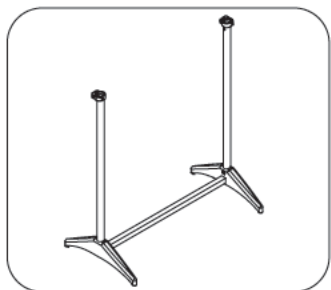
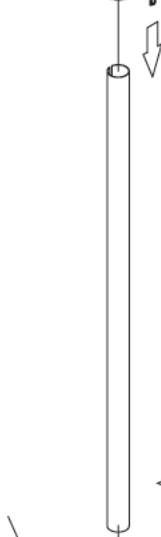

ASSEMBLY

3

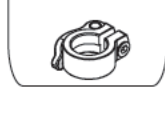
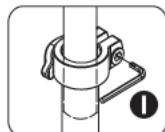
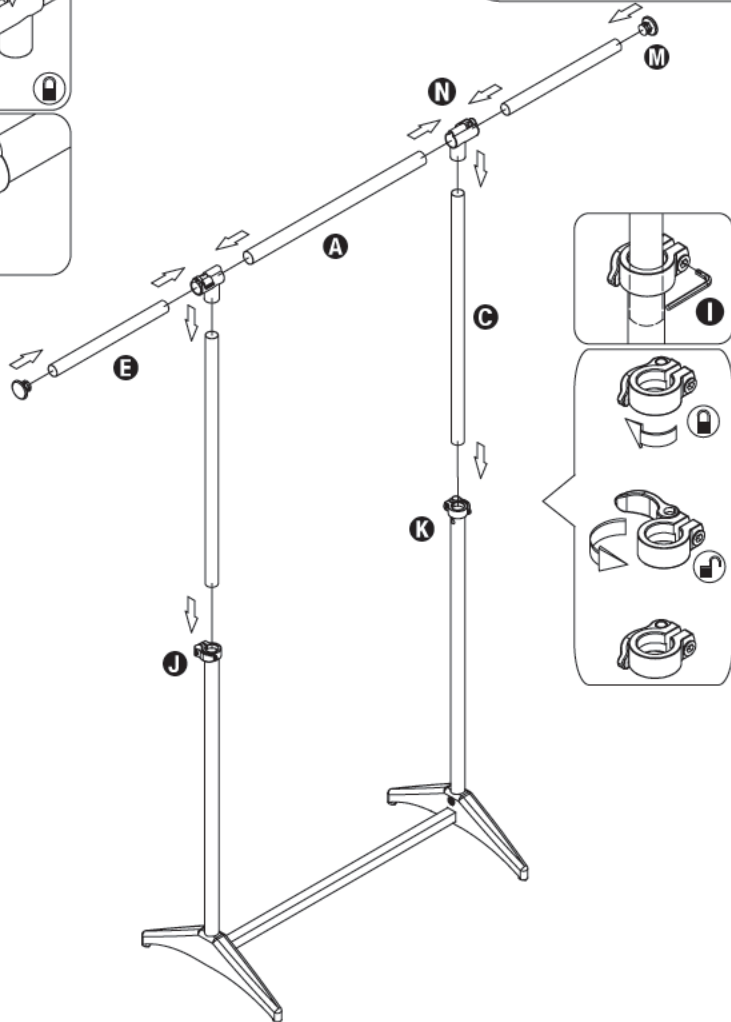
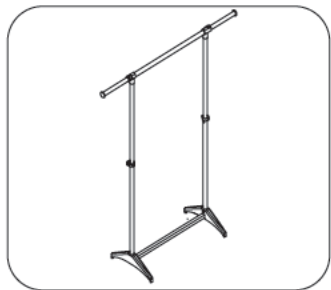
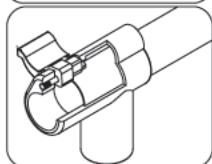
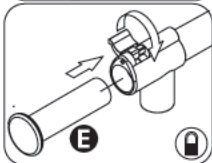
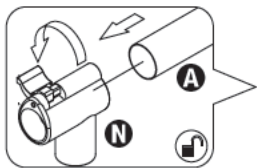

ASSEMBLY

4

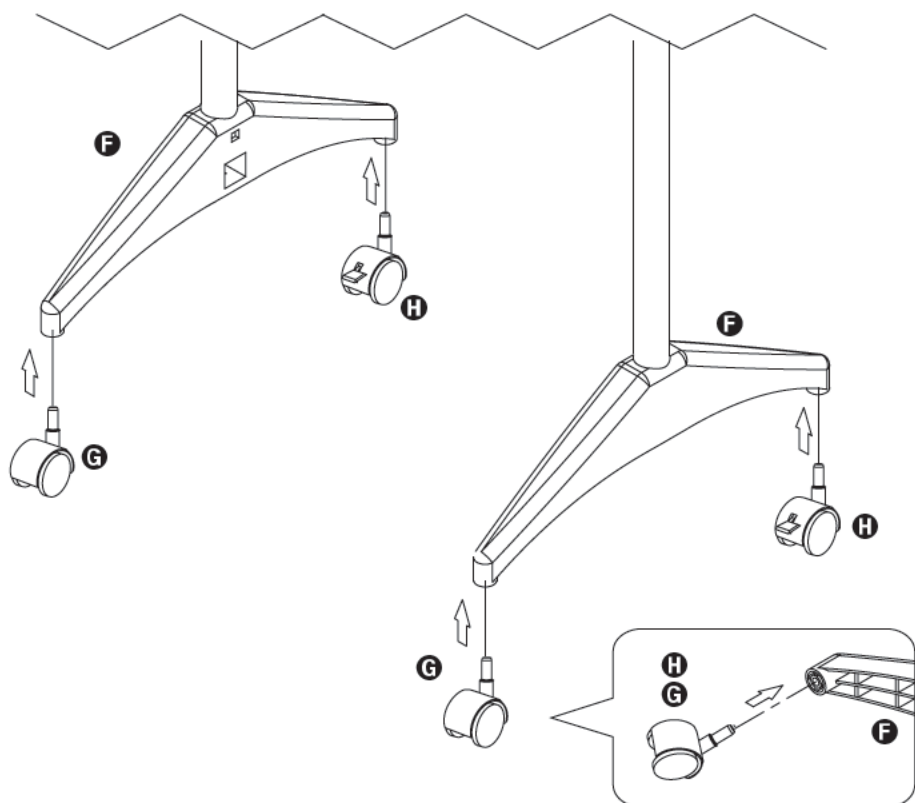

LIMITED LIFETIME WARRANTY

Our warrants its products will be free from defects in materials and workmanship when used for normal personal or household use. Except as provided below, , at its op-tion, may offer a comparable product or offer a replacement part or request that the item be returned to the place of purchase. This warranty DOES NOT apply to damage caused by negligence, misuse, excessive use, improper cleaning, improper assembly, or any circumstances not directly attributable to manufacturing defects. Proof of purchase is required in the form of a receipt (copy or original) to validate warranty. provides this limited lifetime warranty in lieu of all other warranties, either express or implied. In no event shall , its affiliates, or subsidiaries be responsible for consequential or incidental damages arising out of a claim of defective product. Some states or provinces do not allow some exclusions or limitations, so the above statement may not apply to you. This warranty gives you specific legal rights. Additional rights vary by state or province.

WARNING:

Keep bags and plastic sheeting away from babies and children. Do not use in cribs, beds, carriages or play-pens. The plastic may cling to the nose and mouth and prevent breathing.

GARANTÍA LIMITADA DE POR VIDA

Garantiza que sus productos estarán libres de defectos en los materiales y mano de obra cuando se utilice para su uso personal o doméstico normal. Salvo lo dispuesto a continuación, a su discreción, puede ofrecer un producto similar u ofrecer una pieza de repuesto o solicitar que el artículo sea devuelto al lugar de compra. Esta garantía NO se aplica a los daños causados por negligencia, mal uso, uso excesivo, limpieza inadecuada, montaje incorrecto, o cualquier otra circunstancia no directamente atribuible a defectos de fabricación. Se requiere el comprobante de compra en la forma de un recibo (copia u original) para validar la garantía. ofrece esta garantía limitada de por vida, en lugar de cualquier otra garantía, ya sea explícita o implícita. En ningún caso, , sus afiliados o filiales serán responsables de daños directos o indirectos resultantes de una reclamación por producto defectuoso. Algunos estados o provincias no permiten algunas exclusiones o limitaciones, por lo que la afirmación anterior podría no ser aplicable a usted. Esta garantía le otorga derechos legales específicos. Derechos adicionales varían de acuerdo al estado o provincia.

ADVERTENCIA:

Mantenga las bolsas y láminas de plástico fuera del alcance de los niños y los bebés. No debe usarse en cunas, camas, carritos o corrales de juego. El plástico puede adherirse a la nariz y boca y provocar asfixia.

GARANTIE À VIE LIMITÉE

Garantit que ses produits sont exempts de défauts de matériaux et de fabrication lorsqu'ils sont utilisés pour un usage personnel ou ménager standard. Sous réserve des dispositions ci-dessous, à sa discrétion, peut proposer un produit comparable ou offrir une pièce de rechange ou demander que l'article soit renvoyé à l'endroit de l'achat. La présente garantie ne s'applique pas aux dommages causés par négligence, abus, utilisation excessive, mauvais nettoyage, montage incorrect ou toute autre circonstance qui ne serait pas directement attribuables à des défauts de fabrication. Une preuve d'achat est nécessaire sous la forme d'un reçu (copie ou original) pour la validation de la garantie. La présente garantie à vie limitée fournie par HDC remplace toutes les autres garanties, qu'elles soient expresses ou implicites. En aucun cas, ses sociétés affiliées ou ses filiales ne peuvent être tenus responsables des dommages indirects ou accessoires issus d'une réclamation pour un produit défectueux. Certains états ou provinces ne permettant pas l'exclusion ni la restriction, la déclaration susmentionnée peut, en conséquence, ne pas vous concerner. La présente garantie vous confère des droits spécifiques. Les droits supplémentaires varient d'un état ou d'une province à l'autre.

AVERTISSEMENT:

Garder les sacs et les bâches en plastique à l'écart des bébés et des enfants. Ne pas utiliser dans des berceaux, des lits, des voitures ou des parcs de jeu. Le plastique peut s'accrocher au nez et à la bouche et empêcher la respiration.