

RATTAN ROCKING CHAIR

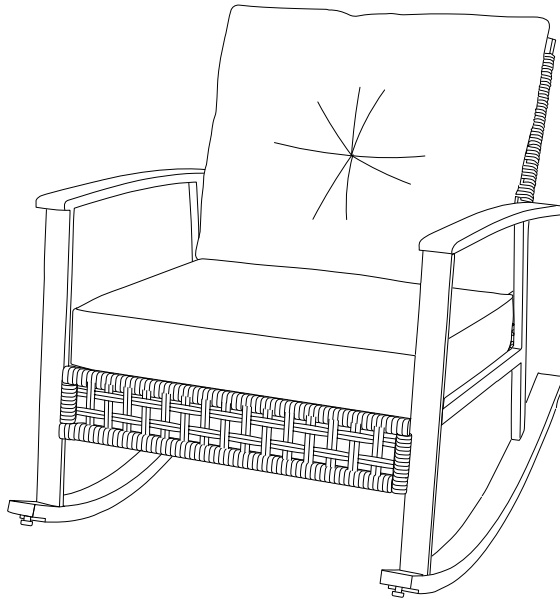

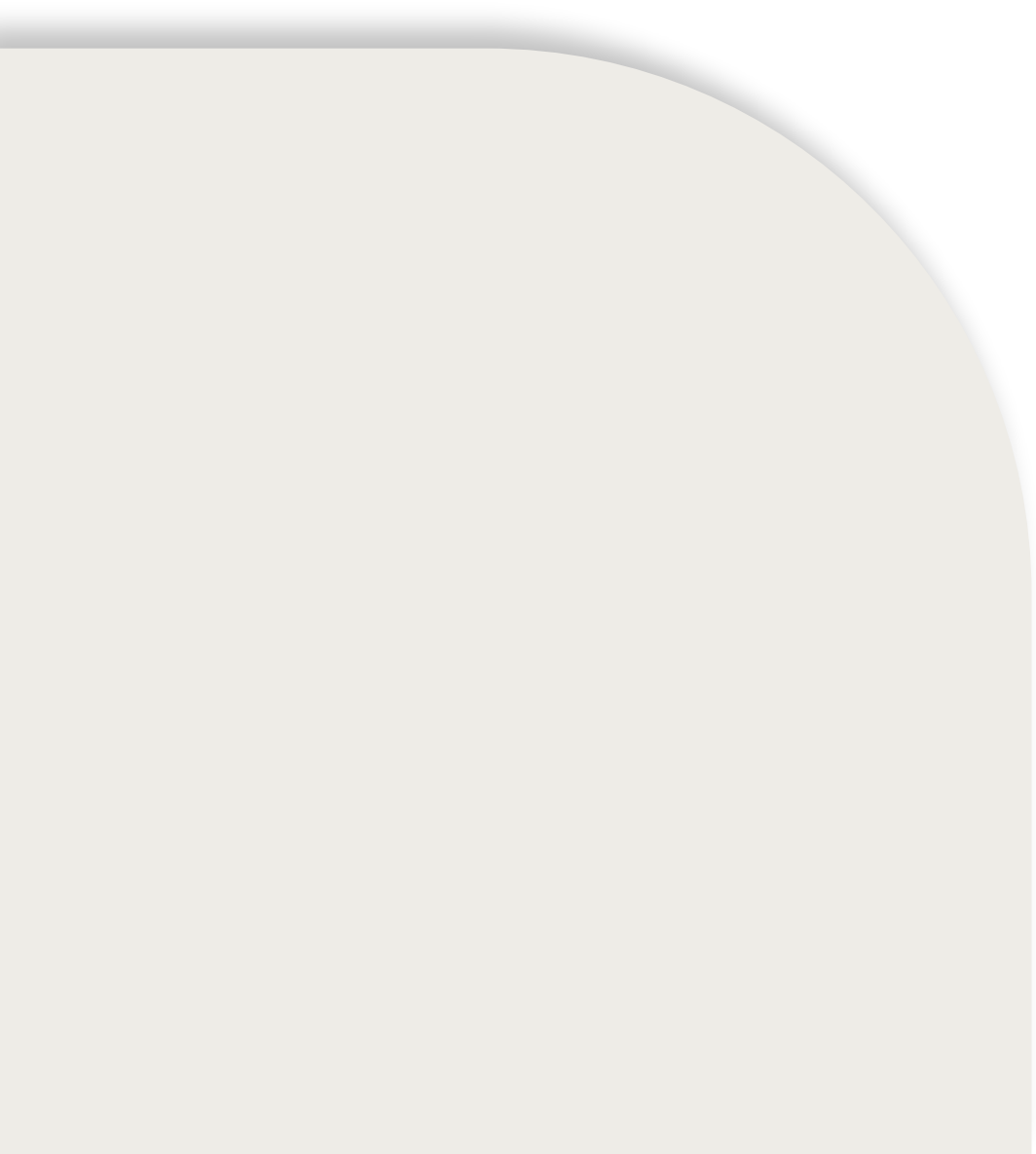

⚠ NOTICE

- Ensure the parts and quantities in the parcel are in accordance with COMPONENT LIST.
If there are any mistakes, please kindly contact us through the purchase platform.
- Do not firmly tighten the screws until the item is completely assembled.
- Be aware that some parts are heavy and have sharp edges.
- Please finish the installation on carpet or soft fabric.

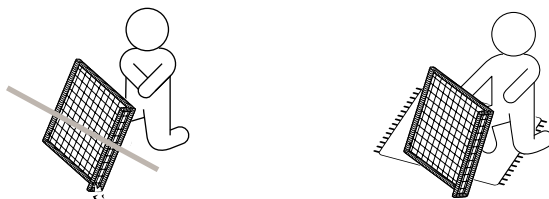

- If you have trouble in installing the product, feel free to contact us via customerservice@lausaint.com

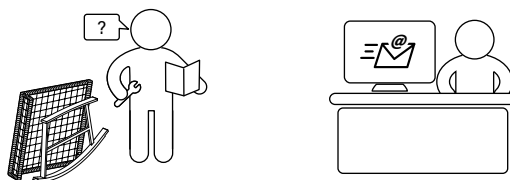

📖 TIPS FOR CUSHIONS

To compress the package, we put the cushions in the gap of some parts. So there may be crinkles on the fabric. Don't worry. Just flap every corner of the cushion evenly and it will get back into its original shape soon.

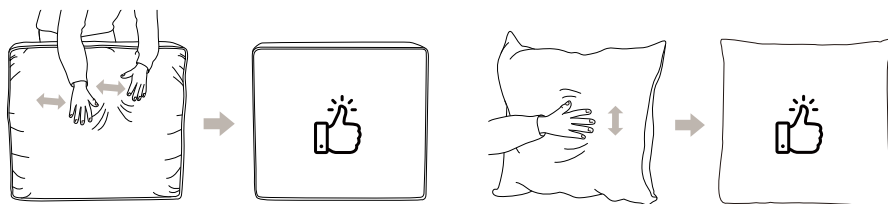

CARE & MAINTENANCE

- Inspect and tighten all bolts and fasteners on a regular basis to ensure the proper performance and safety of your product.
- Wash all frames with a solution of mild soap and water. Rinse with clean water and dry with a soft, absorbent cloth towel.
- Always place your patio furniture away from fire, extreme heat, freezing conditions, and inclement weather such as rain, hail, sleet, snow or wind.

WARRANTY GUIDELINES

- This warranty runs for one year from the date your product is installed.
- If this product or any associated parts are found to be defective or missing at the time of receipt, Lausaint Home will repair or replace, at its option, the defective parts at no charge to the original purchaser.
- Continuous free technical support is provided, including online diagnosis and troubleshooting of users' problems, and coming up with solutions in time.
In order to process your claim, please offer your order information along with AT LEAST 2 photos of the issue/damaged parts.

What is not covered by this limited warranty?

- Consumer misuse is not covered.
- Failure to follow recommended care will void the product warranty.
- Manufacturing defects only.
- Normal wear and tear not covered.
- Third-party labor or installation fees.

RETURN POLICY

- Return is available if you are unsatisfied with the product or bought the wrong item within 1 month of receiving the item. The item should be returned in its original unused condition and the original packaging.
Refunds typically take 2 business days after we have received and inspected your returned order.
- Please contact the purchase platform or email us at customerservice@lausaint.com if you have any questions.



Component List — Rocking Chair

DO NOT FULLY TIGHTEN ALL SCREWS UNTIL ASSEMBLY IS COMPLETED.

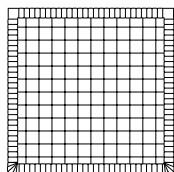

A x 1

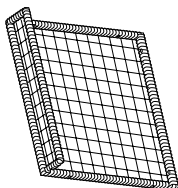

B x 1

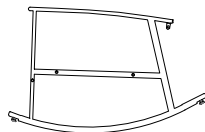

C x 1

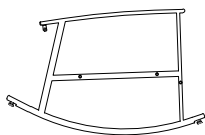

D x 1

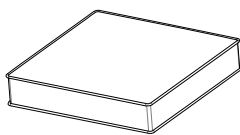

H x 1

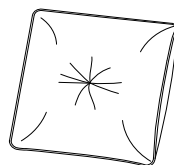

J x 1



G x (2 + 1)
(M6 X 20mm)



F x (8 + 1)
(M6 X 30mm)



S x 1



Rocking Chair Installation

1

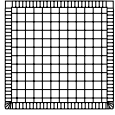

A

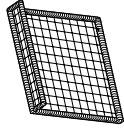

B

 M6 X 30mm F (x2)

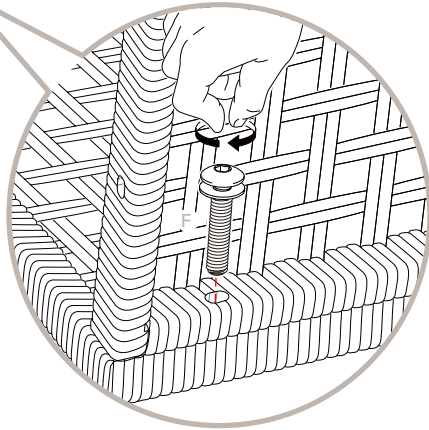
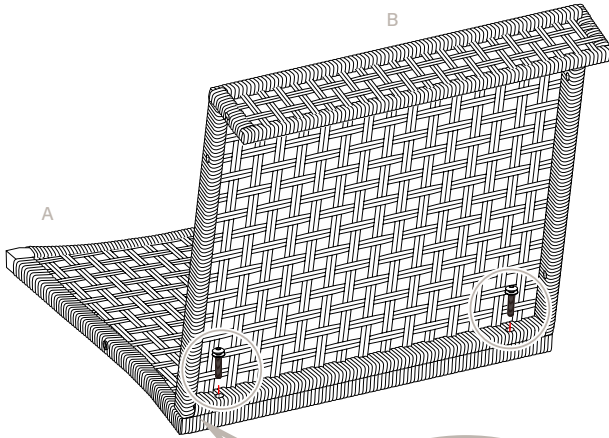

2

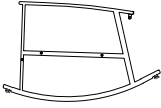

C  M6 X 30mm F (x3)

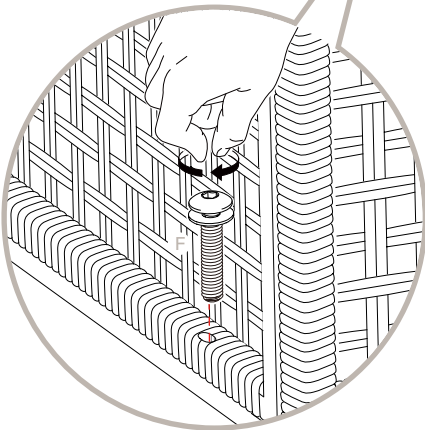
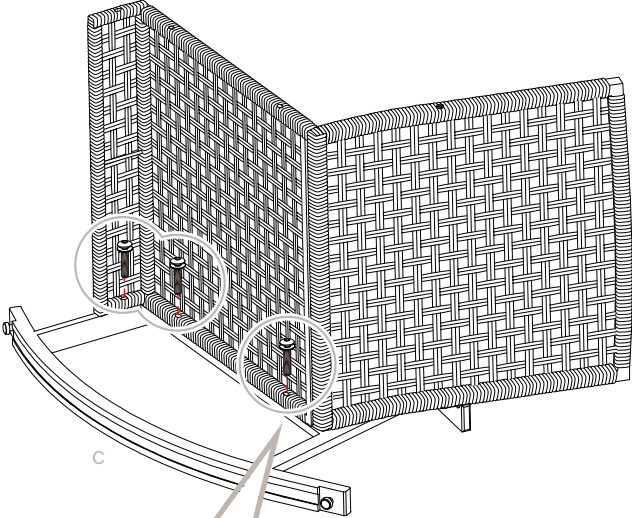

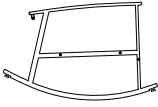

D

 M6 X 30mm F (x3)

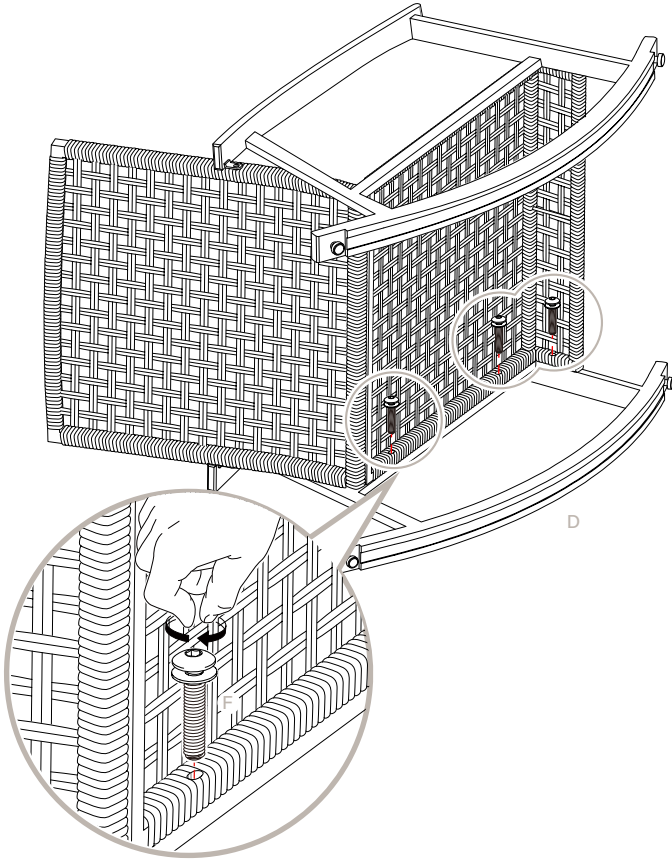

4

M6 X 20mm G (x2)

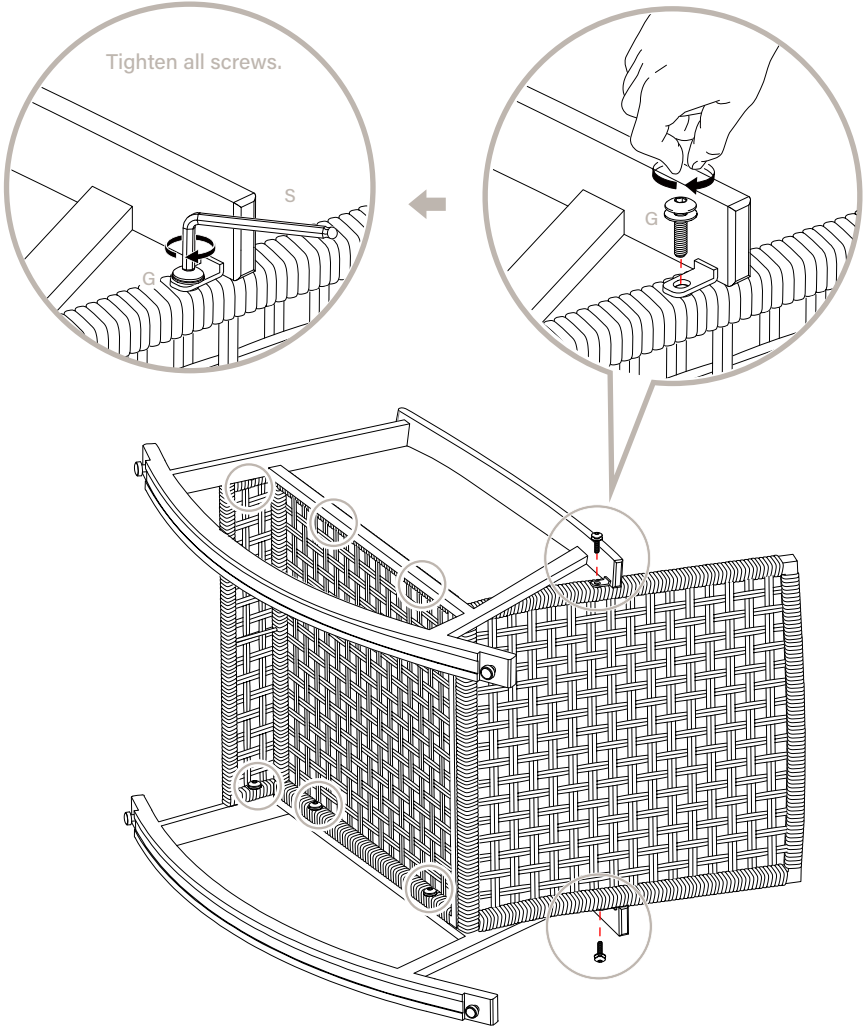

5

