

INSTALLATION GUIDE

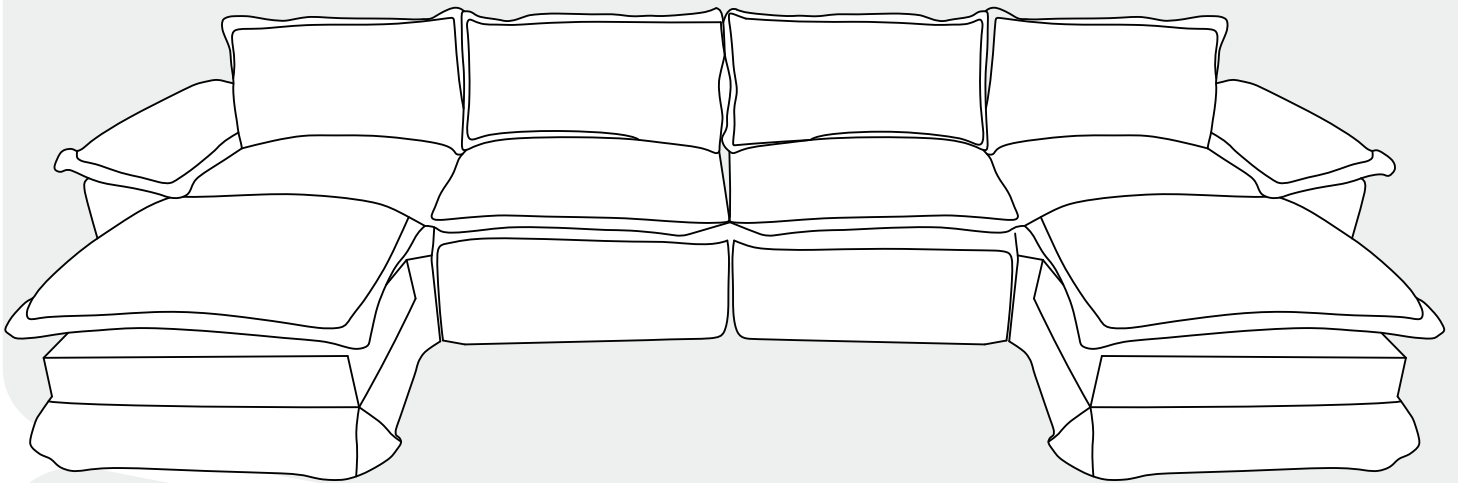

Sectional Cloud Couch

SIZE:

3-Seat & 1 Ottoman
3-Seat & 2 Ottoman
4-Seat & 2 Ottoman



Contact Us: mkxservice@outlook.com

Please be noted

! Note:

This manual applies to all three sofa sets (Set A, Set B, and Set C). The number of boxes you receive depends on the type of sets you bought. Your sofa is shipped in separate packages to ensure safe delivery, so they may not all arrive on the same day.



Set A

3-Seat & 1 Ottoman

Delivered in 2 Separate Packages

Carton 1: 1 single sofa and 1 ottoman

Carton 2: 2 single sofas

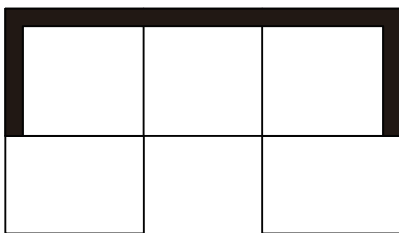

Set B

3-Seat & 2 Ottoman

Delivered in 3 Separate Packages

Carton 1: 1 single sofa and 1 ottoman

Carton 2: 2 single sofas

Carton 4: 1 ottoman

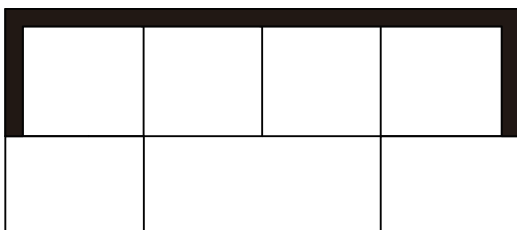

Set C

4-Seat & 2 Ottoman







Delivered in 3 Separate Packages

Carton 1: 1 single sofa and 1 ottoman

Carton 2: 2 single sofas

Carton 3: 1 single sofa and 1 ottoman







Cautions

-  Keep furniture away from heat sources.
-  Avoid cleaning with harsh chemicals. Do not use detergents, solvents, abrasives, spray polishes, or leather cleaners. For spills, use a non-colored, mild soap mixed with warm water (1 part soap to 10 parts water).
-  Protect from direct sunlight. Prolonged exposure can cause material to fade over time.
-  Do not use on-site dry cleaning machines.
-  Prevent climbing or jumping. Children should not climb or jump on the furniture.
-  Use a protective barrier when writing on the furniture surface.
-  For residential use only. Not intended for commercial use.

Warranty Information

We stand behind the quality of our products and aim to ensure every customer is satisfied. We offer a 30-day warranty starting from the date you receive your item. To claim warranty service, you'll need to provide proof of purchase, such as your order number or item receipt. For items outside the warranty period, replacement parts may be available for purchase directly from us. For returns, please refer to the return policy of the retailer or marketplace where you made your purchase. Thank you for choosing our furniture to liven up your home!







Vorsicht

-  Halten Sie Möbel von Wärmequellen fern.
-  Vermeiden Sie die Reinigung mit scharfen Chemikalien. Verwenden Sie keine Reinigungs-, Lösungs- oder Scheuermittel, Sprühpolituren oder Lederreiniger. Bei verschütteten Flüssigkeiten verwenden Sie eine farblose, milde Seife, gemischt mit warmem Wasser (1 Teil Seife auf 10 Teile Wasser).
-  Vor direkter Sonneneinstrahlung schützen. Längere Sonneneinstrahlung kann dazu führen, dass das Material mit der Zeit ausbleicht.
-  Verwenden Sie keine Reinigungsmaschinen vor Ort.
-  Verhindern Sie Klettern oder Springen. Kinder sollten nicht auf die Möbel klettern oder springen.
-  Verwenden Sie eine Schutzunterlage, wenn Sie auf der Möbeloberfläche schreiben.
-  Nur für den privaten Gebrauch bestimmt. Nicht für gewerbliche Nutzung vorgesehen.

Garantieinformationen

Wir stehen hinter der Qualität unserer Produkte und möchten sicherstellen, dass jeder Kunde zufrieden ist. Wir bieten eine 30-tägige Garantie ab dem Datum des Erhalts Ihres Artikels. Um Garantieleistungen in Anspruch zu nehmen, müssen Sie einen Kaufnachweis erbringen, wie z.B. Ihre Bestellnummer oder den Artikelbeleg. Für Artikel außerhalb der Garantiezeit sind Ersatzteile direkt bei uns erhältlich. Für Rücksendungen beachten Sie bitte die Rückgabegerichtlinien des Händlers oder Marktplatzes, bei dem Sie Ihren Kauf getätigt haben. Vielen Dank, dass Sie unsere Möbel gewählt haben, um Ihr Zuhause zu verschönern!







Précautions

-  Tenez les meubles éloignés des sources de chaleur.
-  Évitez de nettoyer avec des produits chimiques agressifs. N'utilisez pas de détergents, solvants, abrasifs, aérosols lustrants ou nettoyants pour cuir. En cas de déversement, utilisez un savon doux et non coloré mélangé à de l'eau tiède (1 part de savon pour 10 parts d'eau).
-  Protégez de la lumière directe du soleil. Une exposition prolongée peut entraîner la décoloration du matériau au fil du temps.
-  N'utilisez pas de machines de nettoyage à sec sur place.
-  Empêchez les enfants de grimper ou de sauter. Les enfants ne doivent pas grimper ou sauter sur le meuble.
-  Utilisez une barrière de protection lorsque vous écrivez sur la surface du meuble.
-  Pour usage résidentiel uniquement. Non destiné à un usage commercial.

Informations sur la Garantie

Nous nous portons garants de la qualité de nos produits et souhaitons assurer la satisfaction de chaque client. Nous offrons une garantie de 30 jours à compter de la date de réception de votre article. Pour bénéficier du service de garantie, vous devrez fournir une preuve d'achat, telle que votre numéro de commande ou votre reçu. Pour les articles hors période de garantie, des pièces de rechange peuvent être achetées directement auprès de nous. Pour les retours, veuillez vous référer à la politique de retour du détaillant ou de la place de marché où vous avez effectué votre achat. Merci d'avoir choisi nos meubles pour égayer votre intérieur !







Precauciones

-  Mantenga los muebles alejados de fuentes de calor.
-  Evite limpiar con productos químicos agresivos. No use detergentes, disolventes, abrasivos, aerosoles pulidores o limpiadores de cuero. Para derrames, use un jabón suave sin color mezclado con agua tibia (1 parte de jabón por 10 partes de agua).
-  Proteja de la luz solar directa. La exposición prolongada puede hacer que el material se desvanezca con el tiempo.
-  No use máquinas de limpieza en seco in situ.
-  Evite que los niños trepen o salten. Los niños no deben trepar ni saltar sobre los muebles.
-  Use una barrera protectora al escribir sobre la superficie del mueble.
-  Solo para uso residencial. No está destinado para uso comercial.

Información de Garantía

Respalamos la calidad de nuestros productos y nuestro objetivo es asegurar la satisfacción de cada cliente. Ofrecemos una garantía de 30 días a partir de la fecha en que reciba su artículo. Para reclamar el servicio de garantía, deberá proporcionar un comprobante de compra, como su número de pedido o el recibo del artículo. Para artículos fuera del período de garantía, las piezas de repuesto pueden estar disponibles para su compra directamente a nosotros. Para devoluciones, consulte la política de devolución del minorista o marketplace donde realizó su compra. ¡Gracias por elegir nuestros muebles para darle vida a su hogar!

Opmerkingen

-  Houd meubels uit de buurt van warmtebronnen.
-  Évitez de nettoyer avec des produits chimiques agressifs. N'utilisez pas de détergents, solvants, abrasifs, aérosols lustrants ou nettoyeurs pour cuir. En cas de déversement, utilisez un savon doux et non coloré mélangé à de l'eau tiède (1 part de savon pour 10 parts d'eau).
-  Protégez de la lumière directe du soleil. Une exposition prolongée peut entraîner la décoloration du matériau au fil du temps.
-  N'utilisez pas de machines de nettoyage à sec sur place.
-  Empêchez les enfants de grimper ou de sauter. Les enfants ne doivent pas grimper ou sauter sur le meuble.
-  Utilisez une barrière de protection lorsque vous écrivez sur la surface du meuble.
-  Pour usage résidentiel uniquement. Non destiné à un usage commercial.

Informatie over de Garantie







Wij staan achter de kwaliteit van onze producten en streven ernaar elke klant tevreden te stellen. Wij bieden een garantie van 30 dagen, ingaand vanaf de datum waarop u uw artikel ontvangt. Om aanspraak te maken op garanteservice, dient u een aankoopbewijs te kunnen overleggen, zoals uw ordernummer of kassabon.

Voor artikelen buiten de garantieperiode kunnen vervangende onderdelen rechtstreeks bij ons worden gekocht.

Voor retourzendingen verwijzen wij u naar het retourbeleid van de retailer of marktplaats waar u uw aankoop heeft gedaan.

Bedankt dat u onze meubels heeft gekozen om uw huis te verfraaien!

Osservazioni

-  Tenere i mobili lontano da fonti di calore.
-  Evitare di pulire con prodotti chimici aggressivi. Non usare detersivi, solventi, abrasivi, lucidanti spray o detersivi per pelle. Per le fuoriuscite, usare un sapone delicato non colorato mescolato con acqua tiepida (1 parte di sapone per 10 parti di acqua).
-  Proteggere dalla luce solare diretta. L'esposizione prolungata può causare lo sbiadimento del materiale nel tempo.
-  Non utilizzare macchine per la pulizia a secco in loco.
-  Evitare di arrampicarsi o saltare. I bambini non devono arrampicarsi o saltare sui mobili.
-  Utilizzare una barriera protettiva quando si scrive sulla superficie del mobile.
-  Solo per uso residenziale. Non destinato all'uso commerciale.

Informazioni sulla Garanzia

Sosteniamo la qualità dei nostri prodotti e miriamo a garantire che ogni cliente sia soddisfatto. Offriamo una garanzia di 30 giorni a partire dalla data di ricezione dell'articolo. Per richiedere il servizio di garanzia, sarà necessario fornire una prova d'acquisto, come il numero d'ordine o la ricevuta dell'articolo.

Per gli articoli al di fuori del periodo di garanzia, le parti di ricambio potrebbero essere disponibili per l'acquisto direttamente da noi.

Per i resi, si prega di fare riferimento alla politica di reso del rivenditore o del marketplace dove è stato effettuato l'acquisto.

Grazie per aver scelto i nostri mobili per ravvivare la vostra casa!

注意事項

- ⚠️ 家具は熱源から離れた場所に設置してください。
- ⚠️ 刺激の強い化学薬品によるお手入れは避けてください。洗剤、溶剤、研磨剤、スプレー式ワックス、レザークリーナーなどは使用しないでください。万が一液体がこぼれた場合は、無色で刺激の少ない石けんを10倍のぬるま湯で薄めたもので拭き取ってください。
- ⚠️ 直射日光を避けてご使用ください。長時間日光にさらされると、素材が色あせる恐れがあります。
- ⚠️ ドライクリーニング機の使用はお控えください。
- ⚠️ お子様が家具の上に登ったり、飛び跳ねたりしないようご注意ください。
- ⚠️ 家具の表面に書き物をする際は、保護バリアを使用してください。

保証について

弊社は製品の品質に自信を持ち、すべてのお客様にご満足いただけるよう努めております。
保証サービスやアフターサービスをご希望の場合は、ご注文番号などの購入証明書のご提示をお願いいたします。
返品に関しましては、ご購入元の販売店またはマーケットプレースの返品ポリシーをご確認ください。
このたびは弊社の家具をお選びいただき、誠にありがとうございます。
弊社の家具をお選びいただき、ご自宅に彩りを添えていただきありがとうございます。

주의사항



- ⚠️ 가구를 열원에서 멀리하십시오.
- ⚠️ 강한 화학 약품으로 청소하지 마십시오. 세제, 용제, 연마제, 스프레이 광택제 또는 가죽 세척제를 사용하지 마십시오. 액체를 엷질렀을 경우, 무색의 순한 비누를 미온수와 섞어 사용하십시오 (비누 1: 물 10 비율).
- ⚠️ 직사광선으로부터 보호하십시오. 장시간 노출 시 재료가 시간이 지남에 따라 변색될 수 있습니다.
- ⚠️ 현장 드라이클리닝 기계를 사용하지 마십시오.
- ⚠️ 오르거나 뛰어내리지 못하게 하십시오. 어린이가 가구에 오르거나 뛰어내리지 않도록 하십시오.
- ⚠️ 가구 표면에 글을 쓸 때는 보호 장벽을 사용하십시오.

보증 정보

우리는 제품의 품질을 보장하고 모든 고객이 만족할 수 있도록 최선을 다합니다. 보증 서비스를 신청하시려면 주문번호나 영수증 등 구매 증빙을 해주셔야 합니다. 반품에 관해서는 쿠팡 플랫폼의 반품 정책을 관심 있게 지켜봐 주시기 바랍니다. 저희 가구를 선택해주셔서 가정에 활력을 더할 수 있습니다!

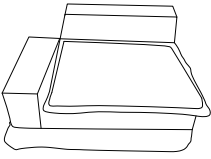
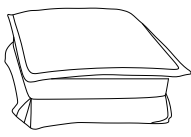

Carton 1

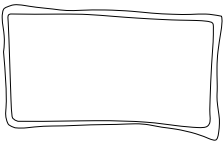
SKU: P1.14.017-2

<p>A</p>  <p>Sofa (x1)</p>	<p>B</p>  <p>Ottoman (x1)</p>	<p>C</p>  <p>Handrail (x1)</p>	<p>D</p>  <p>Back Cushion (x1)</p>
--	---	---	--

Carton 2

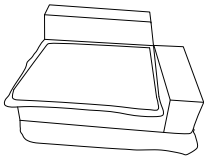
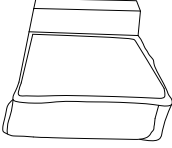
SKU: P1.14.017-1

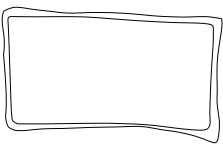
<p>A</p>  <p>Sofa (x1)</p>	<p>B</p>  <p>Sofa (x1)</p>	<p>C</p>  <p>Handrail (x1)</p>	<p>D</p>  <p>Back Cushion (x2)</p>
--	--	---	--

Carton 3

SKU: P1.14.017-4

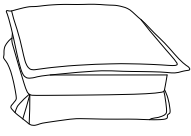
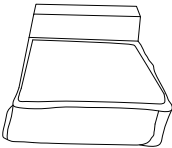
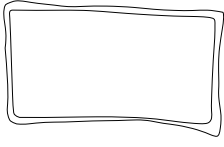
<p>A</p>  <p>Ottoman (x1)</p>	<p>B</p>  <p>Sofa (x1)</p>	<p>C</p>  <p>Back Cushion (x1)</p>	
---	--	---	--

Carton 4

SKU: P1.14.017-3

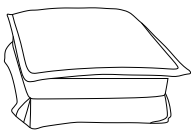
<p>A</p>  <p>Ottoman (x1)</p>			
---	--	--	--

SIZE

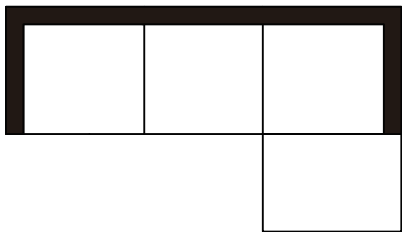
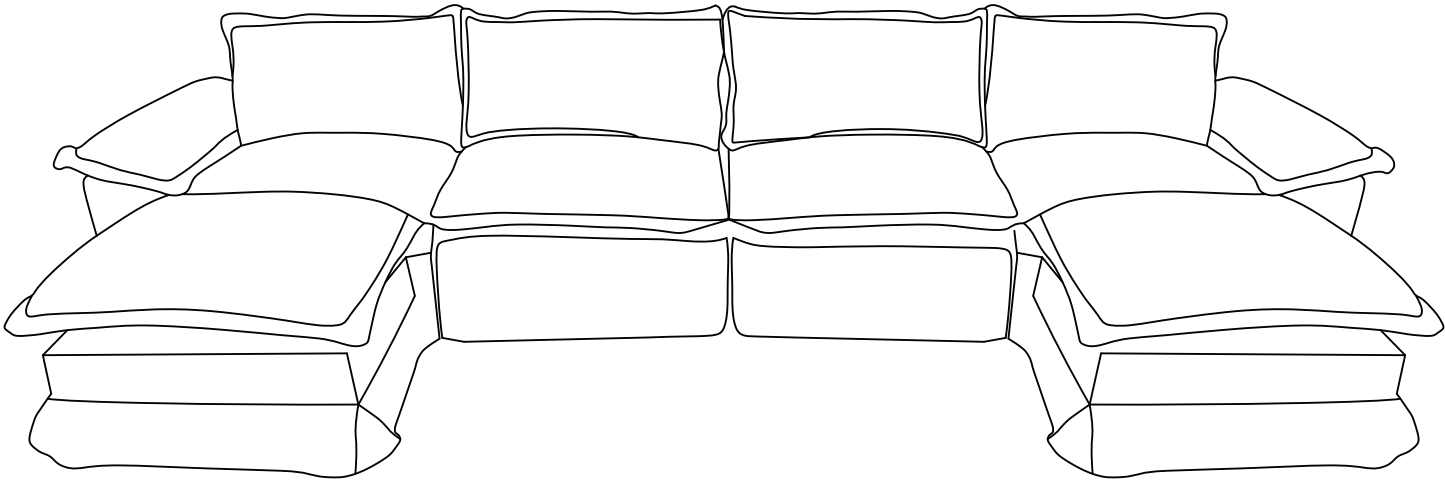

3-Seat & 1 Ottoman

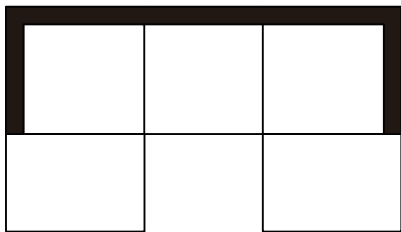

3-Seat & 2 Ottoman

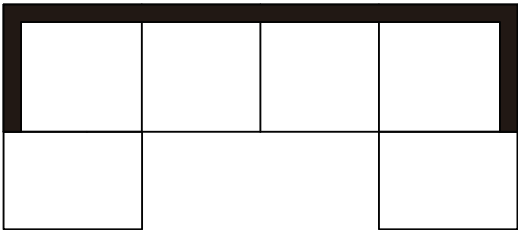

4-Seat & 2 Ottoman

Carton 1

Step 1 Assembly Instruction

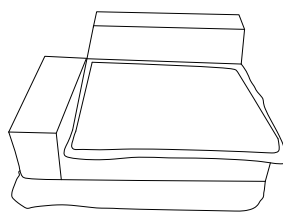
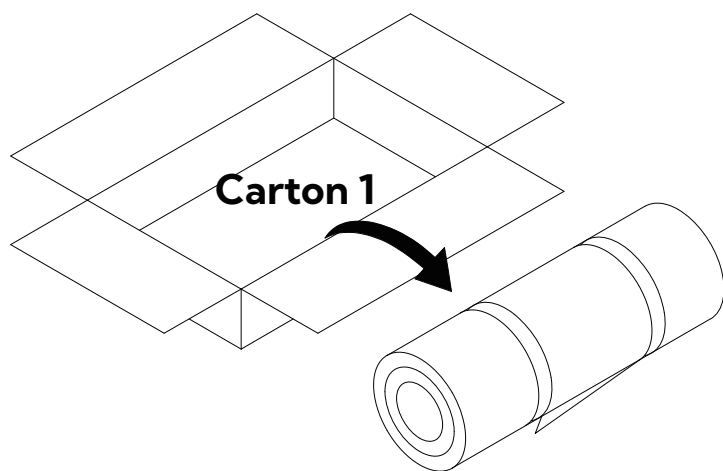

A x1

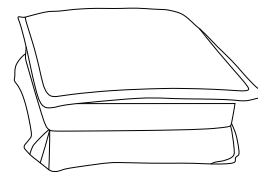

B x1

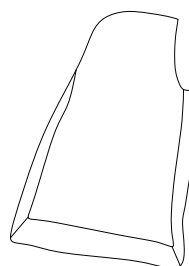

C x1

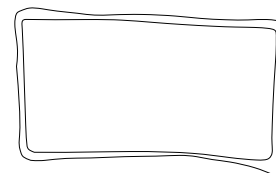

D x1

Step 2

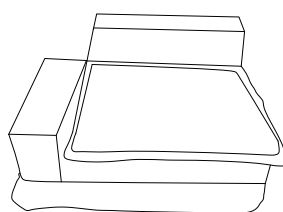
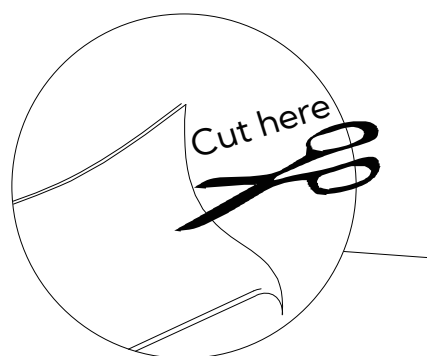

A x1

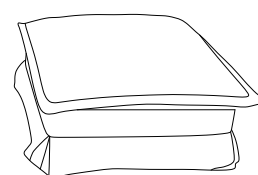

B x1

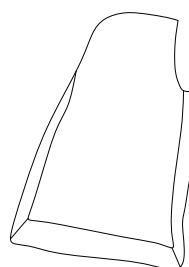

C x1

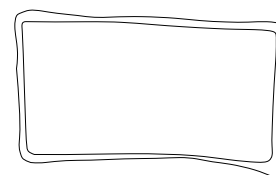

D x1



NOTE: 72 hours to fully expand after being unpackaged!

Carton 2

Step 1 Assembly Instruction

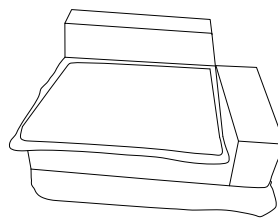
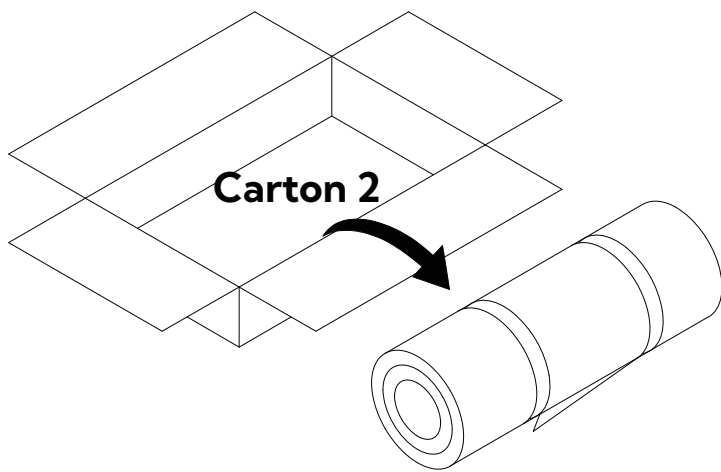

A x1

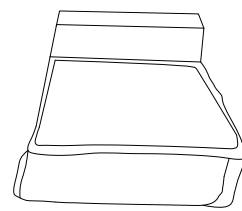

B x1

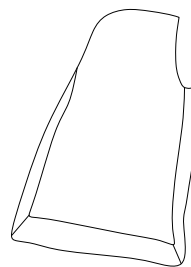

C x1

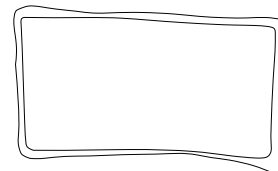

D x2

Step 2

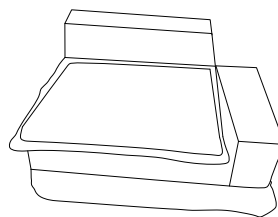
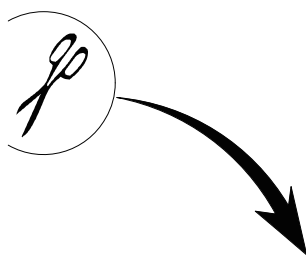
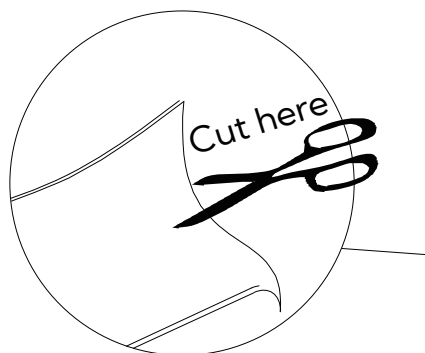

A x1

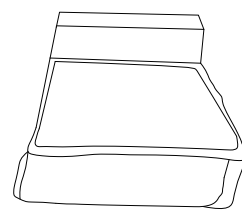

B x1

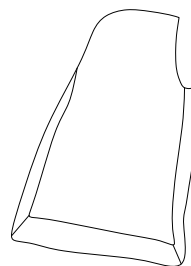

C x1

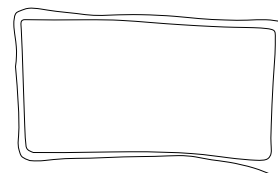

D x2



NOTE: 72 hours to fully expand after being unpackaged!

Carton 3

Step 1 Assembly Instruction

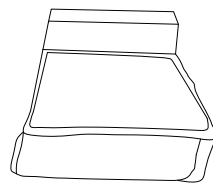
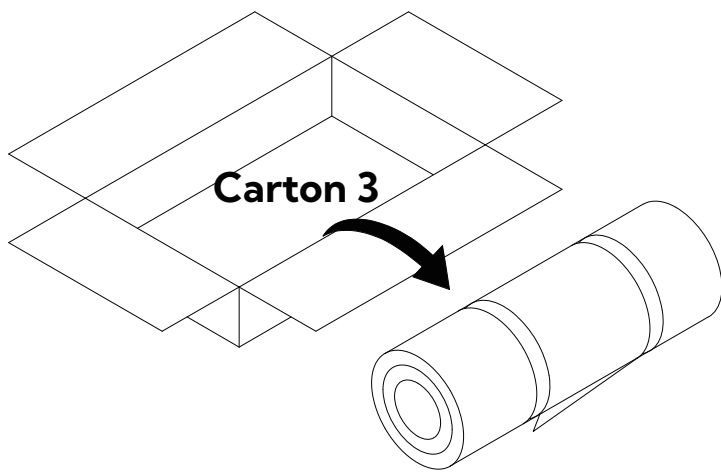

Ax1

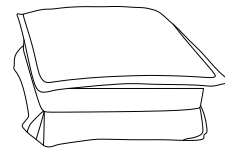

Bx1

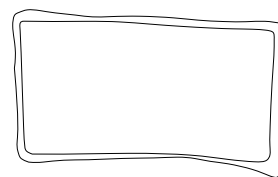

Cx1

Step 2

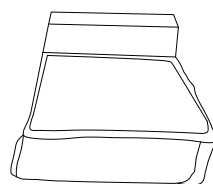
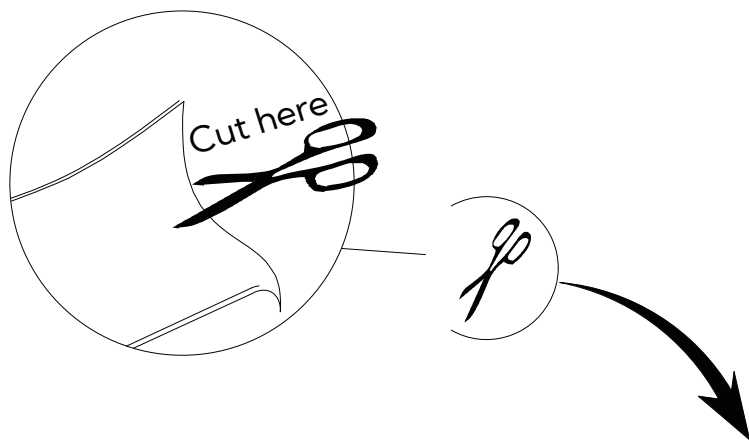

Ax1



Bx1

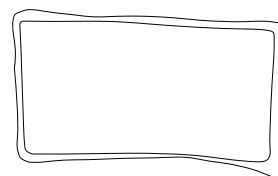

Cx1



NOTE: 72 hours to fully expand after being unpackaged!

Carton 4

Step 1 Assembly Instruction

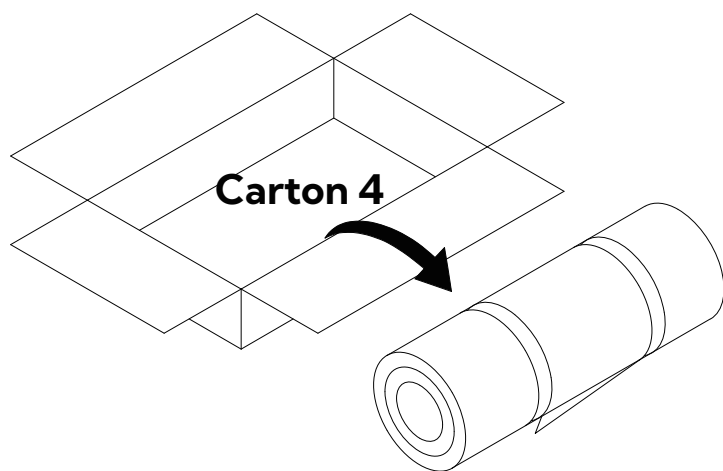

Ax1

Step 2

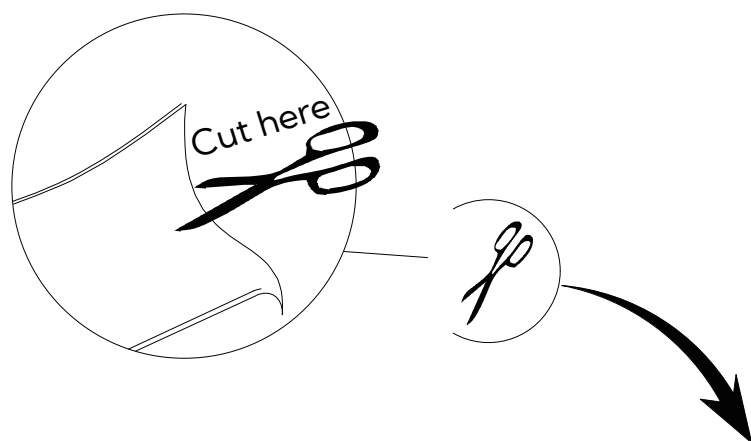

Ax1



NOTE: 72 hours to fully expand after being unpackaged!

Step 1

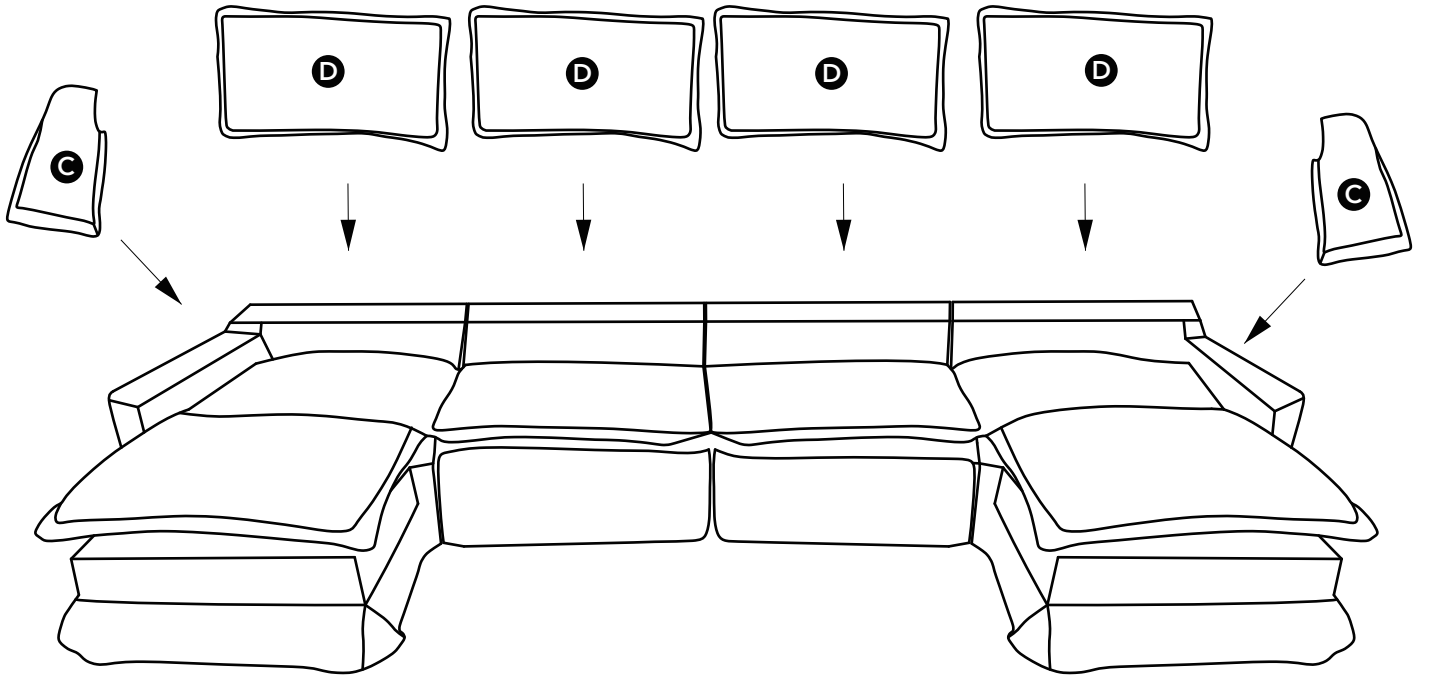

Step 2

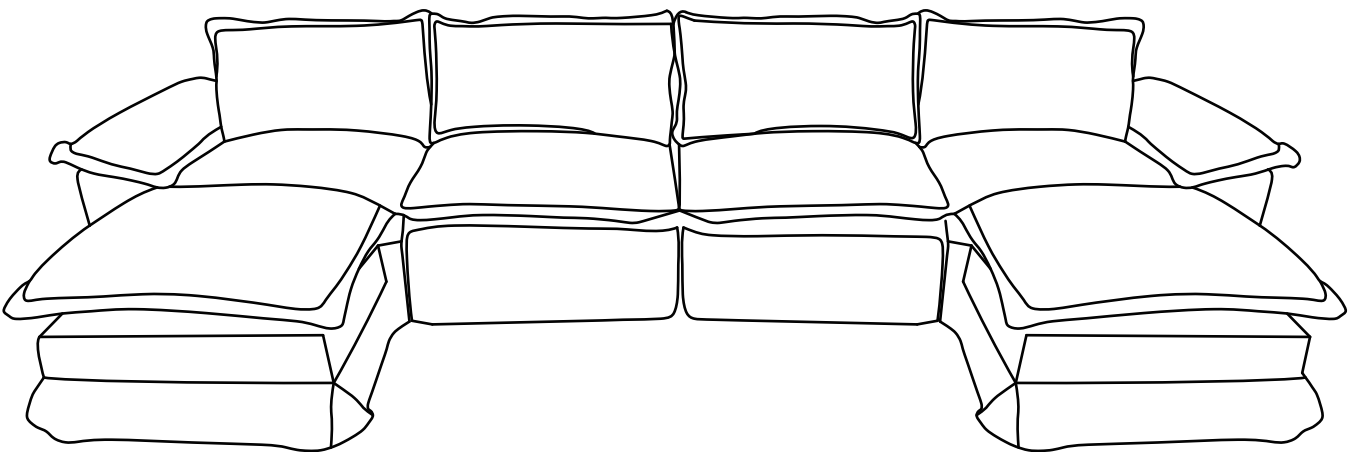

Option 1

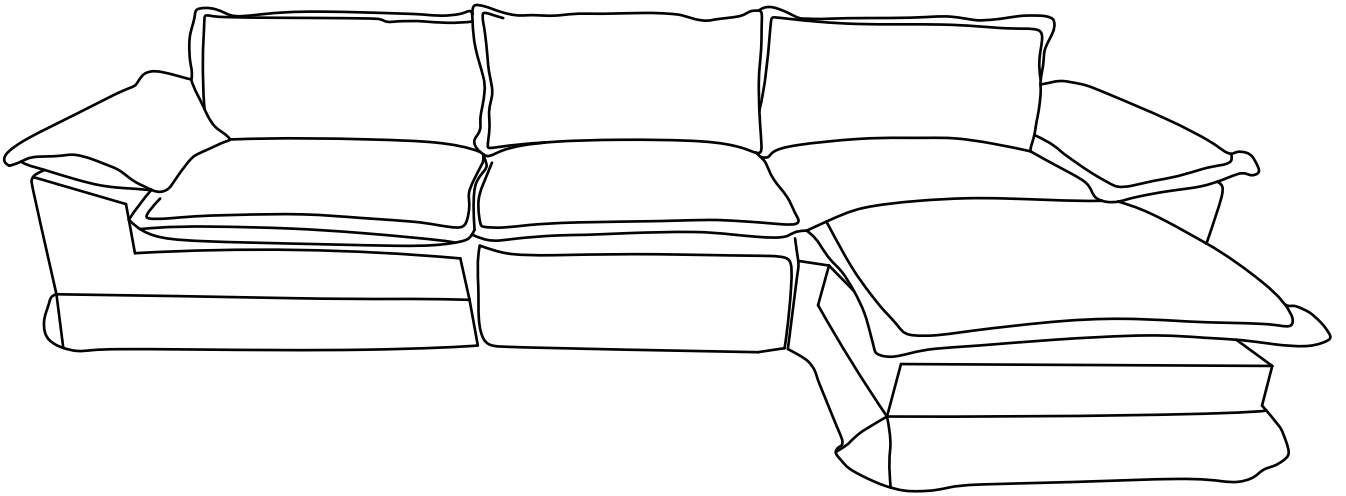

Option 2

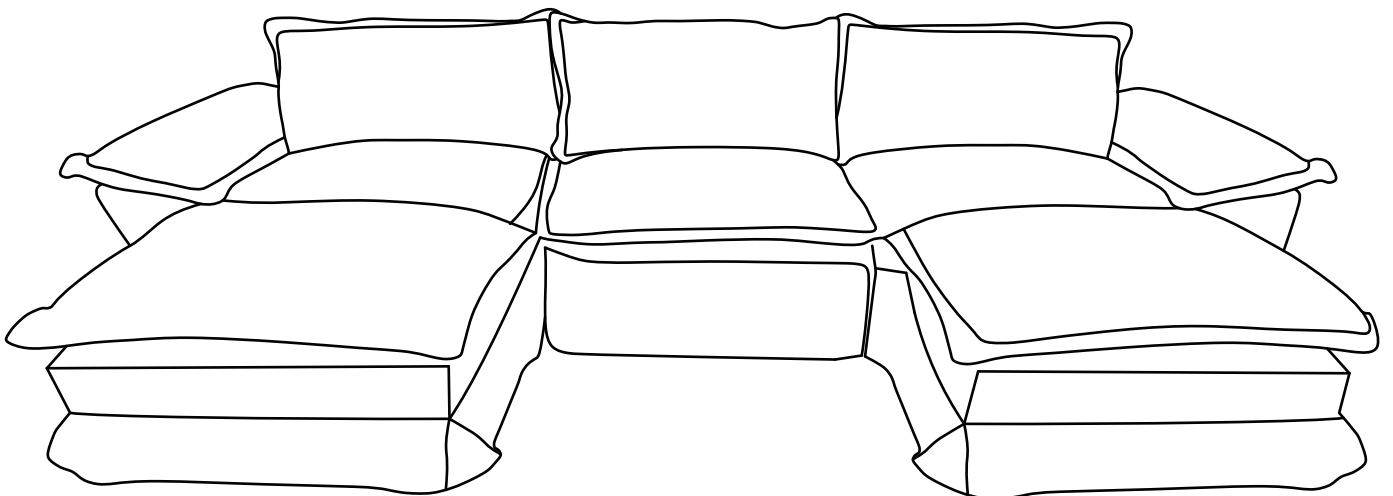



Customer Support:
mkxservice@outlook.com