

# User Manual

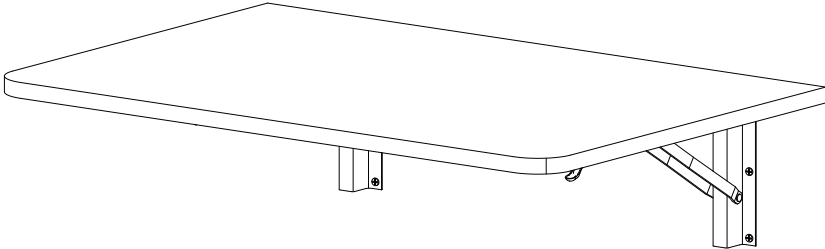

# JAXPETY



Model Number:HG61G1089

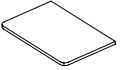
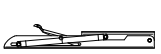
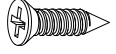

JAXPETY

# Hardware List

			
① 1PC	A 2PCS	M3.5*14mm B 6PCS	M4*35mm C 12PCS
			
D 12PCS			

 Check the package contents before getting started !

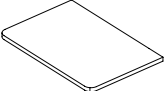
## STEP 1

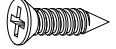
		
① 1PC	A 2PCS	B 6PCS

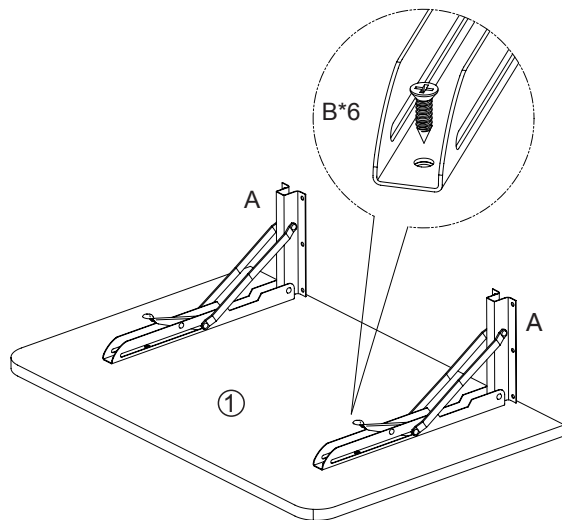

## STEP 2

D 12PCS

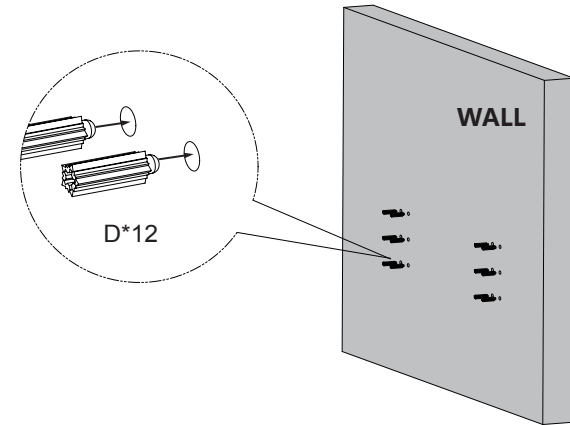

## STEP 3

C 12PCS

