



626-679-3588
service@getprohome.com
www.getprohome.com
162 Atlantic St, Pomona, CA 91768

INSTALLATION MANUAL

SOLID SURFACE BATHTUB

service@getprohome.com
626 679 3588



PRODUCT
INSTRUCTION
VIDEO



THANK YOU!

Dear Valued Customer,

Thanks to your kind support of BESTGO, we hope our product can improve the quality of your life.

As our valued customer, your comments and opinions are very important to us. If you have any concerns, questions, or comments, we hope that you will bring them to our attention.

Please keep the carton and packaging materials until your product is completely installed.

Feel free to contact us if you encounter any problems such as missing parts, or product defects during the installation process. We are happy to provide you with the most sincere service.

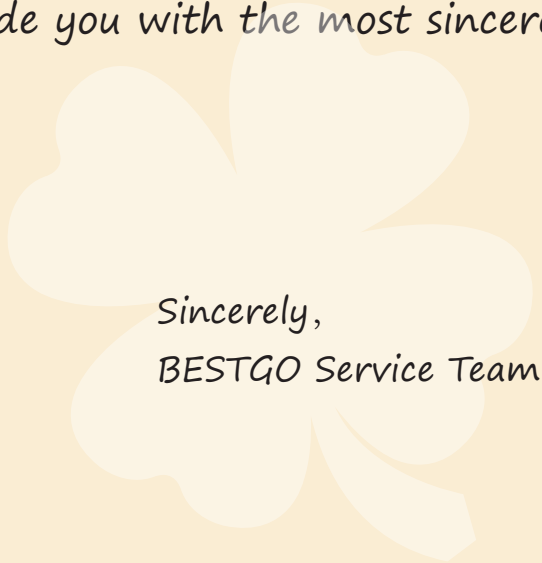

*Sincerely,
BESTGO Service Team*



Please read all instructions carefully before proceeding with installation.



Due to the complexity of the installation procedure, a professional plumber is required.

TABLE OF CONTENTS

1. Pre-installation Checklist	P3
2. Tools Required	P6
3. Installation Instructions	P7
4. Care & Maintace	P13
5. Warranty	P15

PRE-INSTALLATION CHECKLIST

Before installing BESTGO freestanding bathtub, it's important to perform a pre-check to ensure a smooth and successful installation. Here are some key factors to consider during the pre-installation check:

1. Inspect the bathtub

- Careful remove the tub from it's box/crate. It's required the lift to lift up the box. Do not carry the bathtub by its panel.
- To avoid scratches or damages, be sure to set it on the soft blanket on the top of the cardboard.
- Inspect the bathtub for any damages, if any damages are found please get in touch with us, the contact information is listed on the bottom of each page.

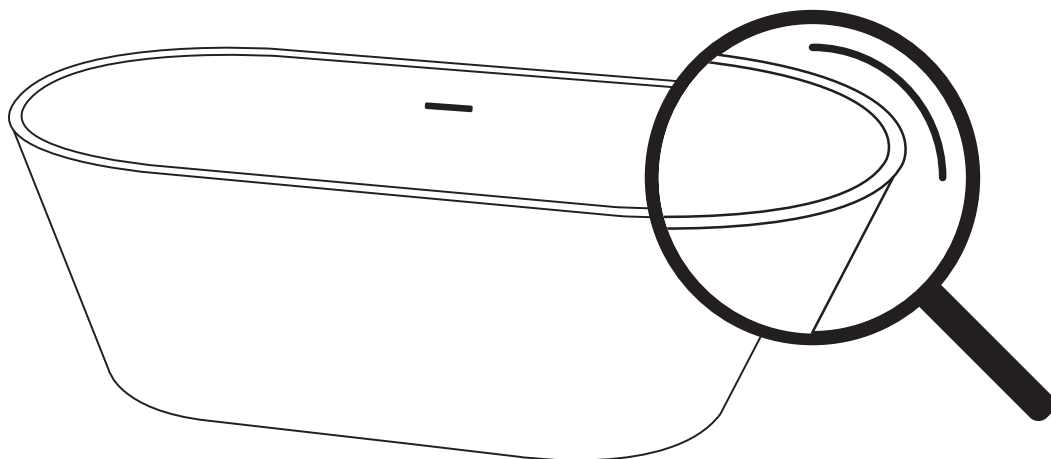
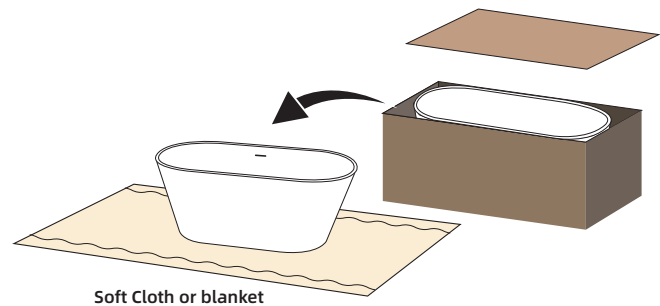
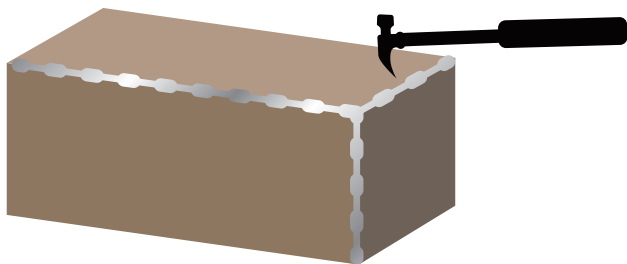

2. Leak test of the bathtub

- Set the bathtub on two 4"X4" lumber pieces, in order to have access from the bottom of the bathtub.
- Put a tray beneath the bathtub. Check for any leaks around the drain and pipe. If a leakage occurs please disassemble the drain line, you can apply a plumbing silicone caulk to fix the leakage.

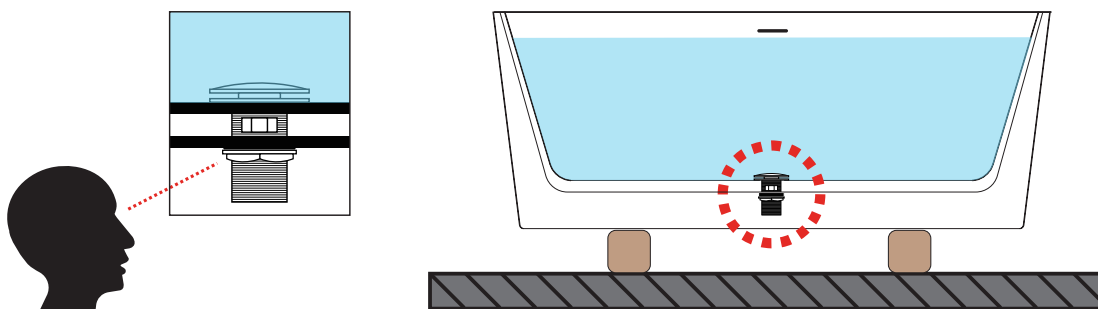
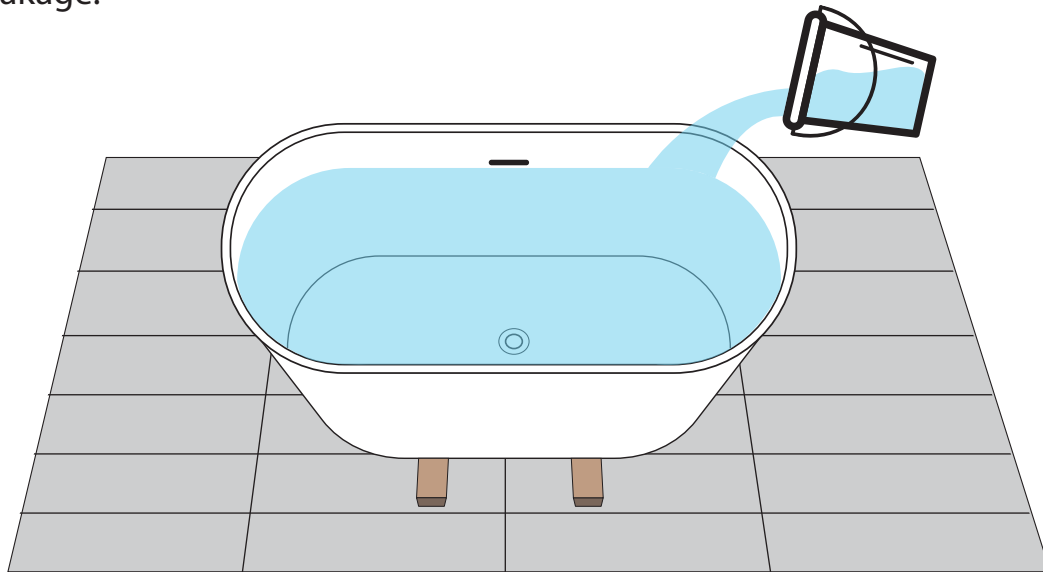

3. Measurement and Fit

- Measure the space where the freestanding bathtub will be installed to ensure it fits properly.
- Check the dimensions of the bathtub and compare them with the available space, including doorways and hallways for delivery and installation.

4. Floor Strength

- Ensure that the floor can support the weight of the bathtub when filled with water and occupants. Consider reinforcing the floor if necessary.

5. Plumbing Connections

- Check the existing plumbing connections to ensure they are compatible with the bathtub's drain and overflow assembly.
- Confirm the location of the drain and overflow openings on the bathtub align with the existing plumbing.

6. Accessibility

- Ensure there is enough space around the bathtub for installation and maintenance access.
- Check if there are any obstacles or obstructions that may hinder the installation process.

7. Drainage

- Check the drainage system to ensure it is clear and functioning properly. Clear any clogs or debris that may affect drainage before installing the bathtub.

8. Utilities

- Ensure that water supply lines and drainage pipes are accessible and properly connected for the bathtub installation.
- Consider the location of electrical outlets if the bathtub has built-in features that require power.

9. Installation Requirements

- Gather all necessary tools and materials needed for the installation process.

By conducting a thorough pre-installation check and addressing any potential issues or concerns, you can ensure a successful and trouble-free installation of your freestanding bathtub. If you encounter any challenges or uncertainties during the pre-check, consider consulting a professional plumber or contact our customer service team for assistance. Our contact information is listed at the bottom of each page.

INSTALLATION INSTRUCTIONS

Installing a freestanding bathtub is a rewarding project that can enhance the aesthetic and functionality of your bathroom. Here is a general guide on how to install a freestanding bathtub:

TOOLS REQUIRED



Level

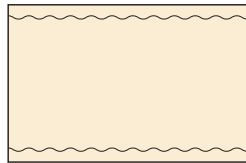

Soft Cloth or blanket



Tape Measure

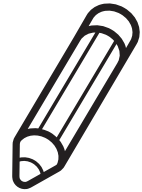

Pencil



Construction Adhesive



Hammer

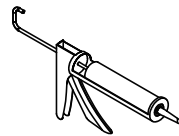

Silicone caulk

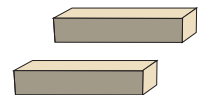

Shims / Lumber

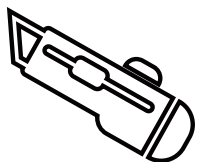

Knife

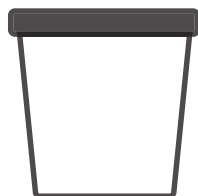

Plumbers putty

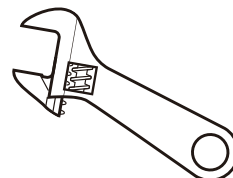

Adjustable wrench

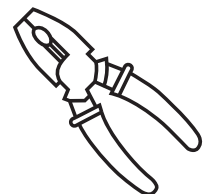

Furring strips

INSTALLATION STEPS

STEP 1

Prepare the Installation Area

Ensure the floor is level and can support the weight of the bathtub and water. Measure the space to ensure the bathtub fits properly.

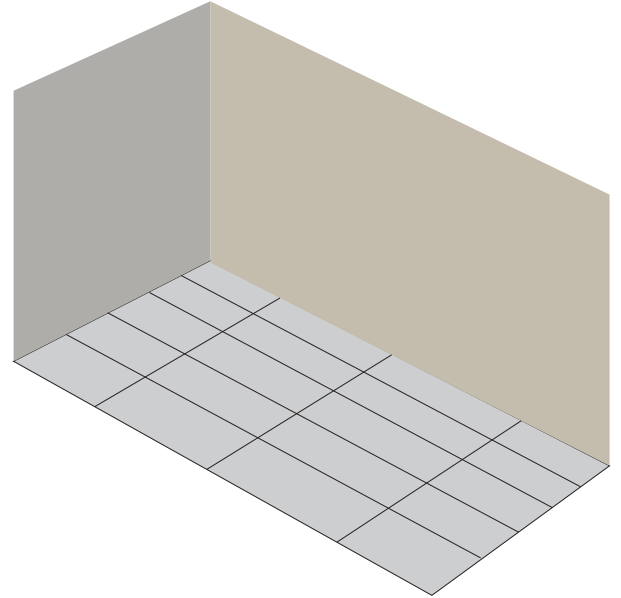

STEP 2

Position the Bathtub

Carefully position the freestanding bathtub in the desired location, ensuring it is level. Use shims if needed to stabilize the bathtub and ensure it is even.

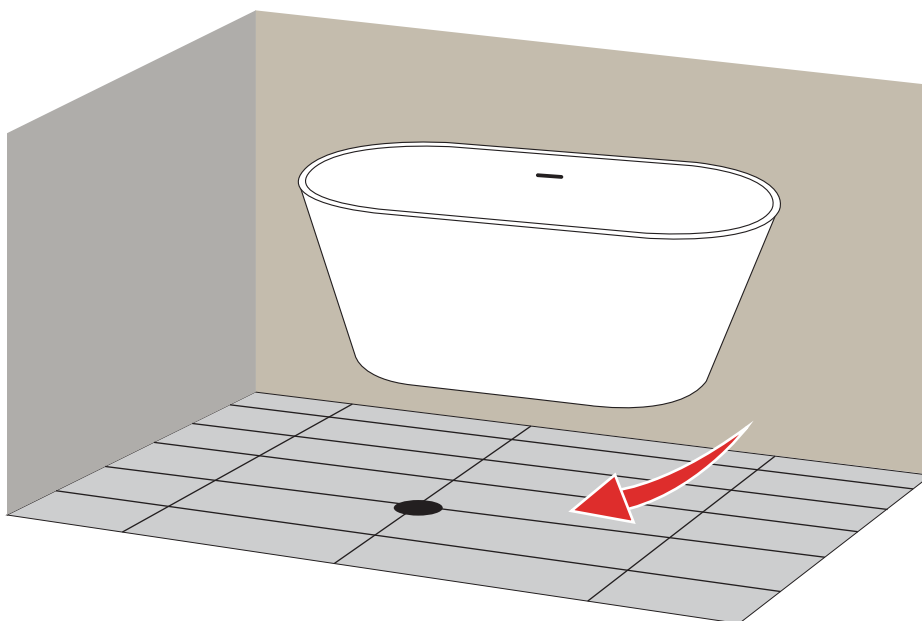

STEP 3

Mark locations

- Use a pencil to mark the outline of the bathtub's exact installed location and the drain hole on the floor.
- Move the bathtub away so that the plumbing can be installed.

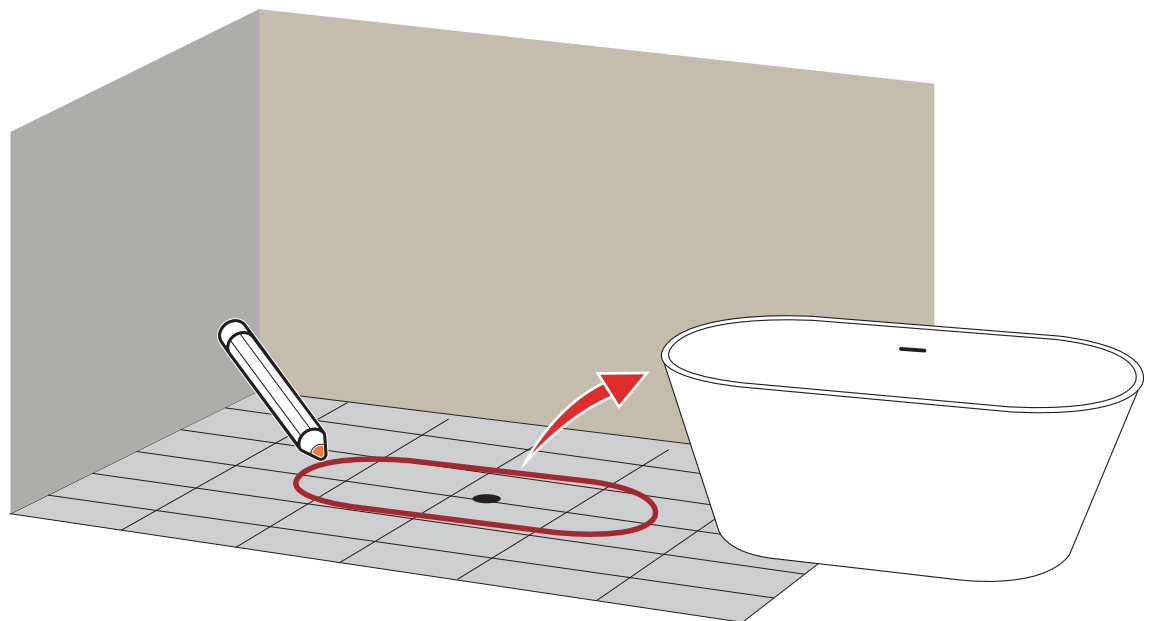
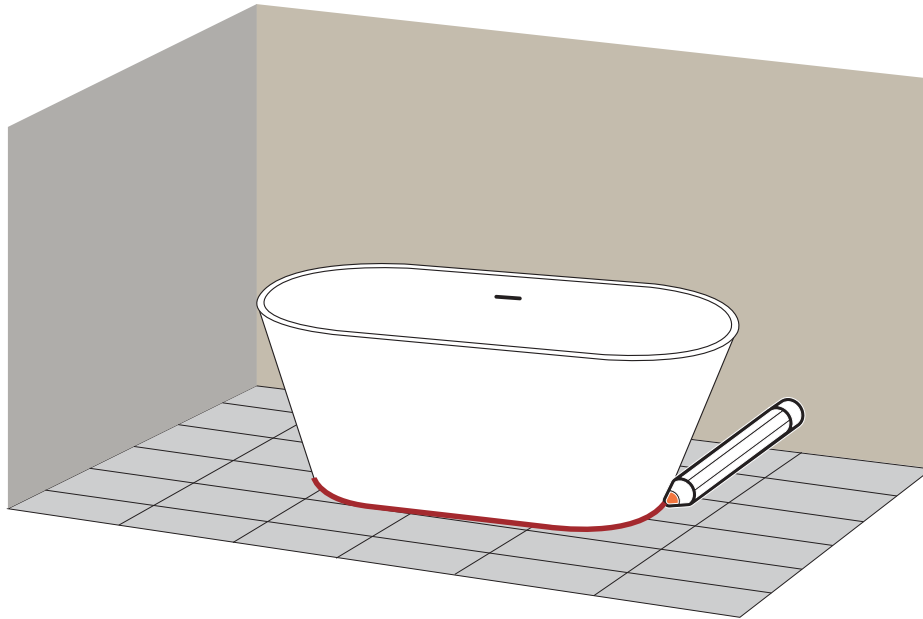

STEP 4

Measure & cut

Measure and cut the tail piece to the appropriate length to reach the trap adapter. When setting the tub drain, insert tail piece with 1-1/2" slip joint and rubber washer into the trap adapter and tighten properly.

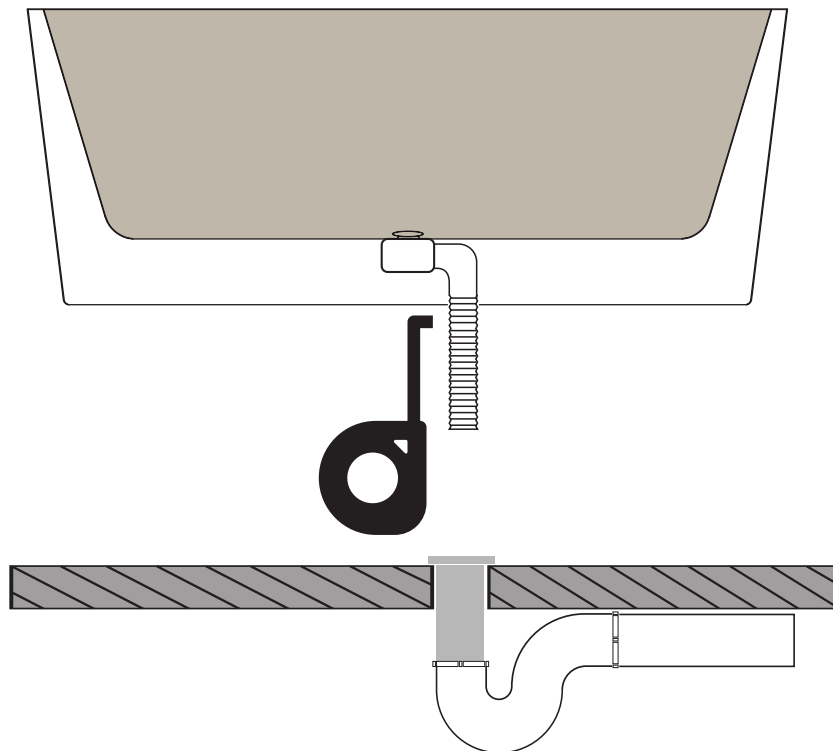
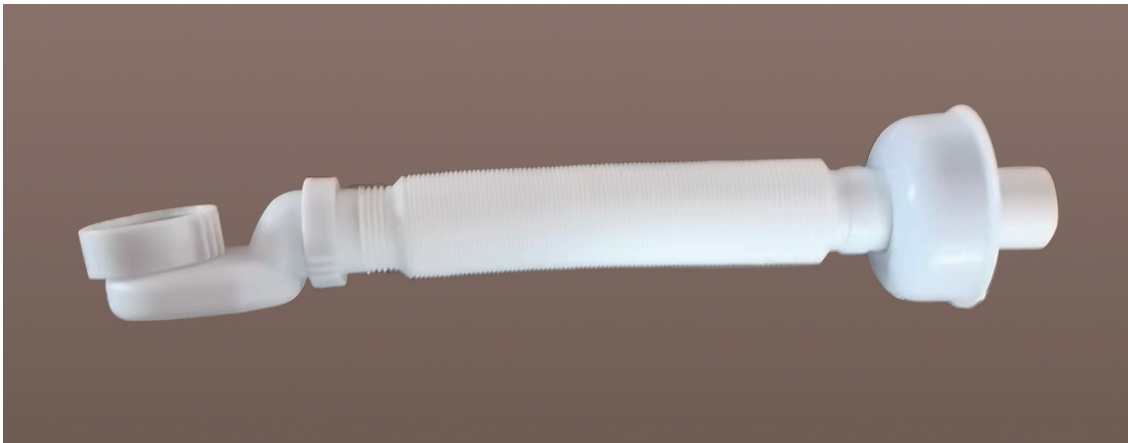

STEP 5

Connect the Drain

- Flip the tub over and carefully set the tub into position with the tailpiece assembly to the waste vent and connect to the drain.

-Connect the drain pipe to the bathtub drain using the provided parts. Ensure the connections are tight and secure. Use a P-trap and tubing cutter to connect the drain to the existing plumbing.

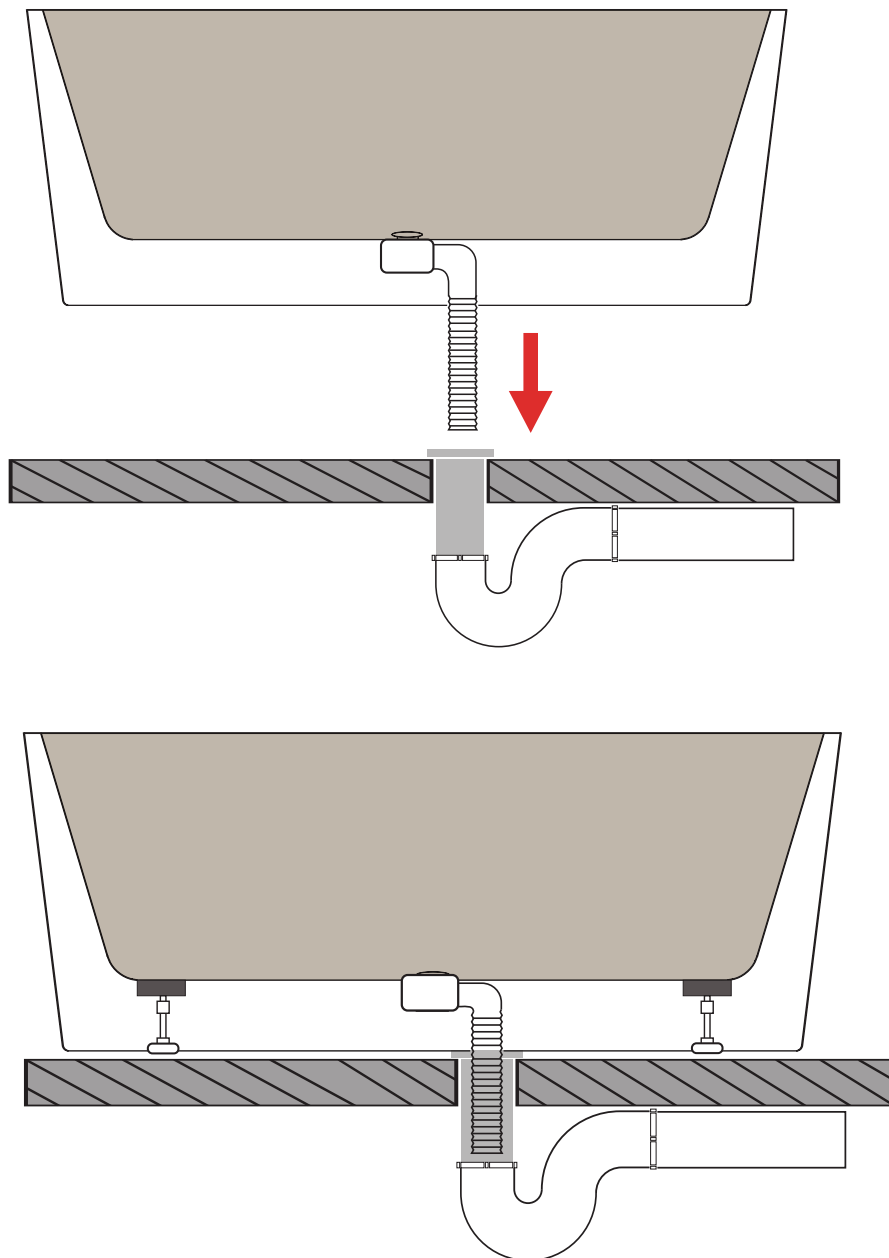

STEP 6

Secure the Bathtub

Secure the bathtub to the floor if necessary. Some freestanding bathtubs have leveling feet or brackets that need to be anchored to the floor for stability.

STEP 7

Caulk the Seams

Apply silicone caulk along the edges of the bathtub where it meets the floor and walls to create a watertight seal. This will prevent water from seeping underneath the bathtub.



 24 hours

STEP 8

Test the Tub

Fill the bathtub with water to check for any leaks or issues. Ensure the drain is working properly and that the bathtub is securely installed.

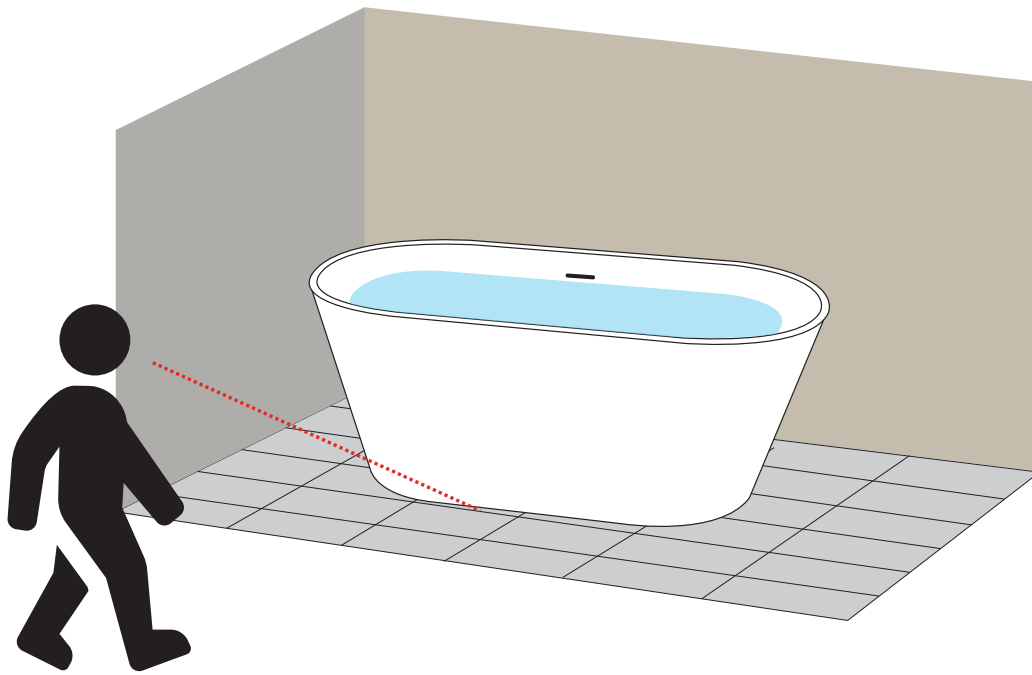

STEP 9

Finish and Clean Up

Trim any excess caulk and clean up any debris from the installation process. Wipe down the bathtub to remove any dirt or marks.

By following these steps and the manufacturer's specific instructions, you can successfully install a freestanding bathtub in your bathroom. If you are unsure about any part of the installation process, consider consulting a professional plumber for assistance.

CARE & MAINTACE

Solid surface bathtubs are made from a mixture of acrylic, polyester resins, and natural minerals, making them highly durable and resistant to scratches, stains, and impact damage. The big difference between acrylic and surface surface bathtub is that the solid surface bathtub can be Repairable, such as minor scratches, stains, or damages on solid surface bathtubs can often be repaired and refinished, extending the lifespan of the fixture and maintaining its appearance.

1.Regular Cleaning:

Clean the bathtub regularly with a mild, non-abrasive cleaner and a soft cloth or sponge. Avoid harsh chemicals or abrasive cleaners that can damage the matte surface.

2.Avoid Scratches:

Use gentle cleaning tools and avoid abrasive scrubbers to prevent scratches on the matte surface. Be cautious when placing objects on the bathtub surface to avoid damage.

3.Stain Removal:

For stubborn stains, use a mixture of baking soda and water or a mild abrasive cleaner specifically designed for solid surface materials. Gently scrub the stained area and rinse thoroughly.

4.Prevent Build-Up:

Rinse the bathtub after each use and wipe it dry with a soft cloth to prevent soap scum and mineral build-up. This helps to maintain the matte finish.

5.Avoid Harsh Chemicals:

Avoid using harsh chemicals, bleach, or abrasive cleaners on the bathtub surface, as they can damage the matte finish.

6.Sealant Maintenance:

Some solid surface bathtubs may require periodic resealing to maintain their appearance and protect the matte surface. Follow the manufacturer's recommendations for sealing and maintenance.

7.Avoid Extreme Temperatures:

Avoid exposing the bathtub to extreme temperatures, as sudden changes in temperature can damage the solid surface material. Use warm water for cleaning and avoid placing hot objects directly on the surface.

8.Regular Inspection:

Periodically inspect the bathtub for any signs of damage, scratches, or wear. Address any issues promptly to prevent further damage.

HOW TO REMOVE MINOR CUTS OR SCRATCHES?

Minor cuts or scratches on a matte finish solid surface bathtub can often be repaired with the right techniques and products. Here is a general guide on how to repair scratches on a matte finish solid surface bathtub:

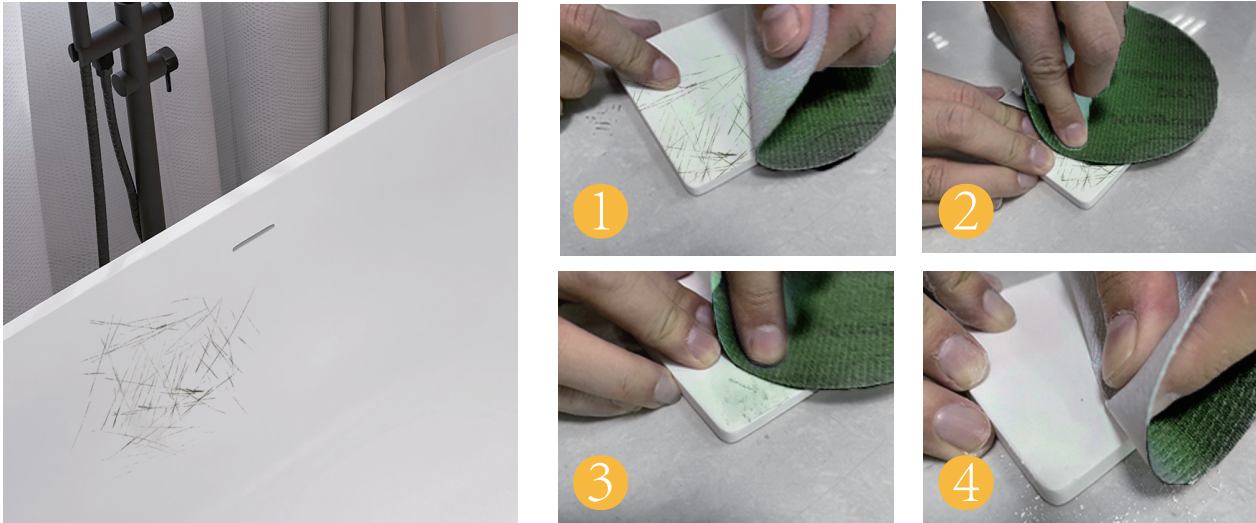

1. Remove the scratch with fine grit sanding pad (approximately 1000 qrmt). Rub over scratch in a straight line, not circular motion to remove it.

★ Periodically switch rubbing direction 90°. Be sure the entire scratch is removed and shape appropriately to match the surrounding area.

2. If the 1000 qrmt sandpaper cannot remove it, try the next heaviest grit sanding pad. To minimize dust during sanding, wet the surface. Rinse pad periodically to clean residue.

★ Clean surface with water. Select the next heaviest grit until desired level is achieved. For matte, you should be ending at about 600 grit.

HOW TO REMOVE WATER STAINS OR STUBBORN STAINS?

1. Water stain, blot

- ★ Clean with damp cloth and wipe dry.
- ★ Most dirt and residue can be rinsed with soapy water or mild ammonia cleaner and wiped dry.
- ★ If the residue still on it, pls repeat the second step again.
If the residue cannot be removed by soapy water or cleaner, please try to remove it by sandpaper.
- ★ Occasionally wipe surface with a household bleach dilution(50 parts water/1 part bleach). Rinse basin or bathtub thoroughly with water and wipe dry.
- ★ Do not use abrasive cleaners or cleaners containing strong acids, alkalis or strong ammonia to remove stains.

LIMITED WARRANTY COVERAGE

1 YEARS LIMITED WARRANTY

BESTGO products are made with quality materials and excellent craftsmanship to provide the customers a long-lasting product. In the case of any defects in materials or craftsmanship under regular use were inspected in the first one year of delivery, BESTGO will provide replacement parts at no charge, or at its option, replace any product or part of the product that is deemed defective, under normal installation, use, service and maintenance. This warranty applies only to the original purchaser. Proof of purchase will be required in the case of a claim.

BESTGO will, as its option

- (1) Repair or replace the defective part(s) or product(s) at no charge;
- (2) Issue a refund of the original purchase price of the product(s) (Valid within 30 days from the date of delivery);
- (3) Issue a credit to be applied toward the purchase of a new BESTGO product shipping/delivery charges may apply and are in BESTGO's sole discretion.

BESTGO recommends the installations to be made by a licensed, professional plumber. BESTGO will not be held responsible for any damage or product failure due to improper installation, misuse, or failure to use a licensed professional. BESTGO is not responsible for any removal or installation cost.

This limited warranty shall not apply to goods that have been subject to accident, negligence, improper installation, product abuse, product misuse, or use of cleaners containing abrasives, alcohol or other organic solvents, whether performed by a contractor, service company, or yourself, are excluded from this warranty.

BESTGO responsibility under this limited warranty is limited to only to replacement parts and no other costs.

BESTGO will not be responsible for labor charges and/or damage incurred by installation, repair, or replacement, nor for any indirect incidental or consequential damages, losses, injury, or costs of any nature relating to this product.

Except as provided by law, this limited warranty is instead of and excludes all other warranties, conditions, and guarantees, whether expressed or implied, statutory or otherwise, including without restriction those merchant ability of fitness for use.

RESPONSIBILITIES OF OTHERS

Inspecting the unit before installation is the responsibility of the installer or building contractor who acts on behalf of the user. They are responsible for ensuring the unit is free of defects or damage. Notices are placed on and in the unit and on the shipping carton advising the installer of this responsibility. In the event of a problem, the unit must not be installed.

BESTGO is not responsible for failures or damage that could have been discovered, repaired, or avoided by proper inspection and testing before installation.

Damage occurring in transit is the responsibility of the carrier. The user or installer MUST open the crate and inspect the unit for damage when it's delivered. If damage is discovered, it must be reported immediately to the seller and the carrier in writing, and an inspection requested. Failure of the carrier to respond should be reported to the seller and the carrier. Your freight claims should be filed promptly thereafter.

LIMITATIONS AND EXCLUSIONS

This warranty does not cover instances of negligence, misuse, abuse, improper installation, carelessness, accident, hard water or mineral deposits, exposure to corrosive materials, misapplication, damages caused by improper maintenance, alteration of the product, or failure to follow care or installation instructions enclosed with your product.

This warranty is void if the BESTGO is subject to alteration, or if repairs are attempted by anyone other than an authorized agent of BESTGO. This warranty does not extend to plumbing or components installed by dealers, installers or by any party other BESTGO.

BESTGO will not be liable for loss of use of the BESTGO inconvenience, or any other incidental or consequential costs, expenses, or damages. Please note that some states do not allow the exclusion or limitation of incidental damages.



DISCLAIMER

Except as expressly provided, there shall be no warranty or obligation, express or implied, oral or statutory. No dealer or other person has the authority to make any warranties or representations concerning BESTGO or its products. In no event shall BESTGO be held responsible for any such warranties or representations.

WARRANTY SERVICE

NOTE: When requesting a warranty, be sure to have the following:

- Copy of original invoice
- Date of installation
- Description and pictures of the defect
- Model number or description of the model

To obtain warranty service and replacement parts, please contact BESTGO Customer Service. BESTGO will determine whether to repair or replace your product, issue a refund, or issue a credit.

WARNING: Content may contain sharp and other possibly harmful pieces and may cause hazard to children and adults, BESTGO is not responsible in any way for personal damage.

HOME SERVICES



INSTALLATION VIDEO

Missing Part or Defective?
DO NOT RETURN

Please Contact the Customer Service Team

✉ service@bestgosupplychaininc.com

☎ 626 679 3588 / 626 682 1512

If you really want to return the goods, please fill in the following form
Your real feedback is our biggest support



RETURN FORM

Customer Name	Purchase Order ID	Qty	Return Reason	Return Address
			Please tick the reasons for return according to the actual situation	
			<input type="checkbox"/> A= No longer Needed	ATTN: BESTGO
			<input type="checkbox"/> B= Choose Wrong Product	ADD: 162 Atlantic St, Pomona, CA, 91768
			<input type="checkbox"/> C= Product Defective	CELL : 626 679 3588
			<input type="checkbox"/> D= Damaged Merchandise	Please contact us for return label if needed.
			<input type="checkbox"/> E= Missing Parts	
			<input type="checkbox"/> F= Others	

KINDLY REMINDER

*If the goods have quality problems, please take a photo and send it to customer service within 48 hours. service@bestgosupplychaininc.com

*If returning goods due to non-quality issues, please ensure that the goods and their packaging/gifts are intact so as not to affect secondary sales.

*Please fill out the return application form and send it back with the product (packaging,item description , gifts, etc.)