

ASSEMBLY INSTRUCTIONS

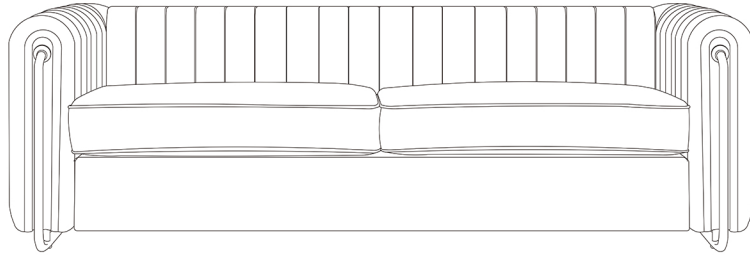

A: Left Arm x 1pc

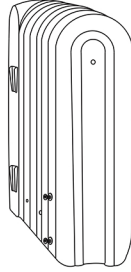

B: Right Arm x 1pc

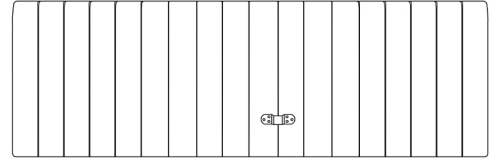

C: Sofa Back x 1pc

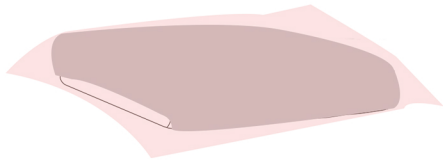

D: seat cushion x 2pcs



E: Seat Board x 1pc



F: Front Board x 1pc

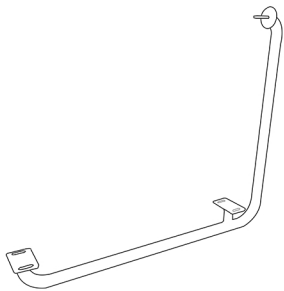

G: Legs x 2pcs

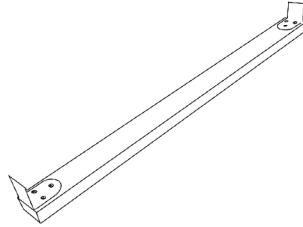

H: Mid Bar x 1pc

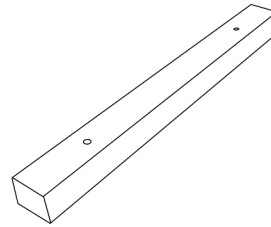

I: Side Bar x 2pcs

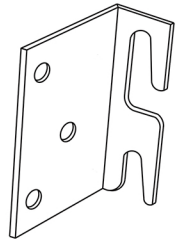

J: Bracket x 1pc

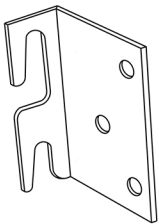

K: Bracket x 1pc

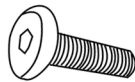

**L: M6*20MM
x 16pcs**

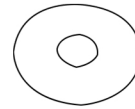

M: Washer x 14pcs

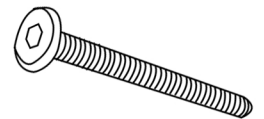

N: M6*70MM x 4pcs



O: Hex Keys x 1pc

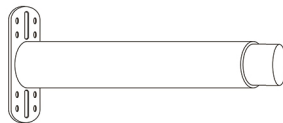

P: Mid Leg x 1pc

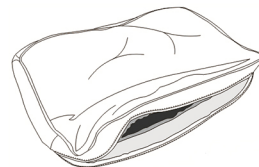

Q: seat cushion cover x 2pcs

Step 1. Insert the sofa back(C) into the left armrest(A), then insert the sofa back into right armrest(B) step by step as following.

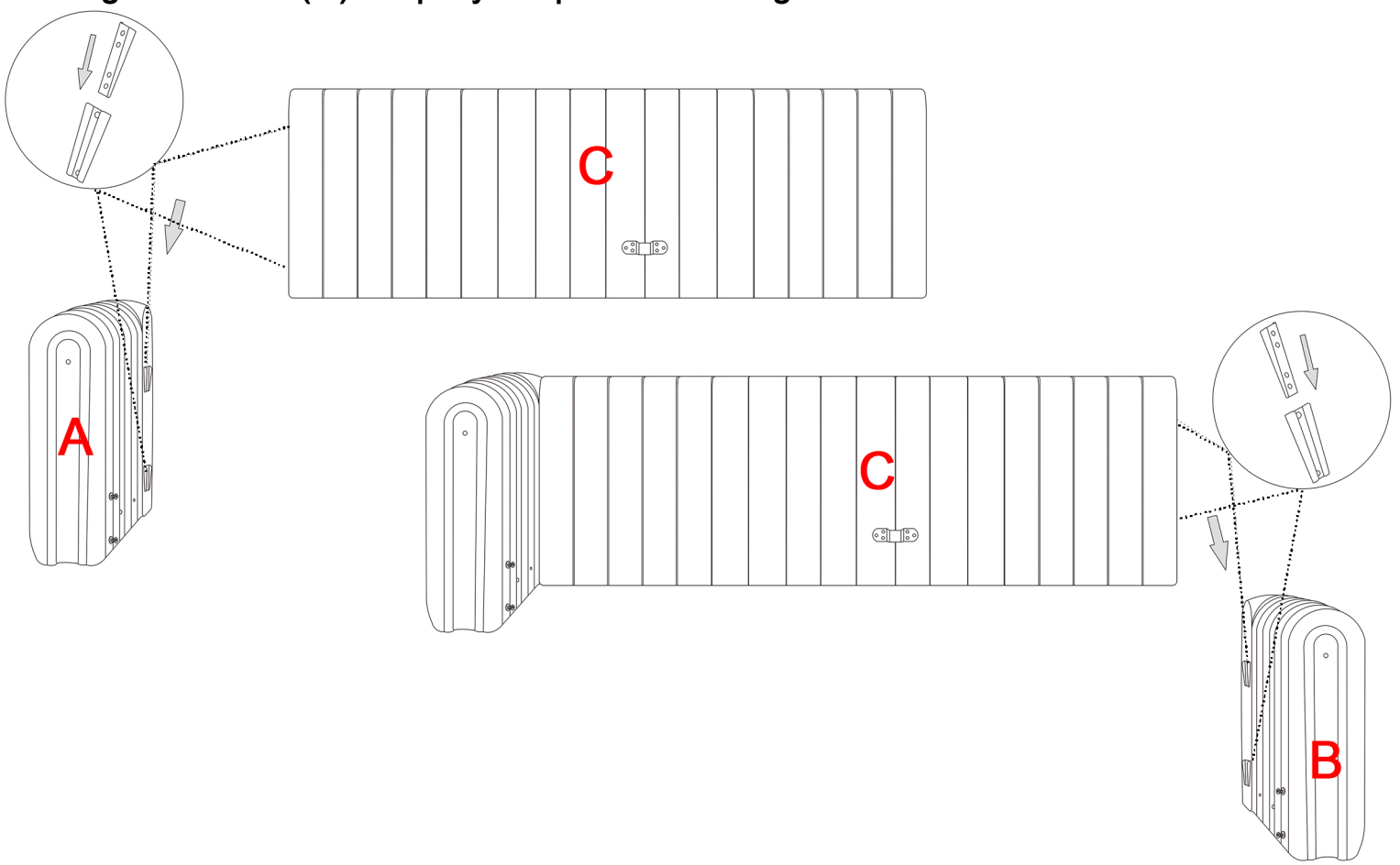

Step 2. Install the bracket(J) and (K) to each side of the front board(F)

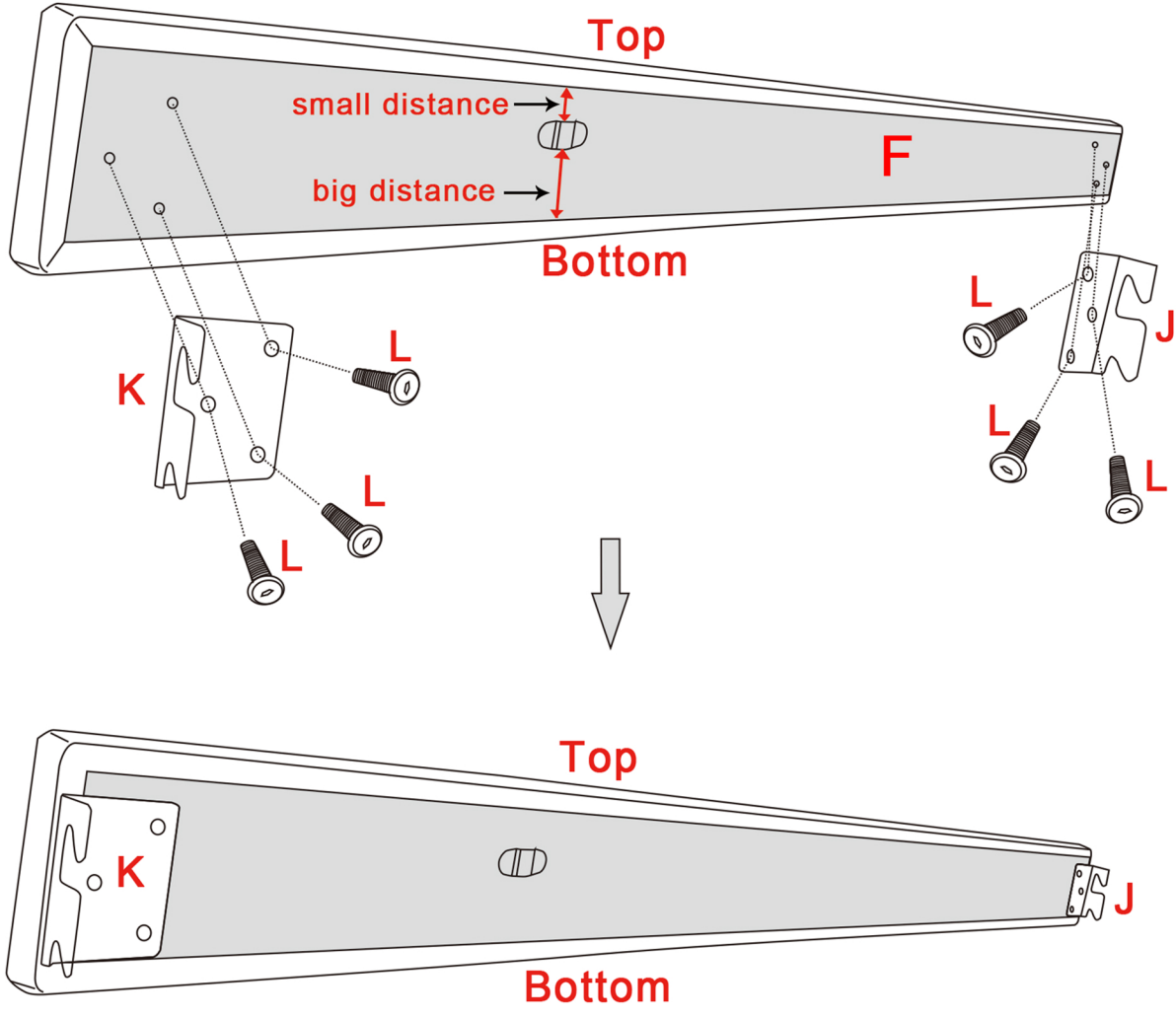

Step 3. Install the front board(F) and fasten to both armrest(A) and (B).

1) unscrew the bolt 50%

2) each bracket hook into the bolts

3) tighten the bolts

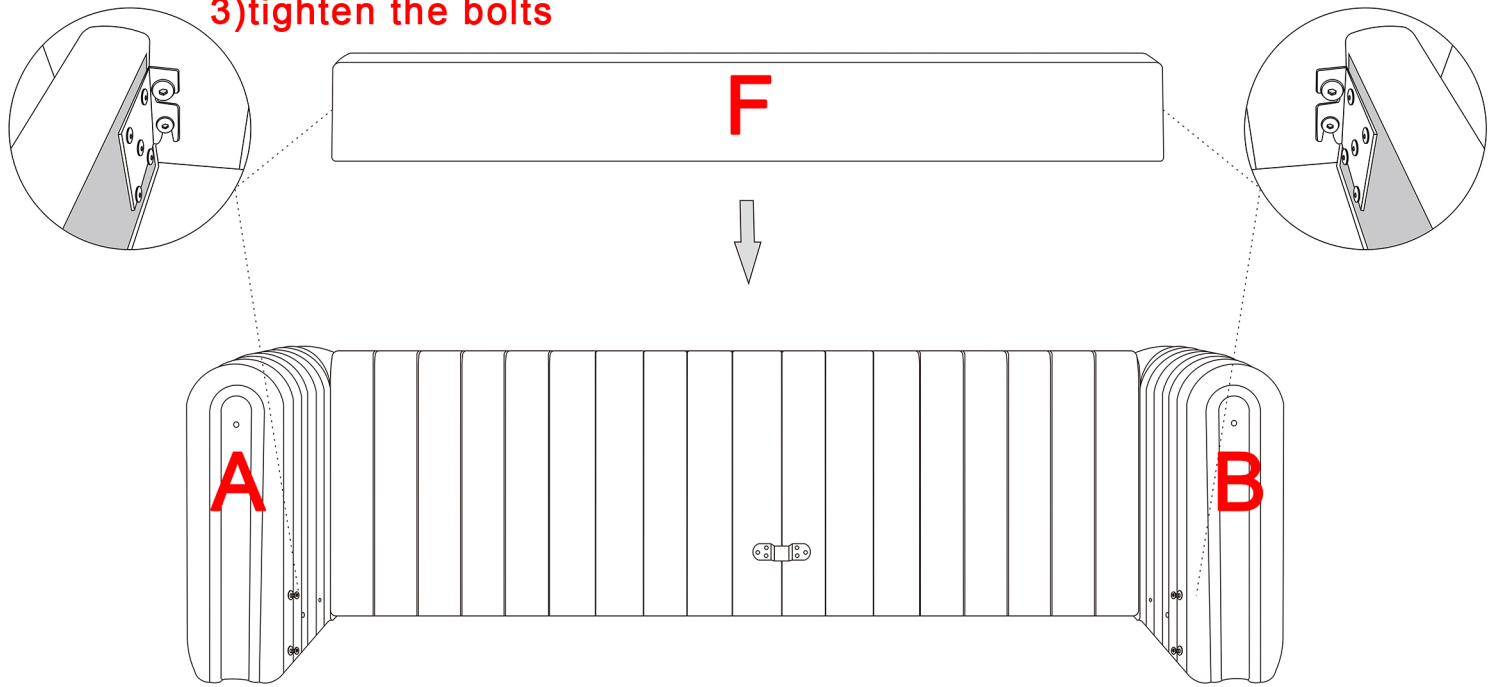

Step 4. Install the side bar(I) to both armrest(A) and (B).

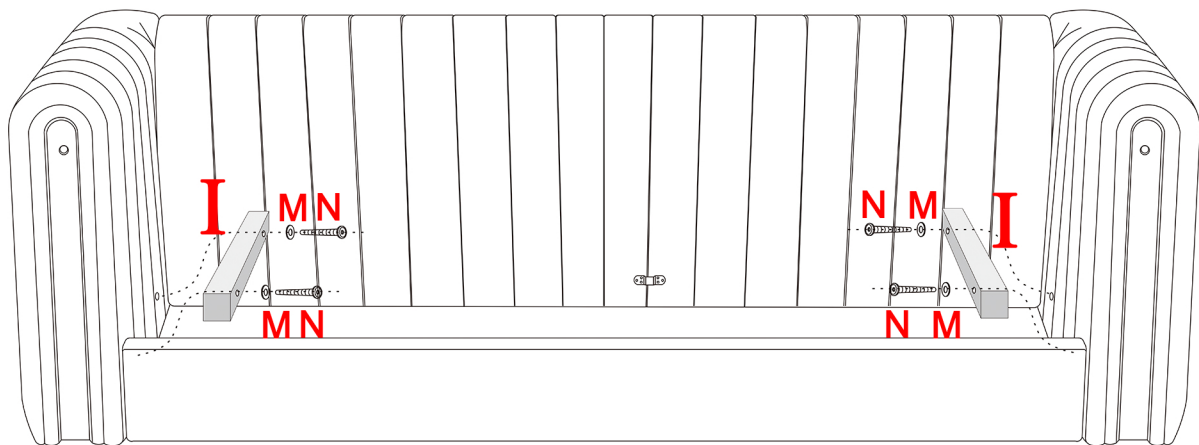

Step 5. Install the mid bar(H) between the front board(F) and sofa back(C).

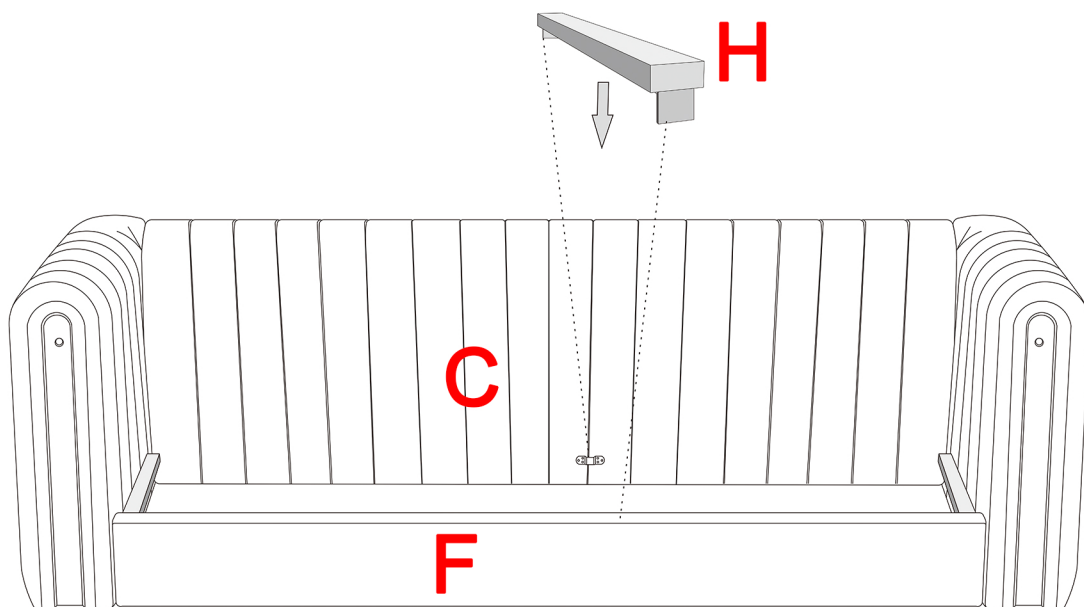

Step 6. Install the mid leg(P) on the seat board(E), and adjust the height of the mid leg, then put the seat board on top of the mid bar and side bar.

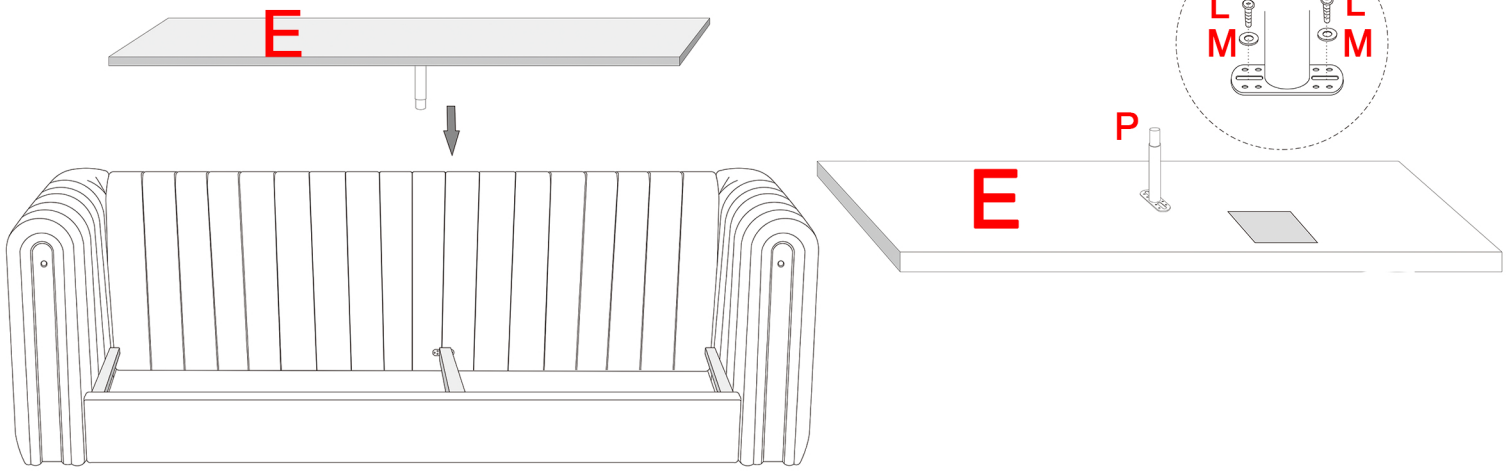

Step 7. Install the legs(G) step by step as following.

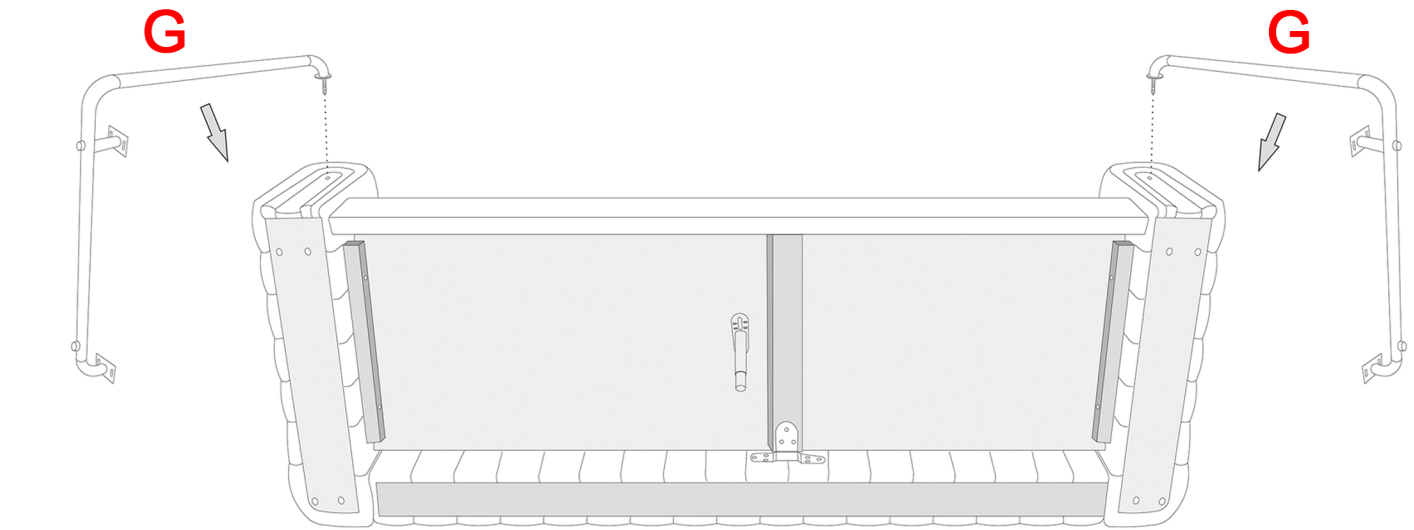

① ↓

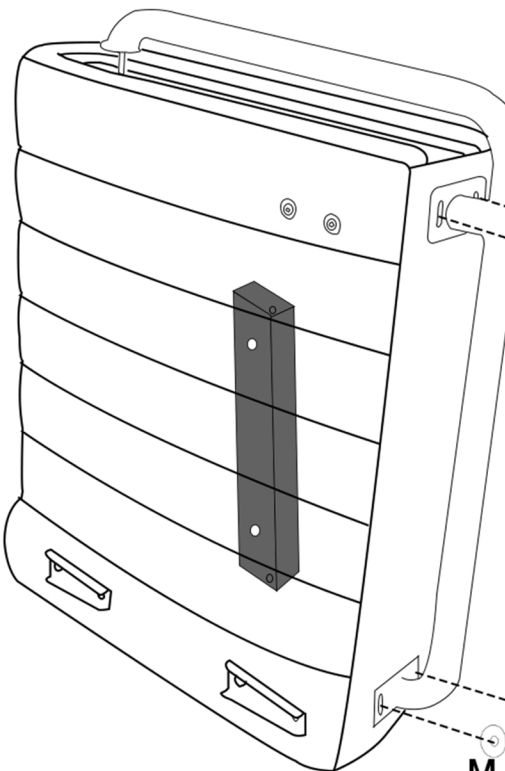

- ① insert the long bolt into the hole first.
- ② Push the metal leg from the bottom up until there is no space at the bottom.
- ③ tighten the screws.

② push the leg

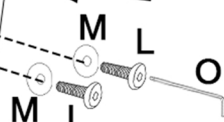

③ screw the bolts

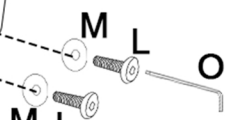

③ screw the bolts

Step 8. Put the seat cushions on top of the seat board.

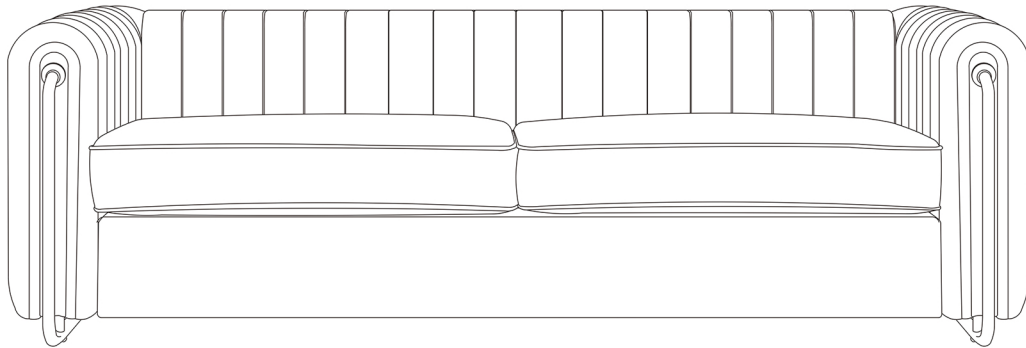
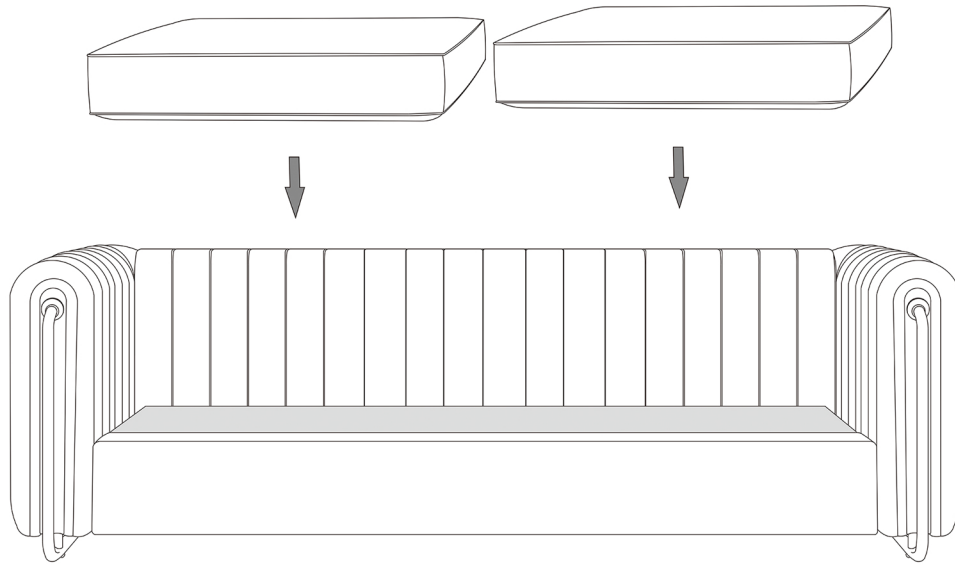

How to install the cushions

Step 1. Open the plastic bag and remove the cushions foam wrapped with polyester fiber&Non-woven bags from the plastic bag.

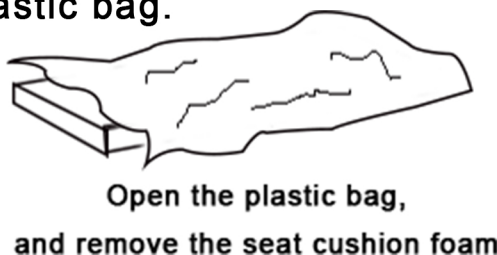
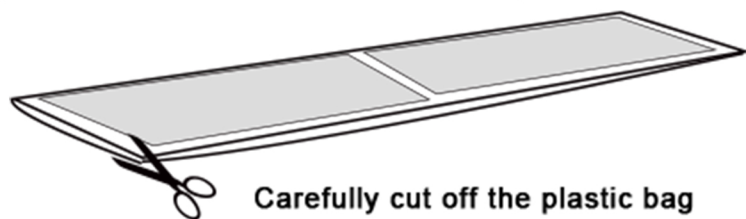

Step 2. Cover the fabric covers to all seat cushions. **PLEASE DON'T REMOVE THE NON-WOVEN BAG & POLYESTER FIBER OF THE SEAT CUSHIONS, PLEASE KEEP IT AS IT IS.** When you get the seat cushion, you will see the RED words which side is the **Top**, **Front** and **Back** as following.

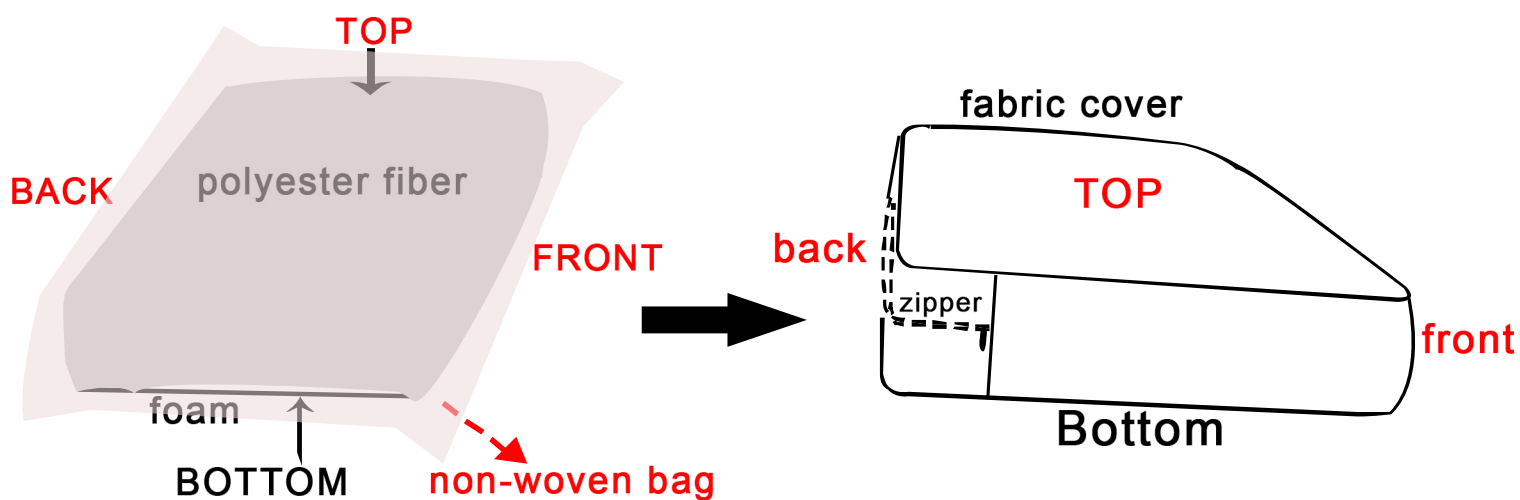

How to tidy sofa seat cushion?



TIPS

At the beginning all cushions are a little loose which is normal. Please allow at least 72 hours for all cushions foam to recover to its natural state after covering the fabric covers.