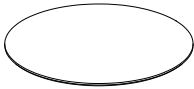

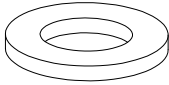
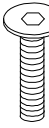



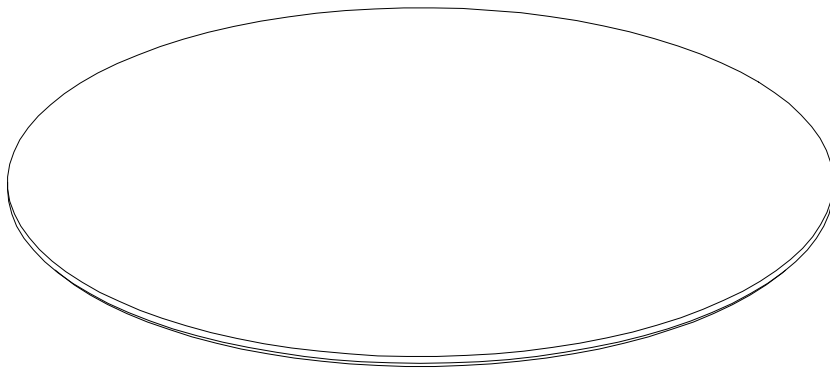

Diagram illustrating assembly steps and safety warnings:

- Top Step:** Shows an L-shaped bracket being inserted into a hole. A power drill is shown with a diagonal line through it, indicating it should not be used. A warning triangle with an exclamation mark is positioned to the right.
- Time:** A clock icon is shown below the top step, with the text "20'" below it, indicating a 20-minute assembly time.
- Bottom Step:** Shows a rectangular block being placed on a surface. A diagonal line through the block indicates it should not be used. A warning triangle with an exclamation mark is positioned to the right.
- Person Icon:** A stick figure icon is shown below the bottom step, with the number "1" below it, indicating that one person is required for this step.

A	B	C	D	E
			 M8 x 25	
x 1	x 4	x 16	x 16	x 1

A



B x 4

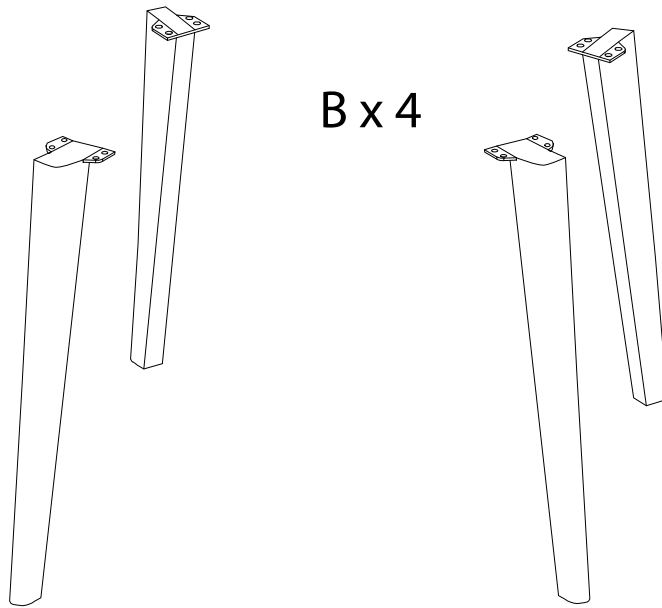

1

