

Installation manual

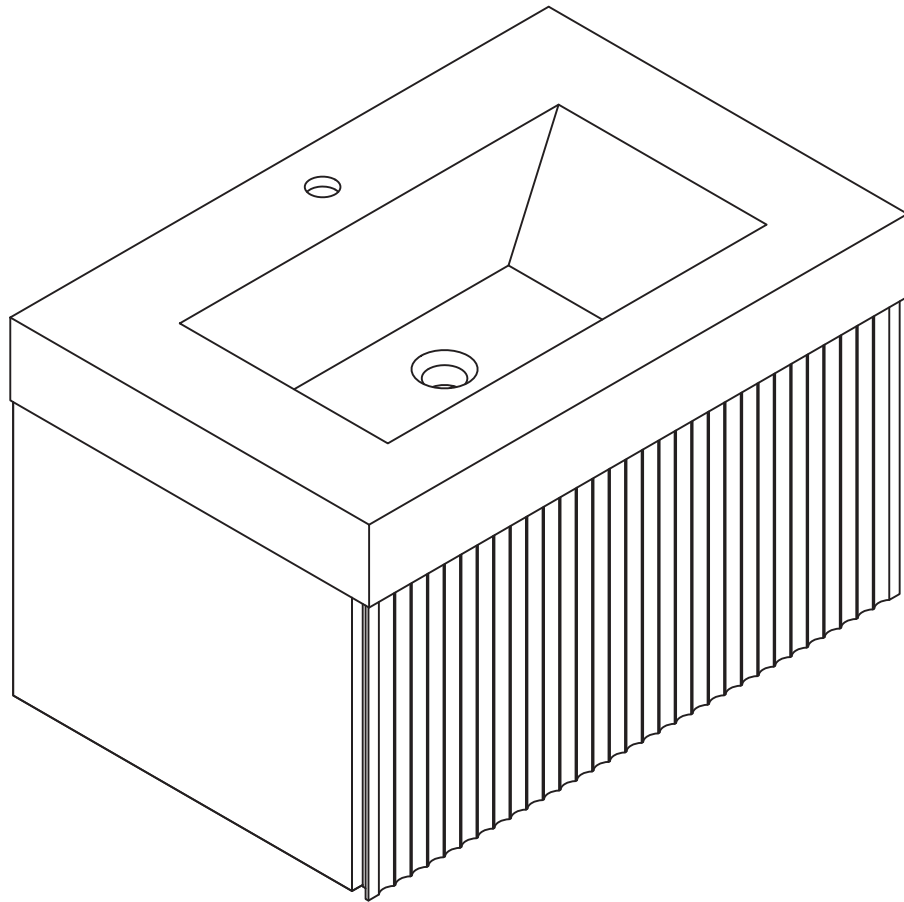

RX-V08-30NW



Thank you for shopping with us!

We encourage you to take a few minutes to go through this booklet. It contains important information on installation and care tips to keep your furniture looking as good as new.

⚠ Attention

 Prohibited	Cleaning agent with (acidic) mark	Bathroom cabinet may change color
	Cleaning agent with (alkaline) mark	
 Must be executed	1.Many cleaners contain abrasives and chemicals and cannot be used to clean stainless steel, enamel, plating or plastic products. These surfaces must be cleaned with a mild detergent or make-up solution, the residual wash is washed, and then wiped dry with a clean soft cloth	
	2.Please keep a good ventilation in the bathroom. you can dry and wet che separation. usually, keep opening the window and opening the door.	
	3.The bathroom cabinets are subjected to strict moisture-proof treatment, When using, the bathroom cabinets are not allowed to be watered or splashed. Good moisture resistance can ensure good use at high relative humidity, so please avoid the bathroom is too humid, in case of water, it should be dried in time.	
	4.Maintenance of the door panel: Regularly clean and wipe with a soft cloth. The cold water vapor after bathing should be dried with a dry cloth to keep the door panel dry.	
	5.Do not sit, lean, lean on, or step on the washbasin cabinet during daily use	



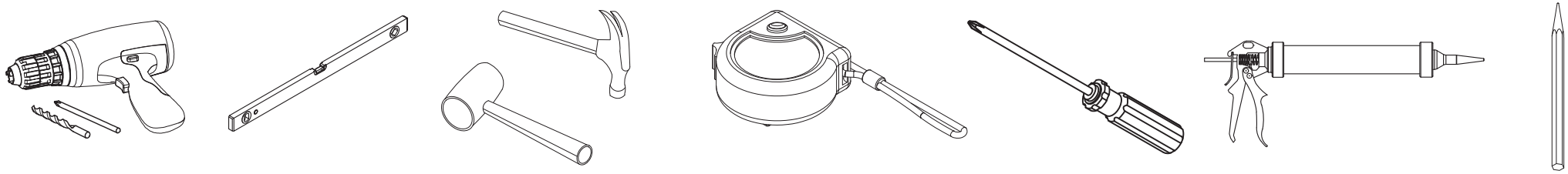

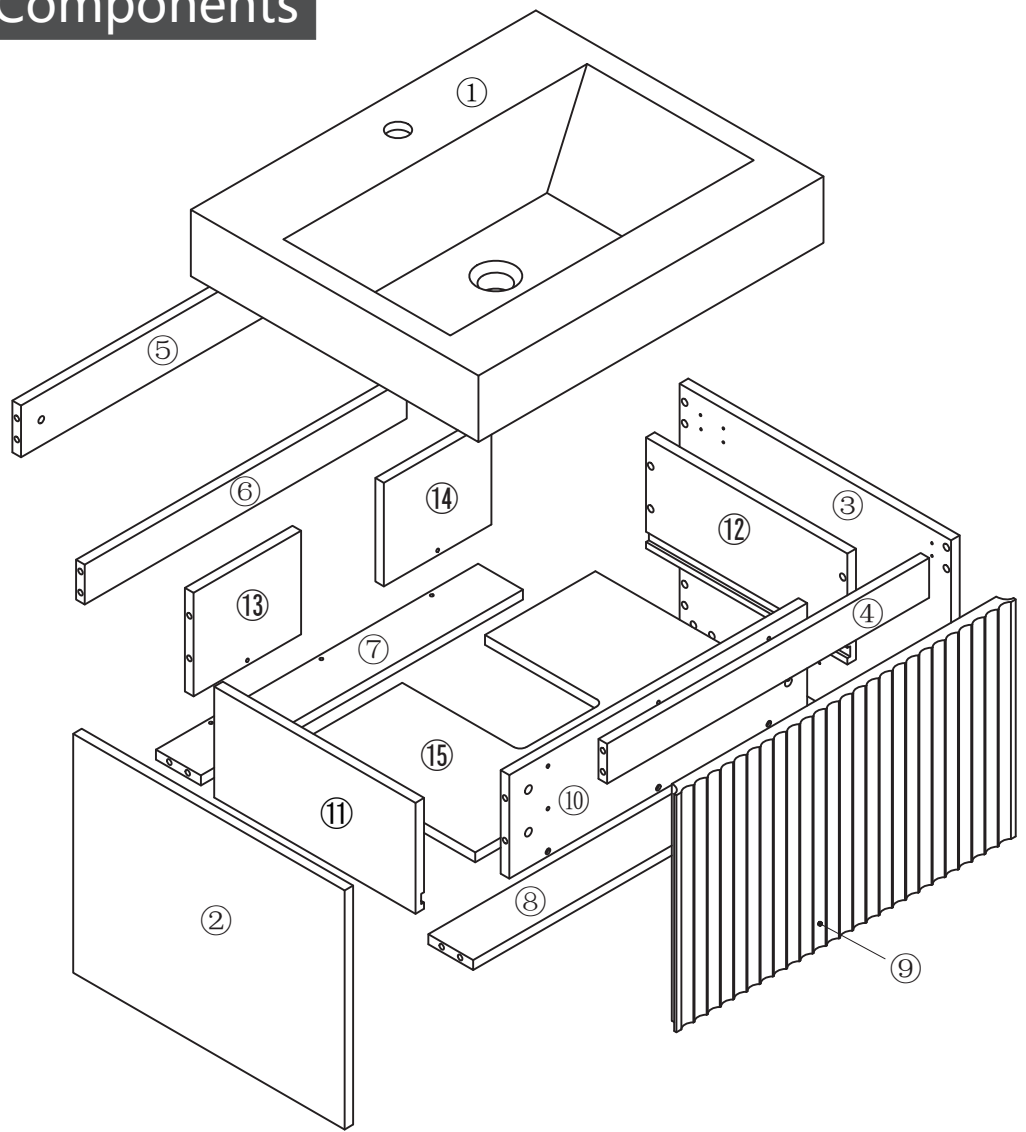

Recommended tools

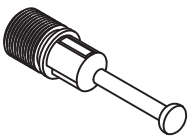

Components

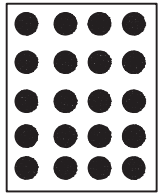
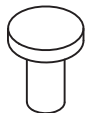

Hardware

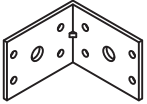
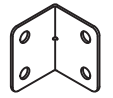
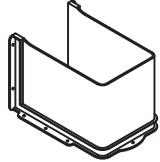
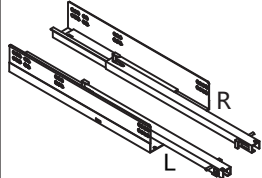
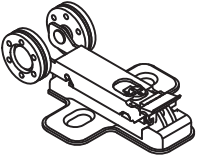
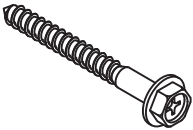
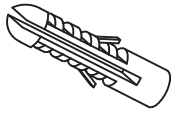
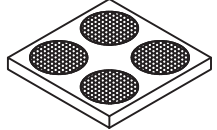
			
A=28 PCS	B=28 PCS	C=28 PCS	D=4 PCS
			
4*14mm E=45 PCS	4*25mm F=6 PCS	4*30mm G=8 PCS	H=2 PCS
			
I=2 PCS	J=1 PCS	K=1 PCS	L=2 PCS
			
M=2 PCS	N=2 PCS	O=4 PCS	

Step 1

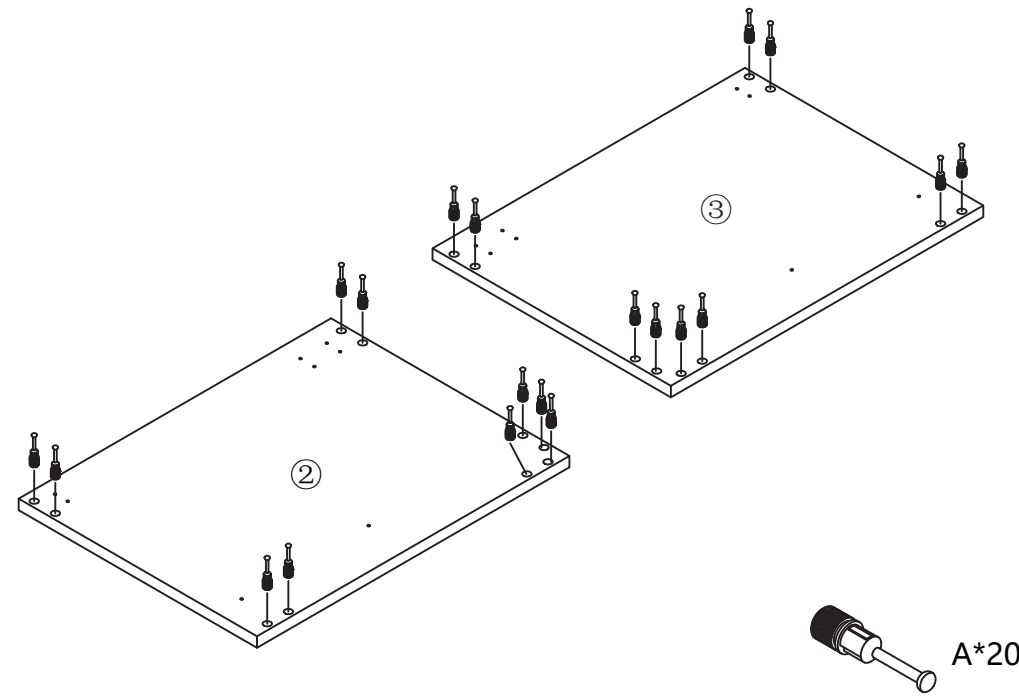

Step 2

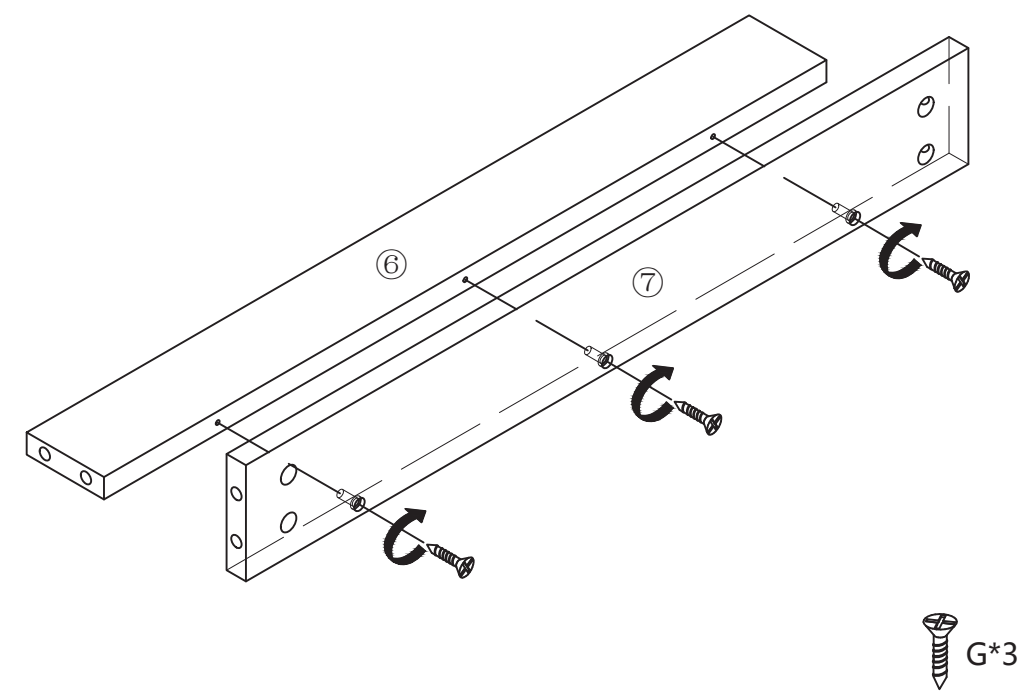

Step 3

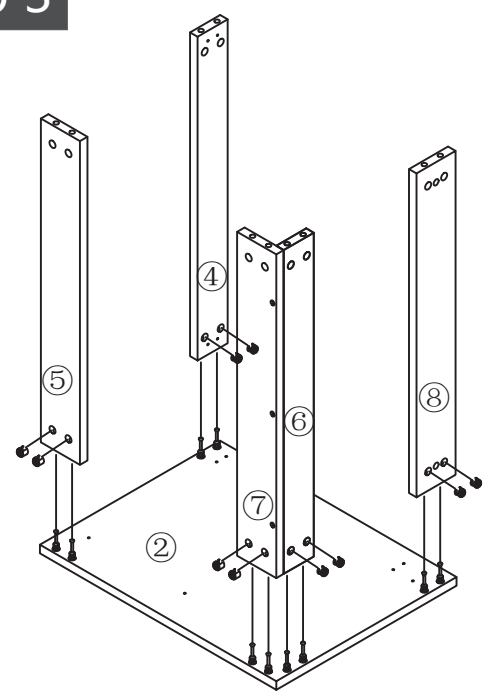

first step

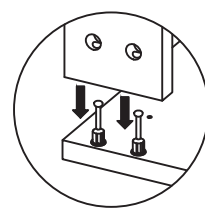

second step

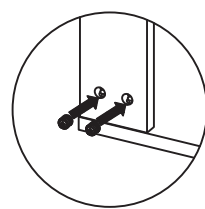

third step

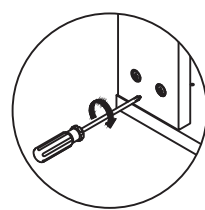

Step 4

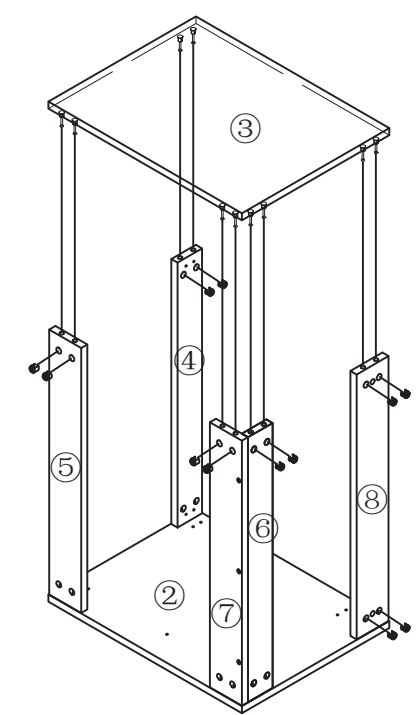

Step 5

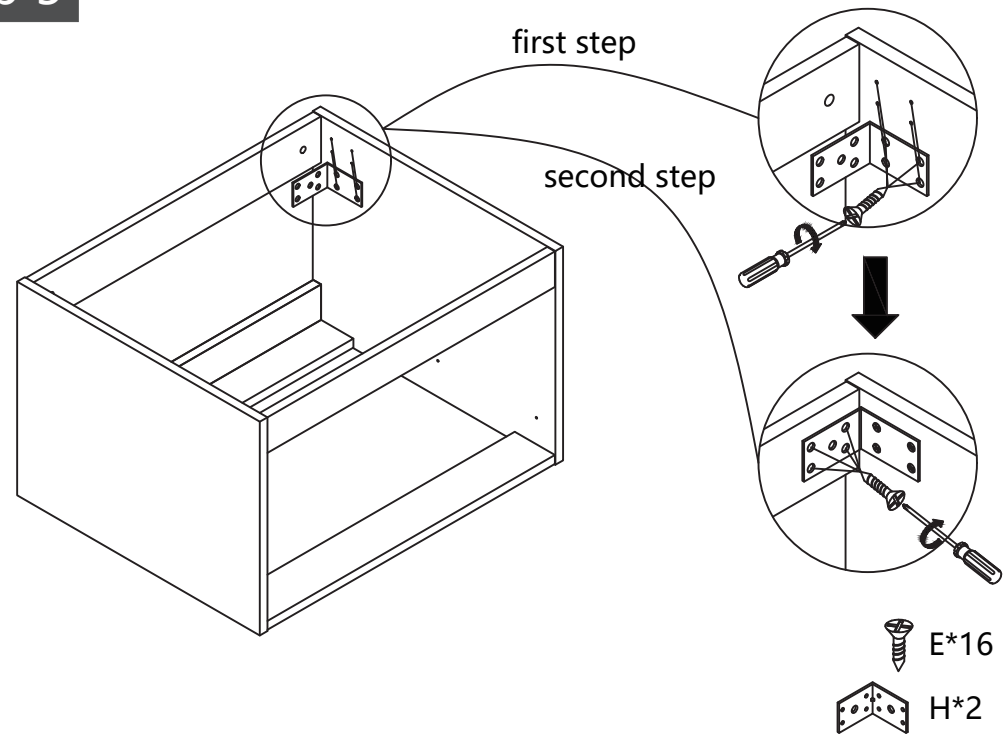

Step 6

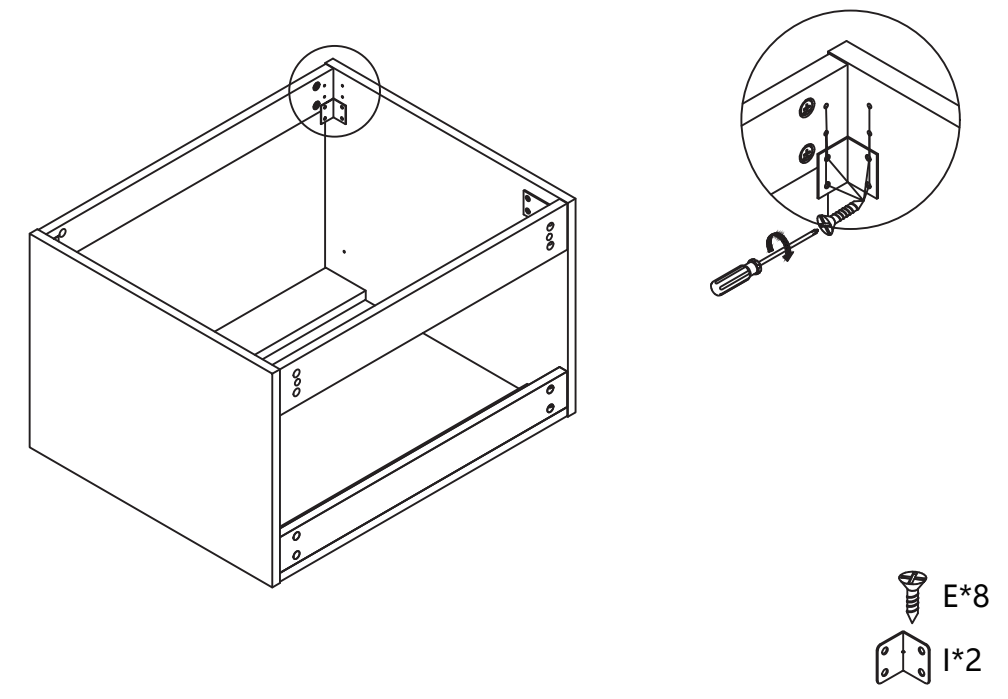

Step 7

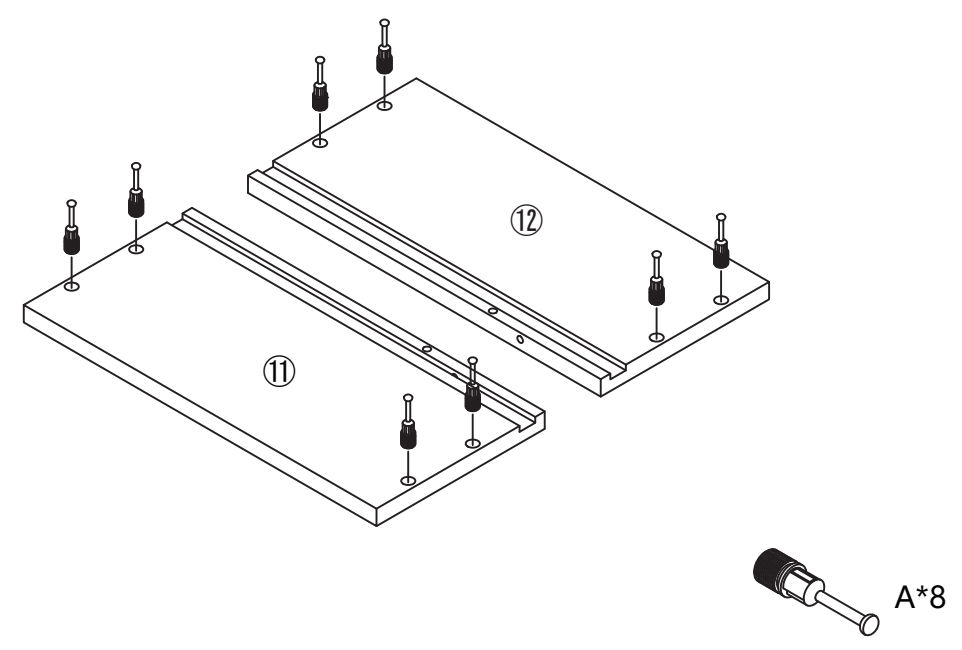

Step 8

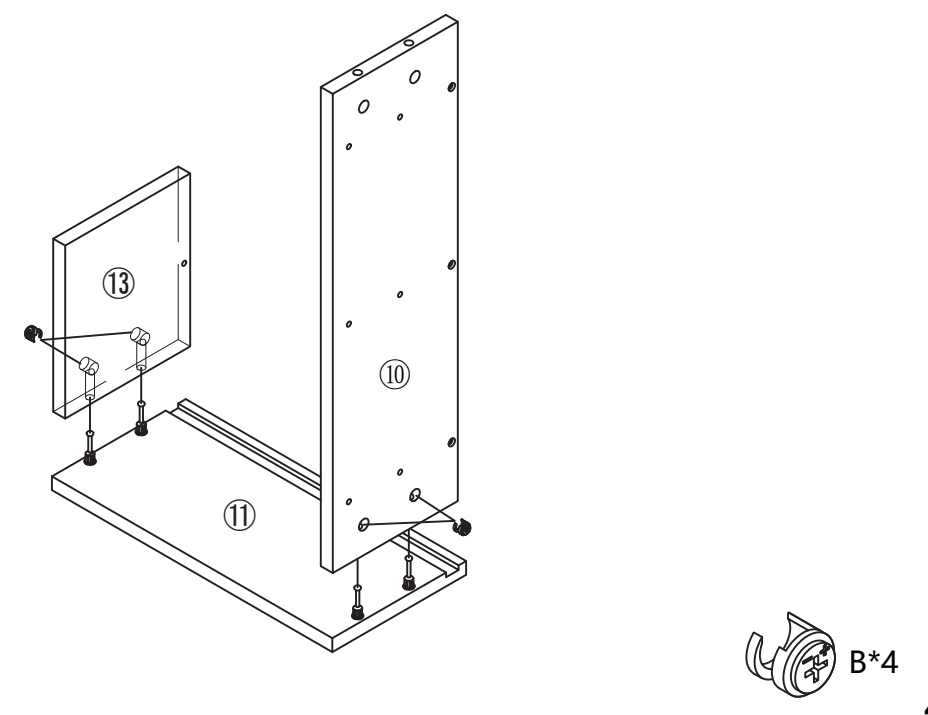

Step 9

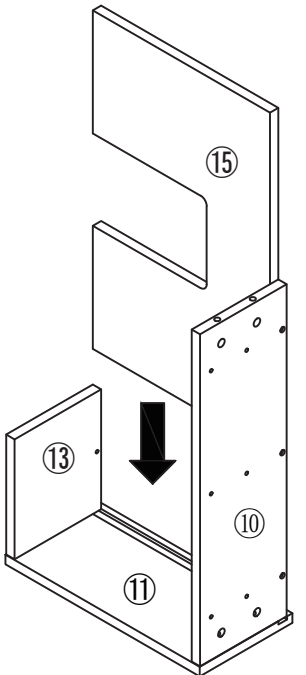

first step

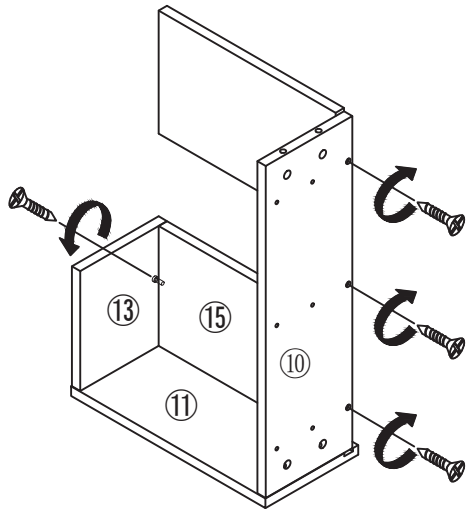

second step



Step 10

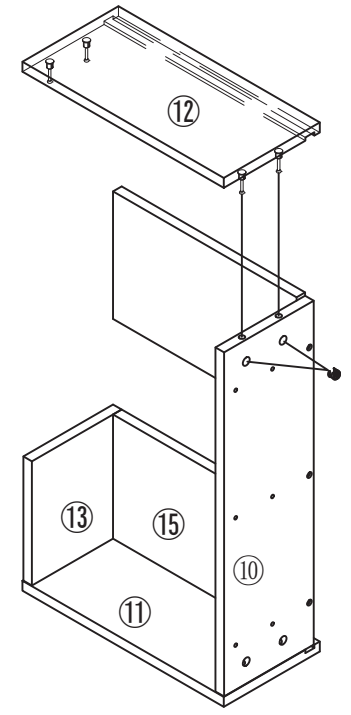

Step 11

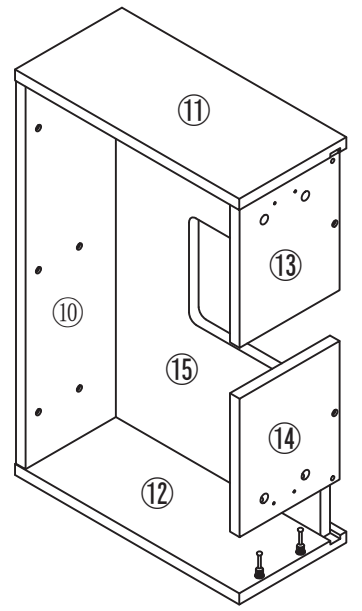

first step

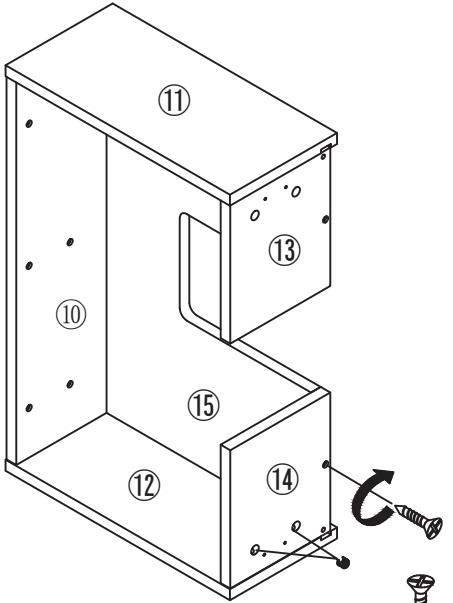

second step

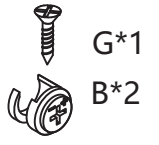

Step 12

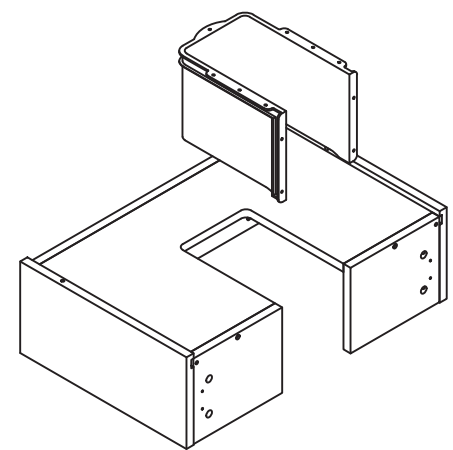

first step

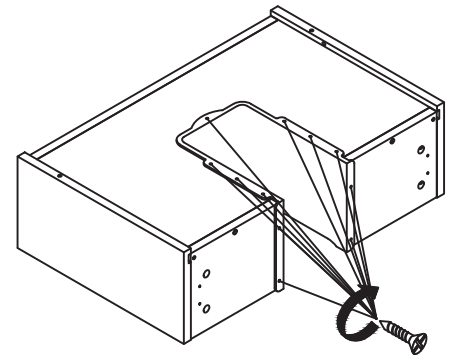

second step

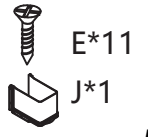

Step 13

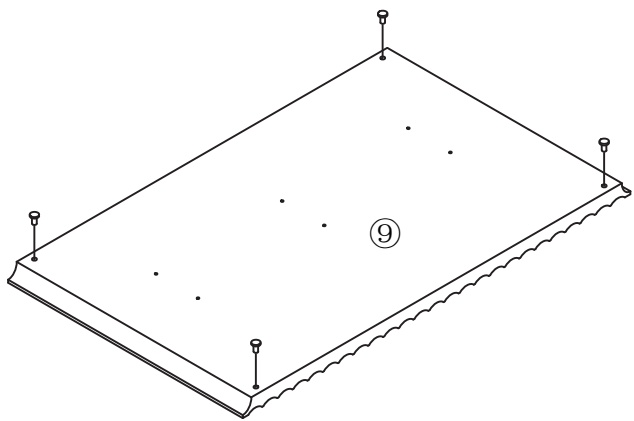

D*4

Step 14

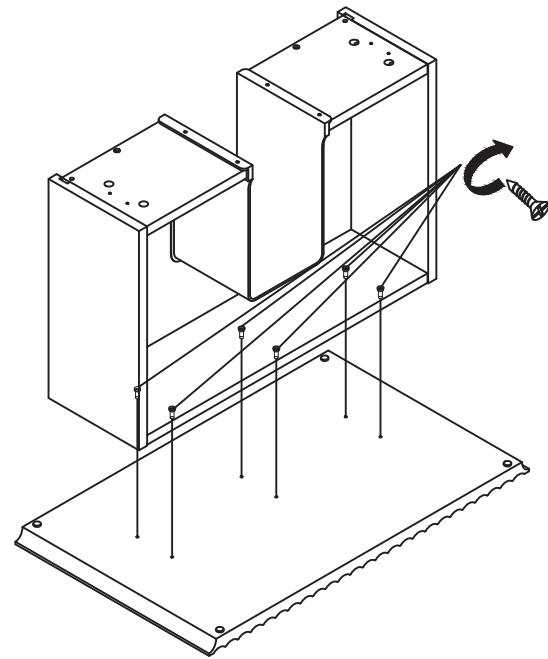

F*6

Step 15

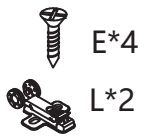
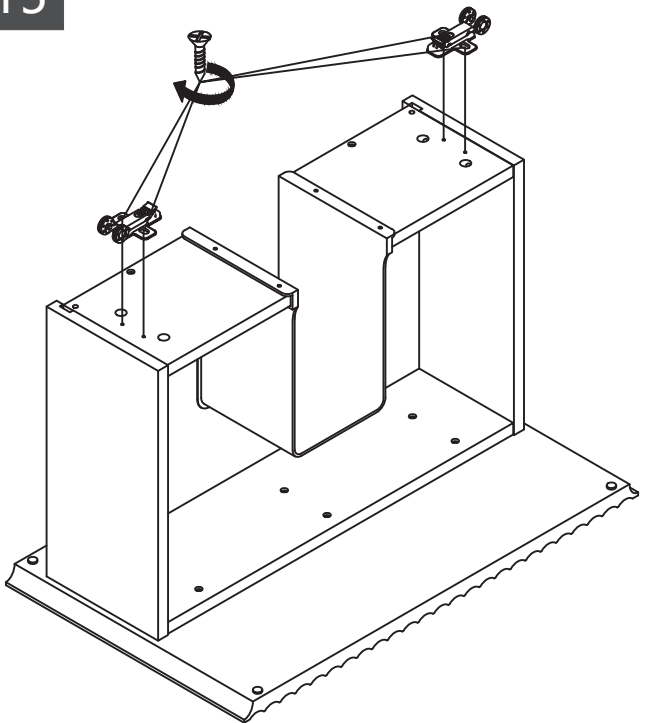

E*4

L*2

Step 16

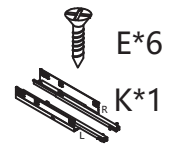
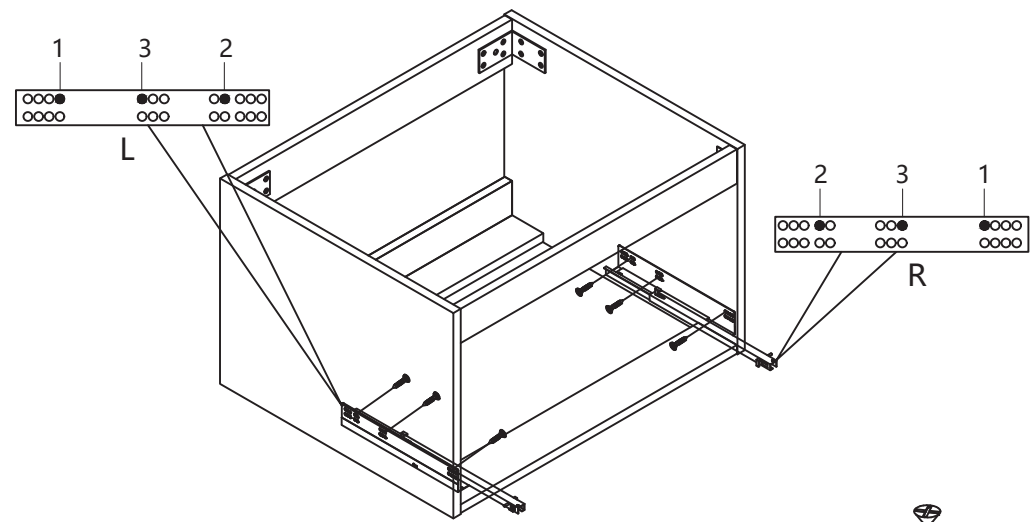

E*6

K*1

Step 17

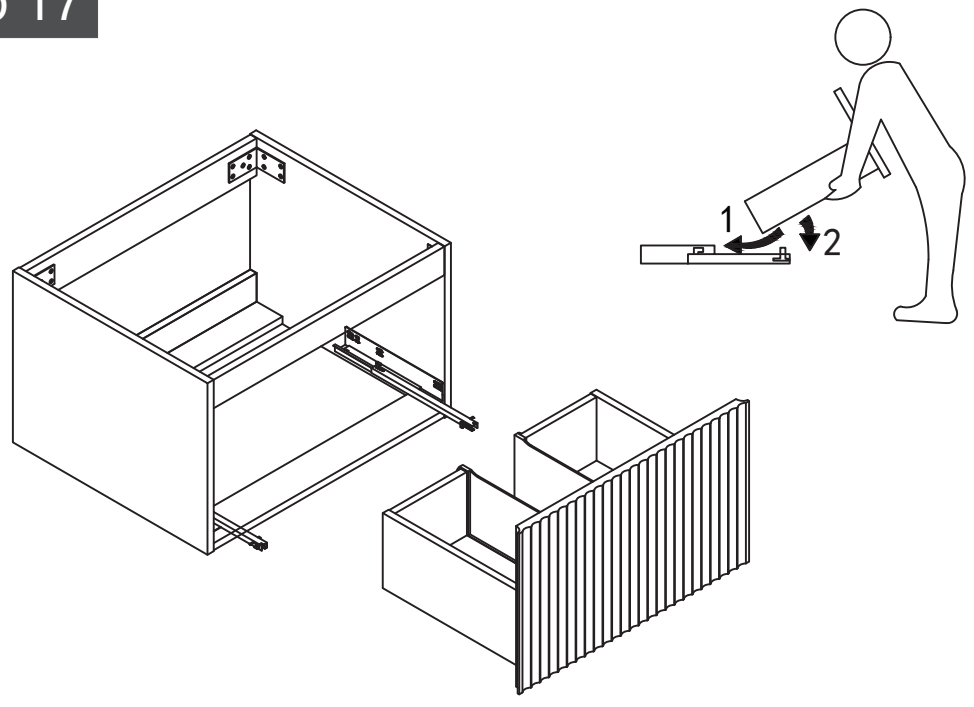

Step 18

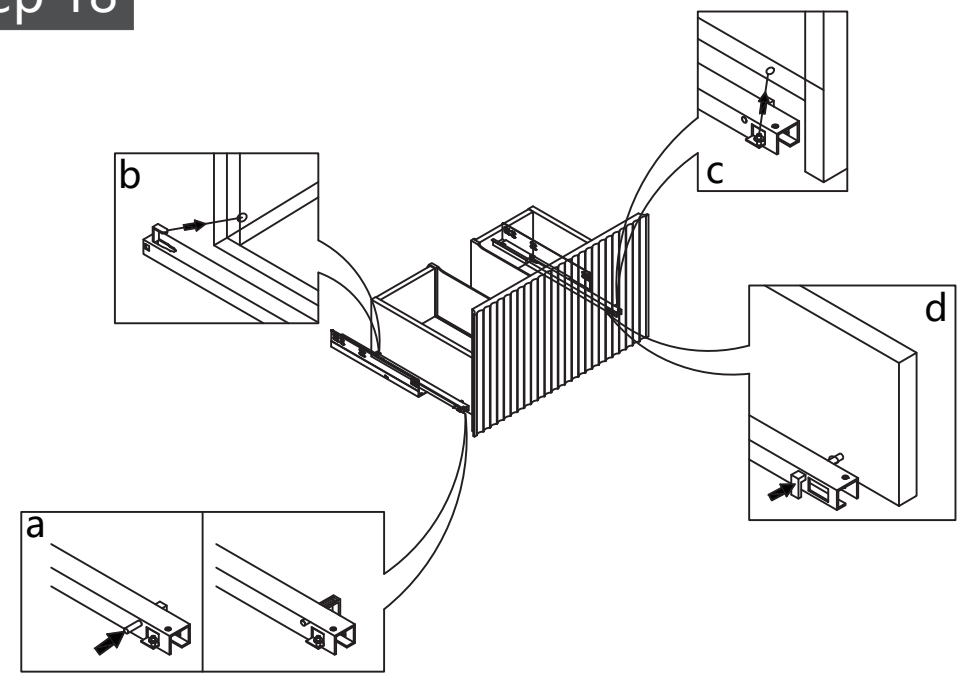

Step 19

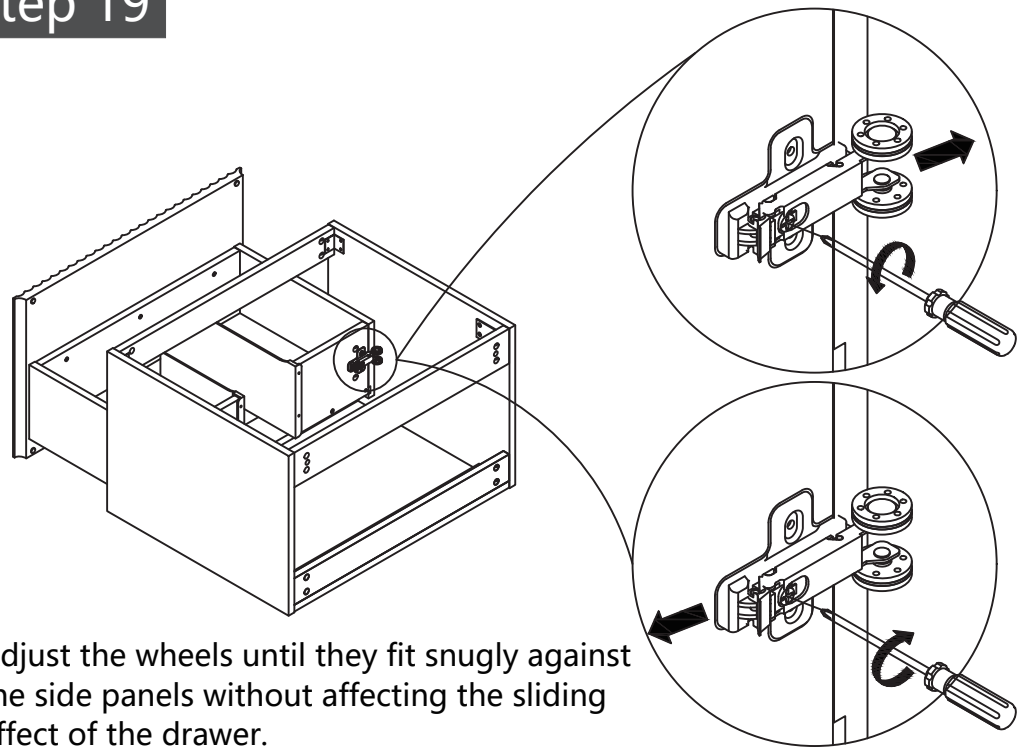

Adjust the wheels until they fit snugly against the side panels without affecting the sliding effect of the drawer.

Step 20

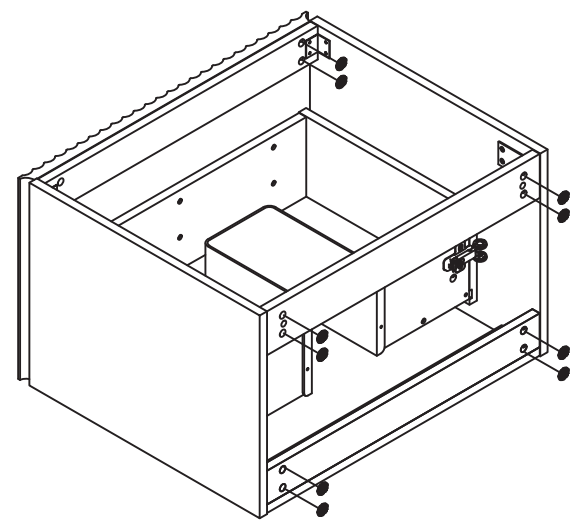

Step 21

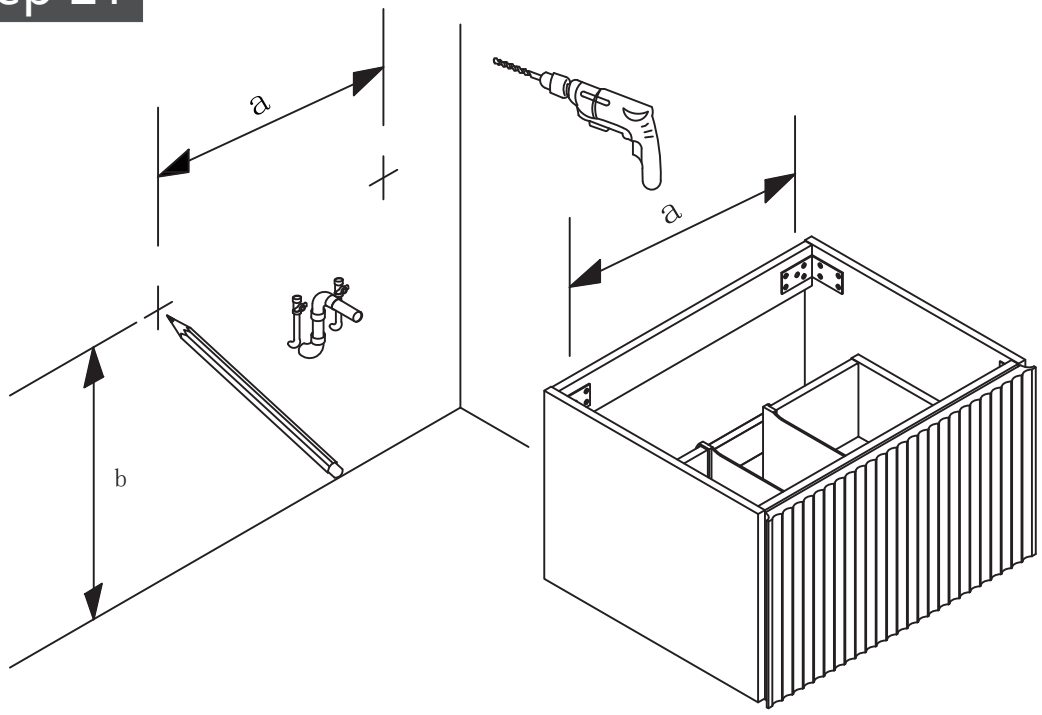

Step 22

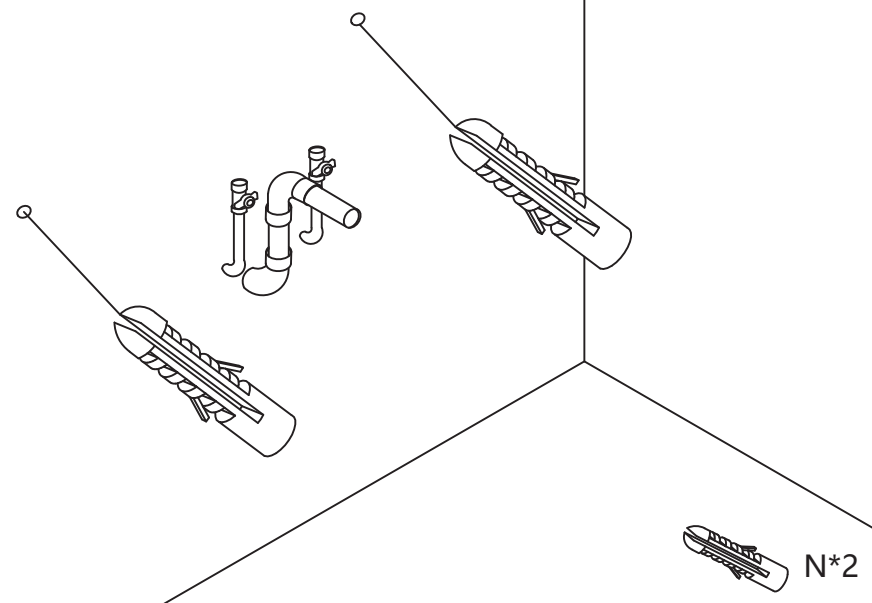

N*2

Step 23

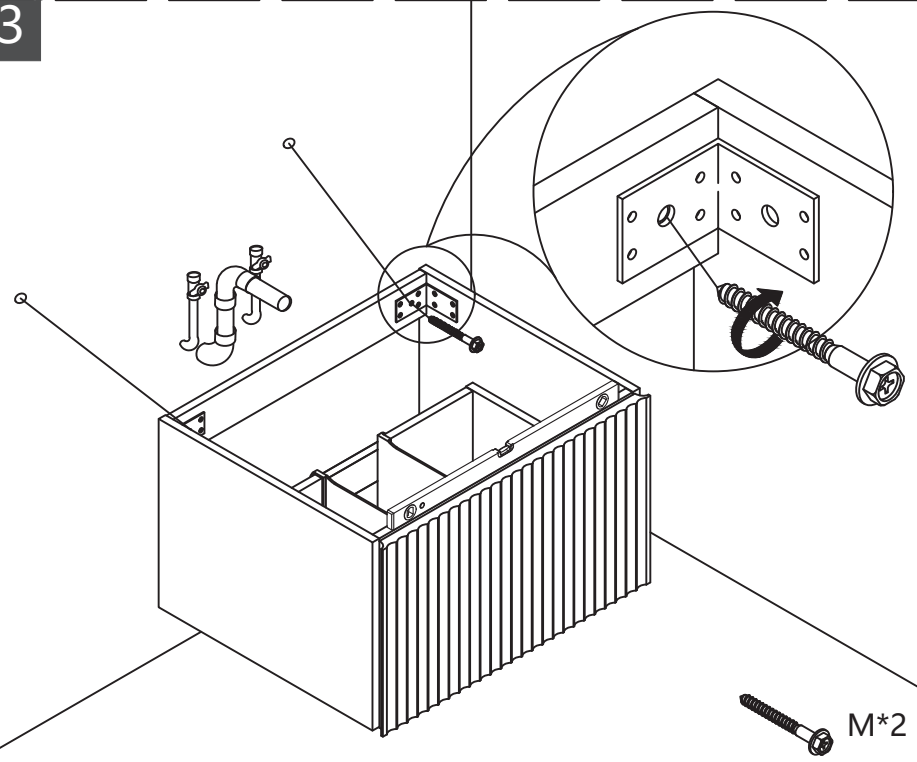

M*2

Step 24

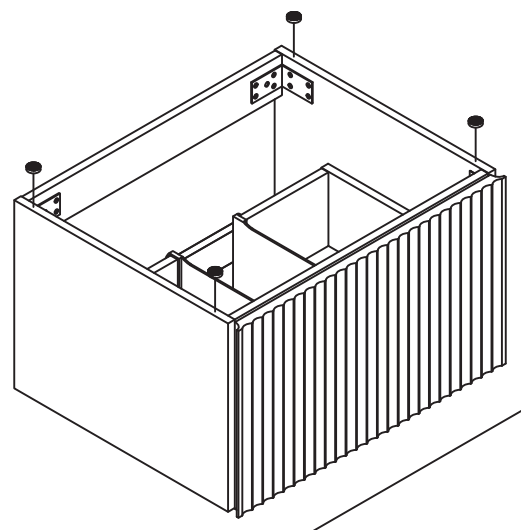

O*4

Step 25

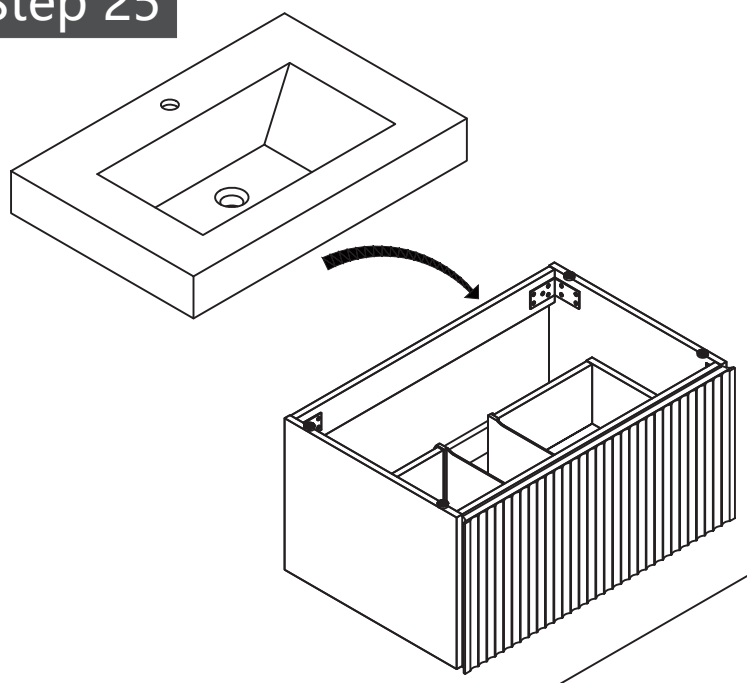

Step 26

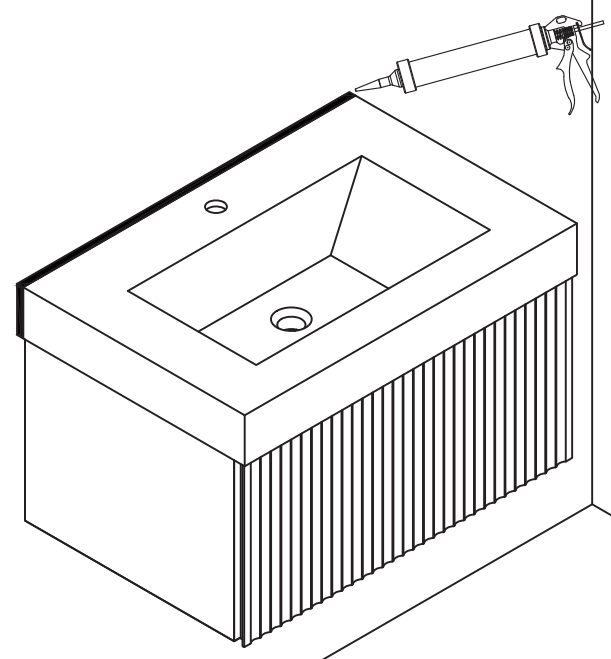

OK

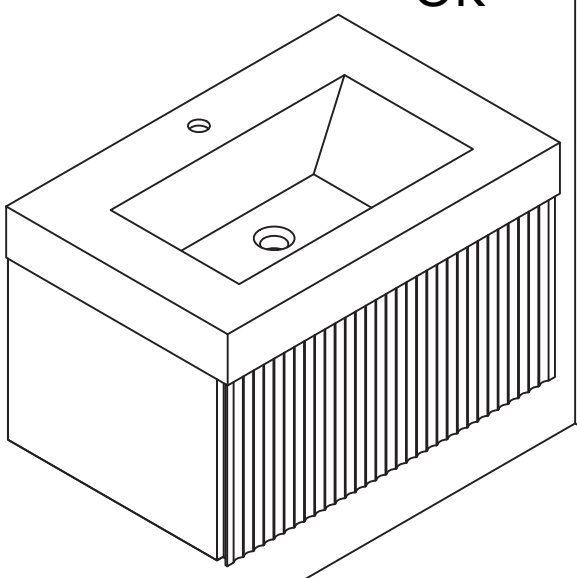

THANKS FOR WATCHING

Your feedback is invaluable to us and we would love to hear about your experience. Please take the time to leave us a review.