

STORE CONTENT ARK

INSTALLATION MANUAL

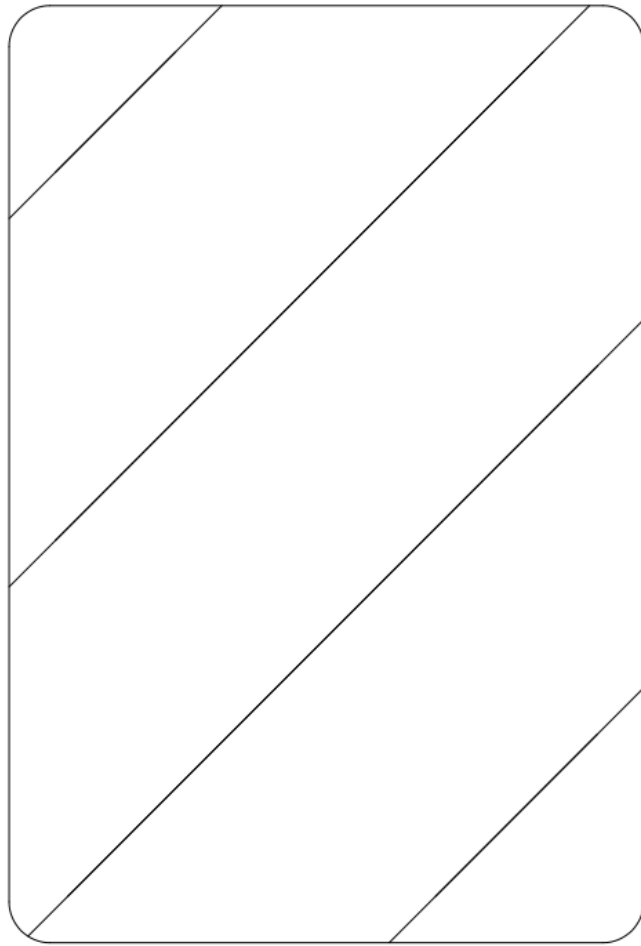

01 /Parts List

LIST OF PARTS

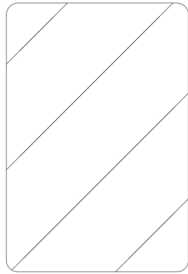

Mirror Cabinet X1

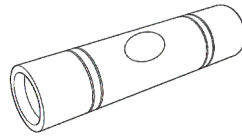

Spirit Level X1

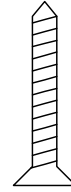

①Screws X4

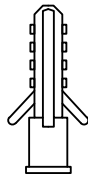

②Anchors X4



③Shelf X4



④Screw Cover X4

TOOLS NEEDED(Not Provided)

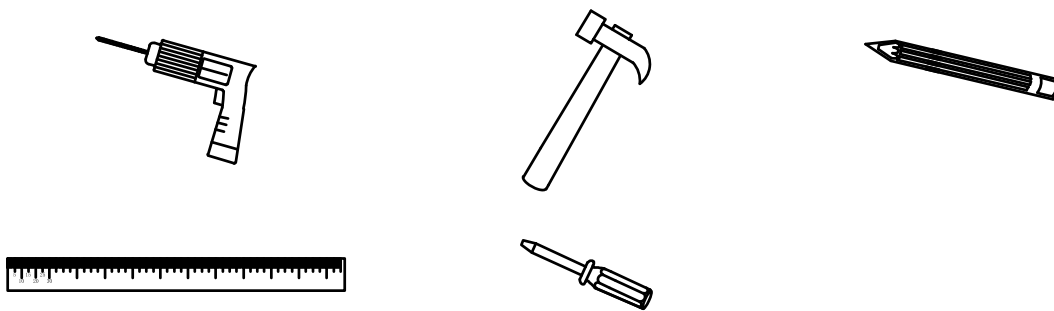

ROUGH WALL OPENING

Overall Size	Rough Wall Opening (minimum Inside Diameter)
24in.(W)x 36in.(H)x5.3in.(D)	21.6in.(W)x 33.4in.(H)x4.1in.(D)

02/Installation Steps

▲ IMPORTANT

1.This product contains glass parts.Care must be taken when fitting or handling these parts to prevent personal injury or damage to the Products; if the glass is broken, please stop using it and replace it from agent or manufacturer.

2.Care must be taken before drilling fixing holes to avoid any existing wiring or pipework that may be concealed; Finish the installation as following steps

MAINTENANCE CLEANING

Cabinet(s) should only be cleaned with clean chamois leather moistened with warm water and given a final polishing buff with a soft,lint free cloth.

03/Recessed Installation

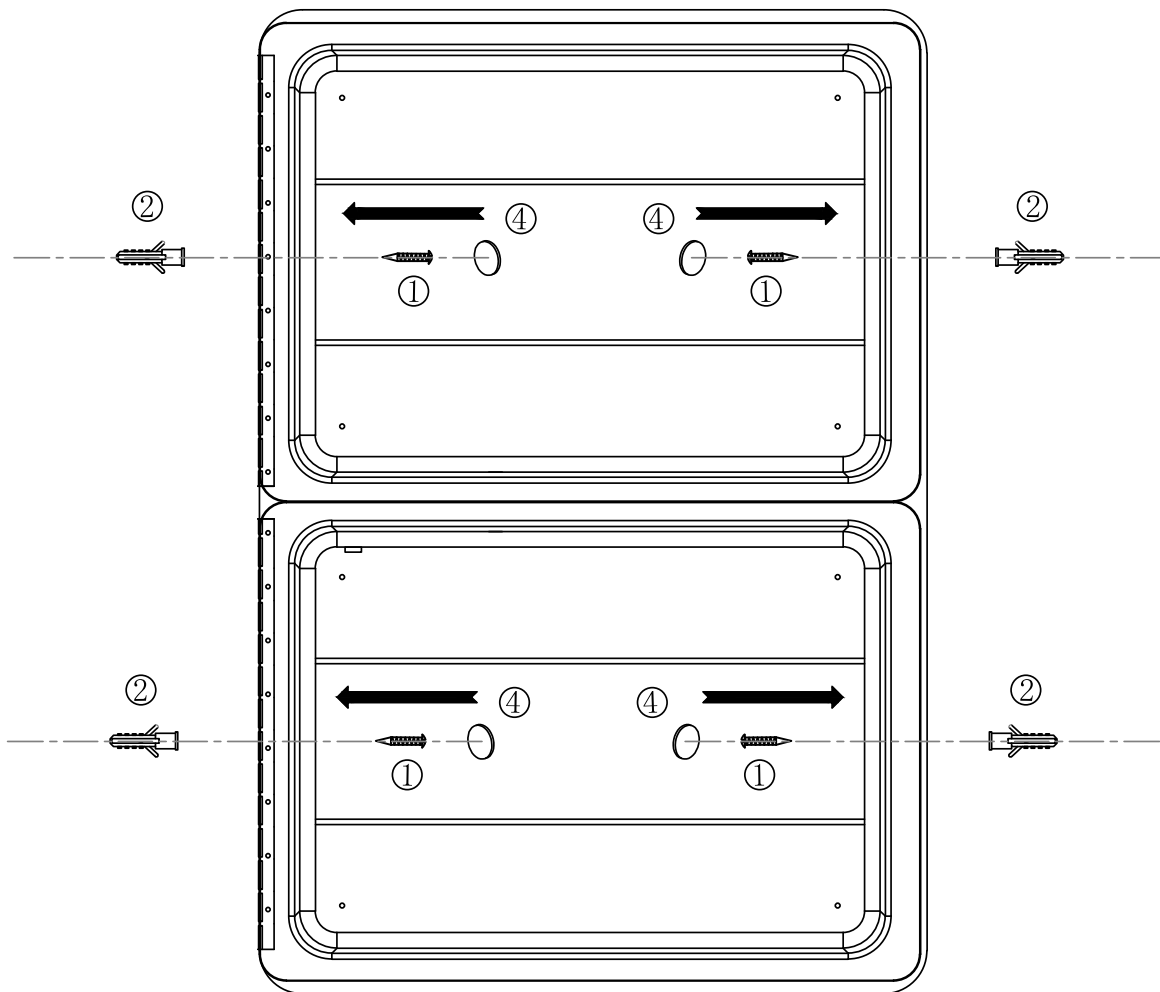

Step 1. Carefully remove all packing material. Place shelves and hardware aside until needed.

Step 2. Determine desired location of cabinet on wall. Mark wall to show wall opening size. Generally, the recommended height to the center of the cabinet is 64" from the floor.

Step 3. CAUTION: Wall studs, plumbing or electrical lines that interfere must be removed or relocated. Cut wall opening, being careful not to damage the surrounding wall surface. Insert framing to support all plaster board edges.

03/Recessed Installation

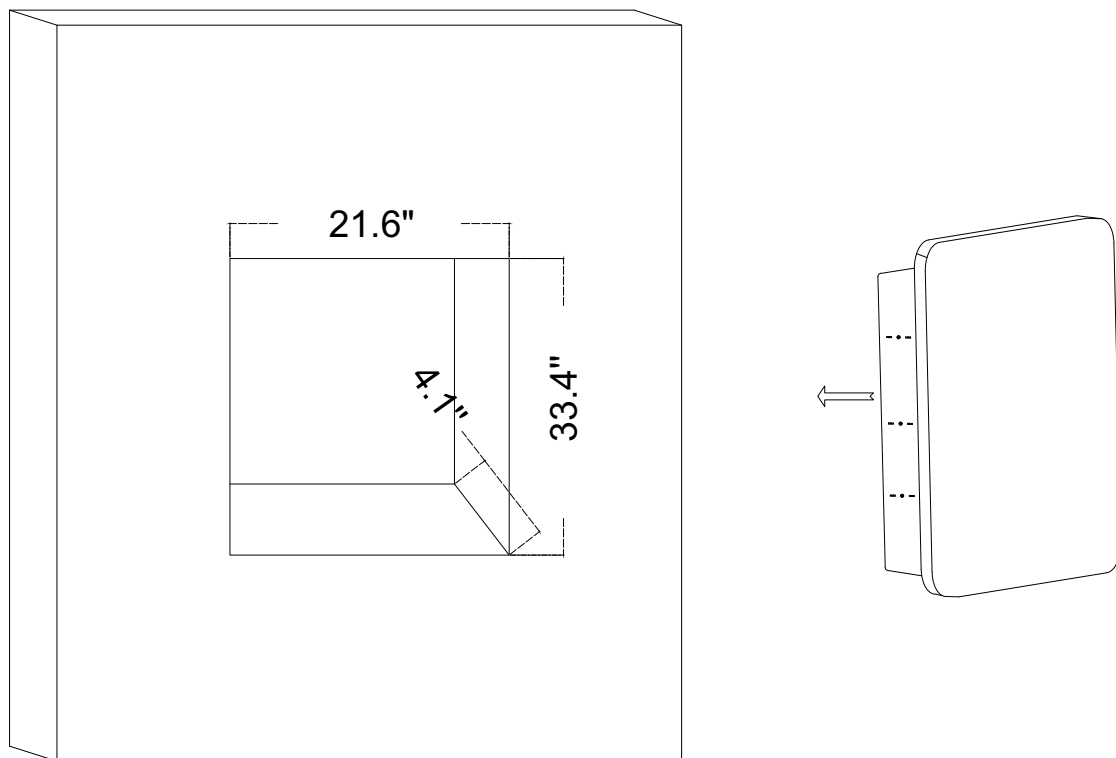

Step 4. Insert cabinet into wall opening in plumb and centered position. Use a carpenter's level and shim corners of cabinet if necessary. Place the level on the object you want to measure, ensuring good contact between the level and the object. Then observe the position of the bubble. If the bubble is in the middle, it indicates that the object is level.

Step 5. Once cabinet is inserted into wall, measure down 4.3" from the top and the bottom of the cabinet. Center the measurement on the sides of the cabinet.

Step 6. Using a drill bit, drill a total of 4 pilot holes in the locations determined in Step 5. Secure to wall studs through the 4 mounting holes inside cabinet (screws provided)

04/Surface Installation

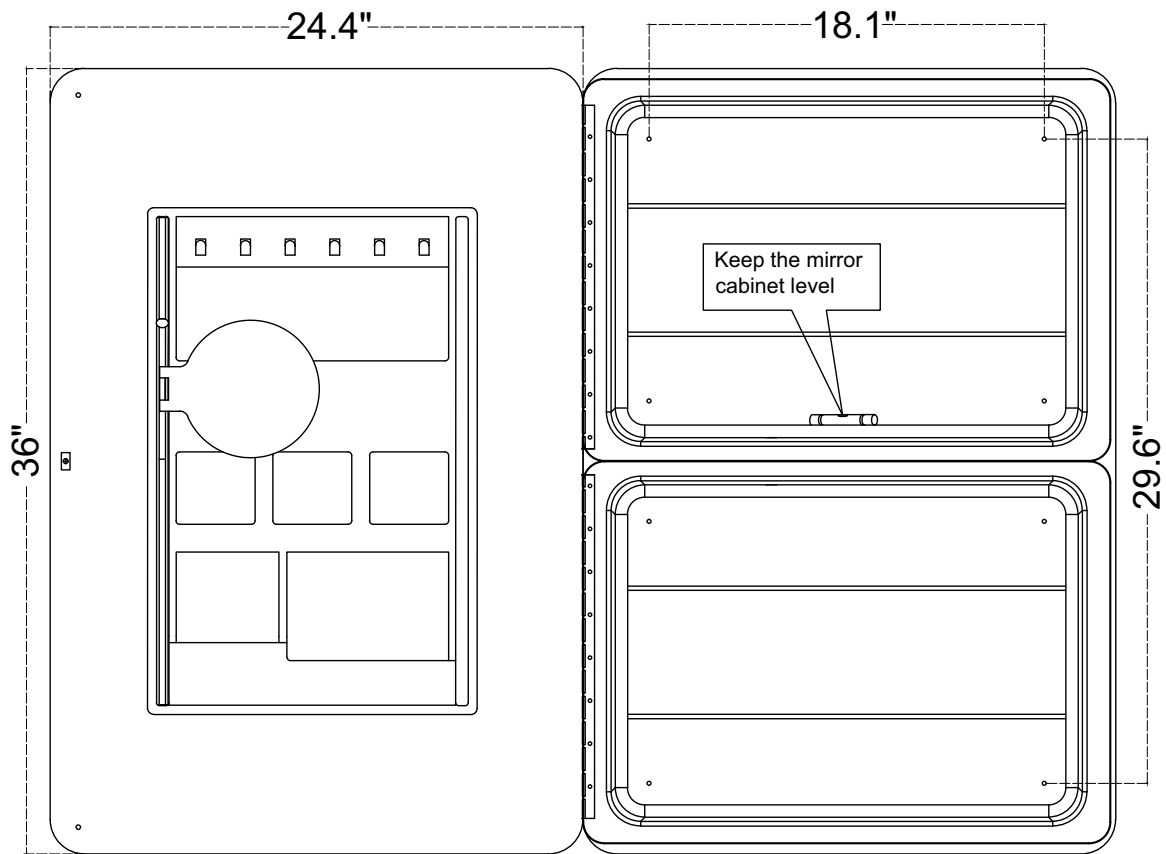

Step 1. Open the door and measure four (4) mounting holes

04/Surface Installation

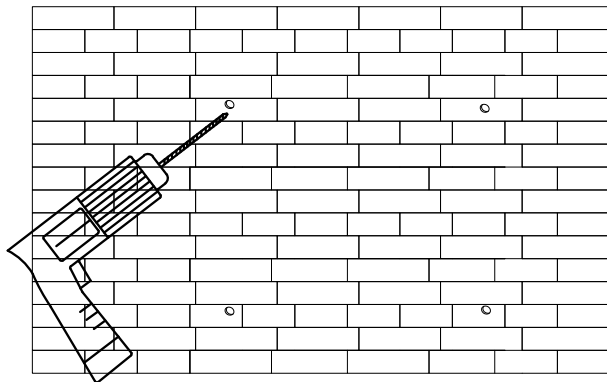

1

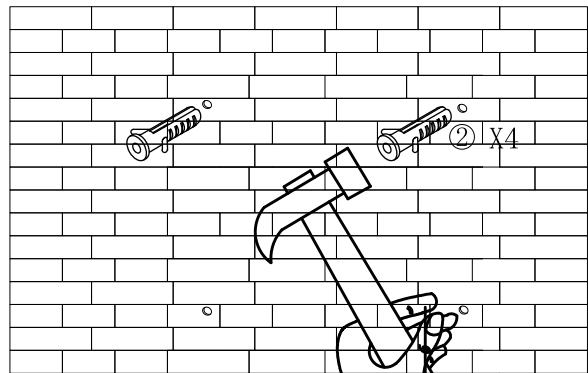

2

Step 2. Mark four (4) mounting holes on the wall corresponding to the pre-drilled hole locations in the mounting bars on the inside back panel of the cabinet.

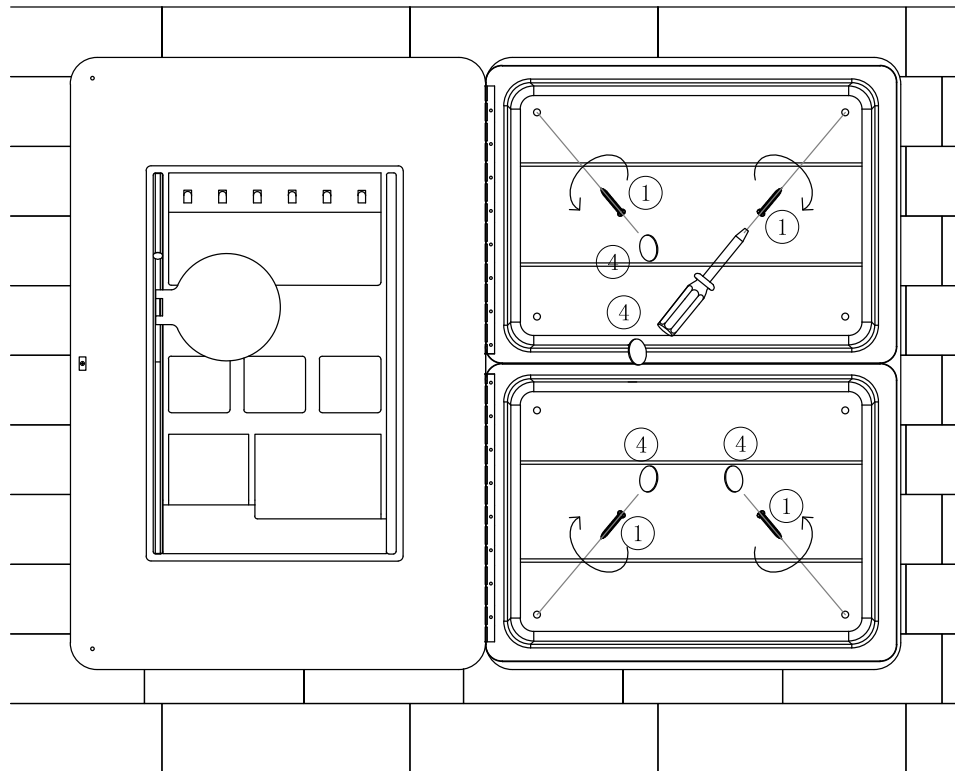

Step 3. With the assistance of a helper to hold the cabinet in place, drive the provided mounting screws to securely fasten the cabinet to the mounting surface.

05/Shelf Installation

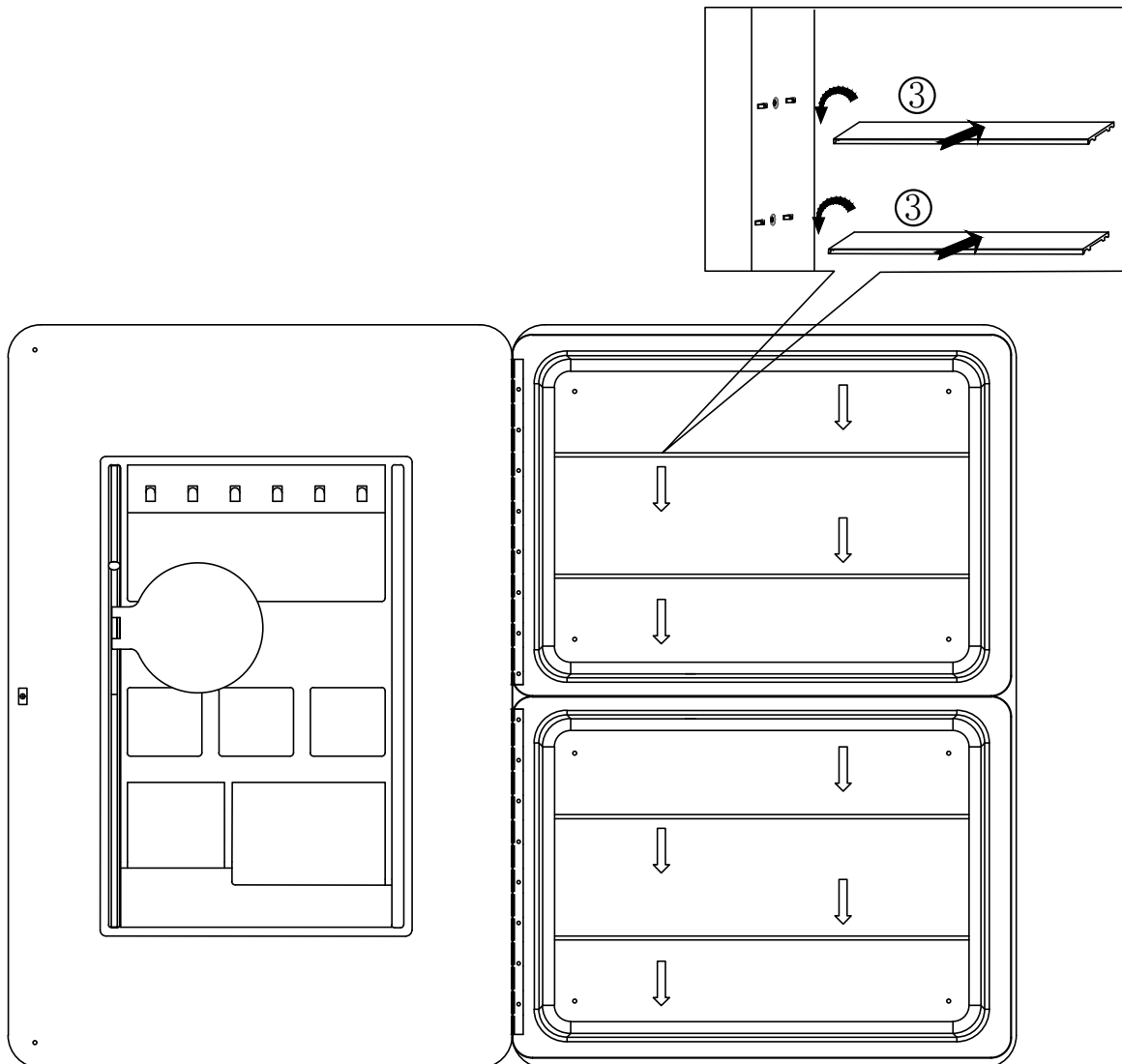

Step 1: Place the shelf inside the mirror cabinet.

Step 2: Align with the holes of the mirror cabinet and fasten it downward.

WARRANTY CARD

Your warranty includes

- **30 Days Money Back Guaranty**

Within the first 30 days of your purchase, you are allowed to return your product for a full refund.

- **30 Days to 3 Months(6 Months)**

We will replace the defective unit due to manufacturer fault with a new one. (You will receive extra 3 Months warranty if you register on our website.)

- **3 Months to 24 Months**

Within 24 Months, we will provide timely and effective online after-sales service after your purchase.

How to return your Products

- Contact with your order number.
- We will issue you RMA # and return address for your return.
- Please fill out RMA info, tear off this page and leave it inside your return package.
- We will issue replace / return after receiving your return.

Return product details

To get your returns processed as quickly as possible, please fill this form and include it in your return package.

Purchase Name	
Order Number	
Date of Purchase	
Your Email Address	
Where did you buy it	

MADE IN VIETNAM

