

# Assembly Instructions

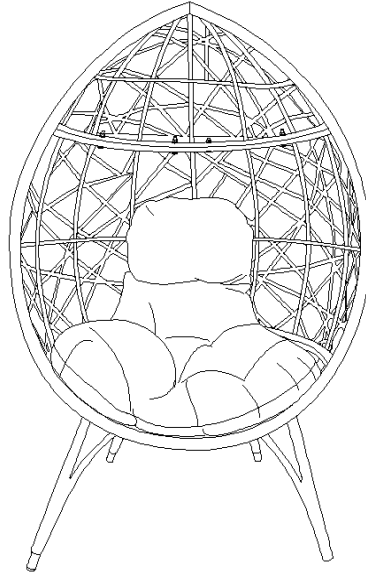



**Caution : Please read this carefully before you proceed**

## Swing Chair











### Parts List

Label	Picture	Description	QTY
A		Front Left Leg	1
B		Front Right Leg	1
C		Back Left Leg	1
D		Back Right Leg	1
E		Basket Seat	1

F		Middle Left Side Panel	1
G		Middle Right Side Panel	1
H		Basket Top	1
I		Cushion	1

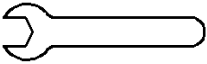
## Hardware

Label	Picture	Description	QTY
①		Bolt Plastic Cap	27
②		Nut Plastic Cap	15
③		Bolt M6*15mm	13
④		Bolt M6*35mm	15
⑤		Nut	15
⑥		Washer Ring	41
⑦		Wrench	1
⑧		Allen Key	1

# Assembly Preparation

Before Beginning Assembly:

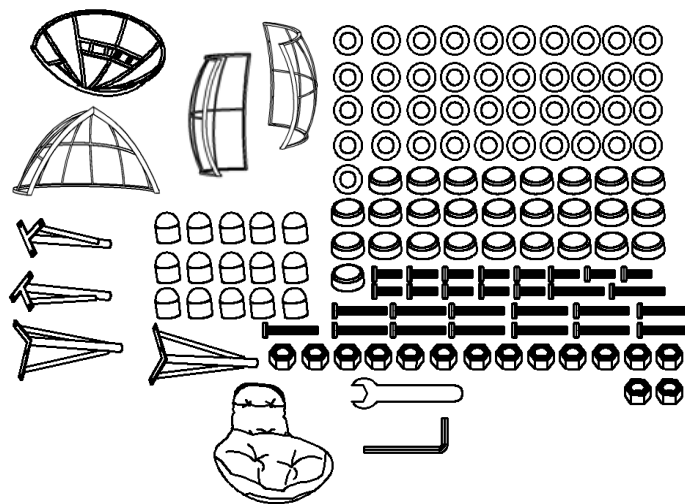

- Read instructions, cover to cover-



- Have 2 adults on hand for assembly-



- Do not assemble on flooring or carpet-



- Assemble on a clean non-marring surface (packing foam)-



- Save all packaging until finished-

# Assembly Steps

## Overview

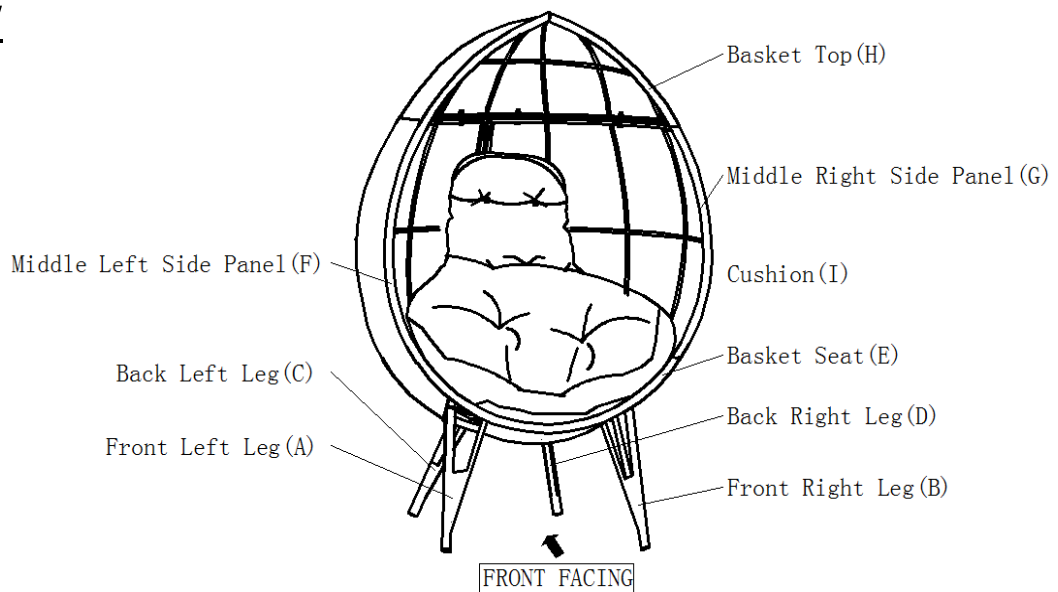

This Chair has multiple parts and may require up to 30 minutes to assemble. To give you an overview of the Chair parts, the above picture is provided to help you put the various parts into perspective. Please read through the instructions below to familiarise yourself with the parts and steps before assembly.

## Step 1

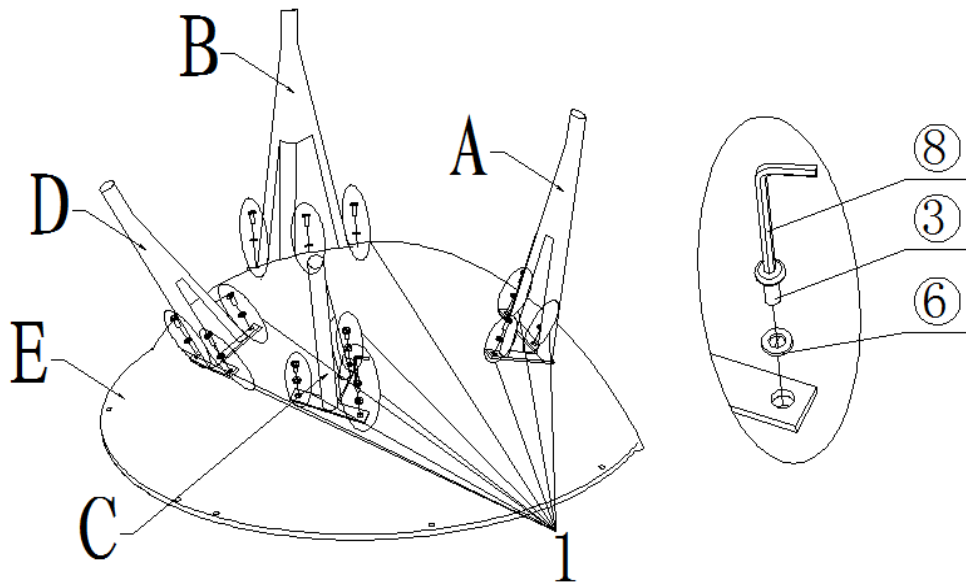

Open the carton and place all the parts onto a clean, soft surface.

Unpack all hardware packages.

Place the Basket Seat(E) with its Mounting Positions, facing upwards .

Attach Front Left Leg(A) to Basket Seat(E) with Allen Key(⑧), using Flat Washers (⑥) and Bolts (③)

Repeat the same process with Front Right Leg(B), Back Left Leg(C) and Back Right Leg(D)  
Do not fully tighten the Bolts.

## Step 2

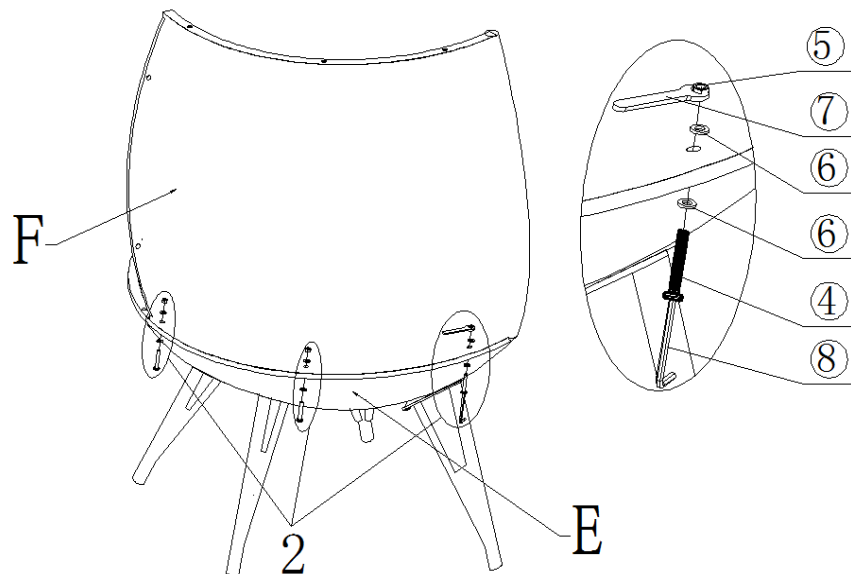

Stand the Basket Seat(E) upright.

Attach the Middle Left Side Panel(F) to the Basket Seat(E) with Allen Key(⑧) and Wrench (⑦), using Bolts(④), Washers(⑥) and Nuts (⑤).

Do not fully tighten the bolts.

Caution:Two or three adults are required for assembly at this step.

### Step 3

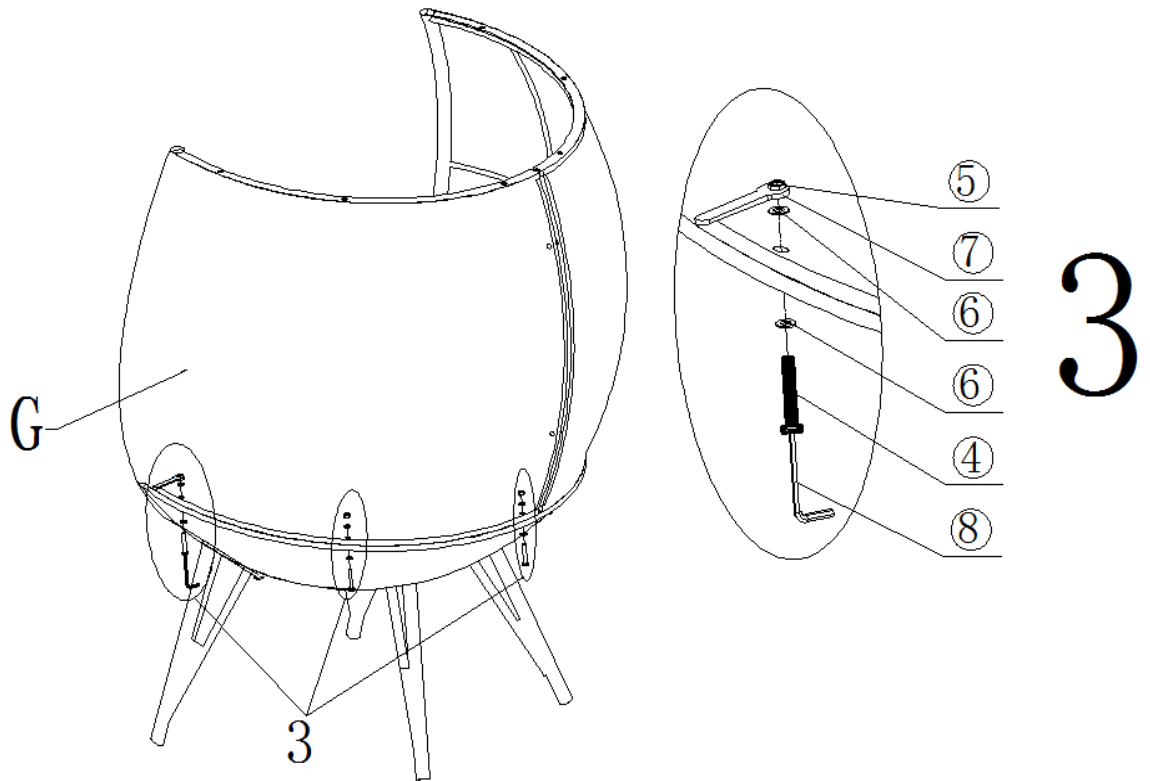

Attach the Middle Right Side Panel(G) to the Basket Seat(E) with the Allen Key(⑧) and Wrench (⑦), using Bolts (④), Washers(⑥) and Nuts (⑤) .

Do not fully tighten the bolts.

Caution:Two or three adults are required for assembly at this step.

### Step 4

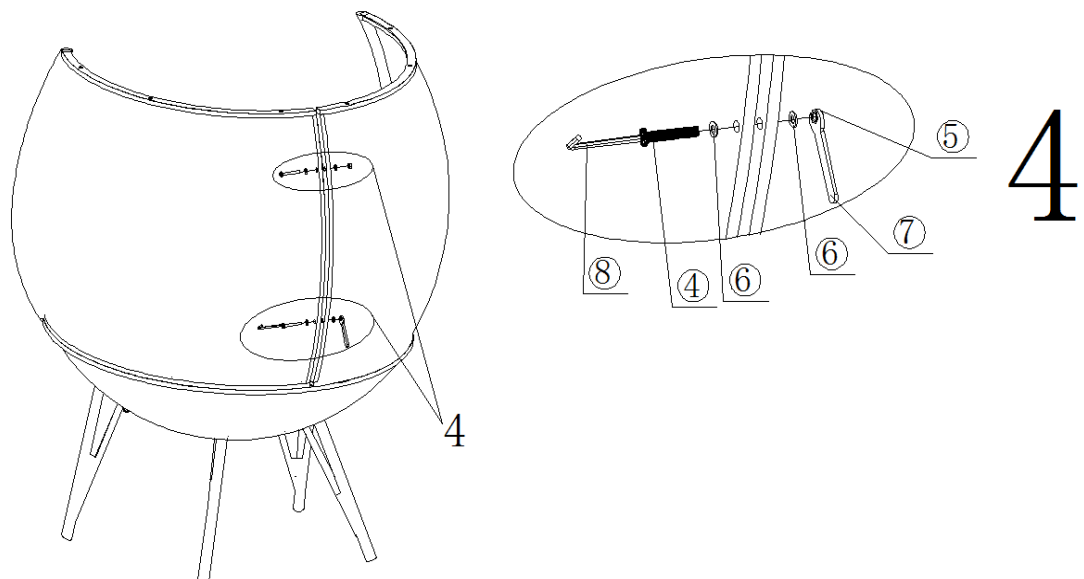

Attach the Middle Right Side Panel(G) to the Middle Left Side Panel(F) with the Allen Key(⑧) and Wrench (⑦), using Bolts (④), Washers(⑥) and Nuts (⑤) .

Do not fully tighten the bolts.

Caution:Two or three adults partners are required for assembly at this step.

## Step 5

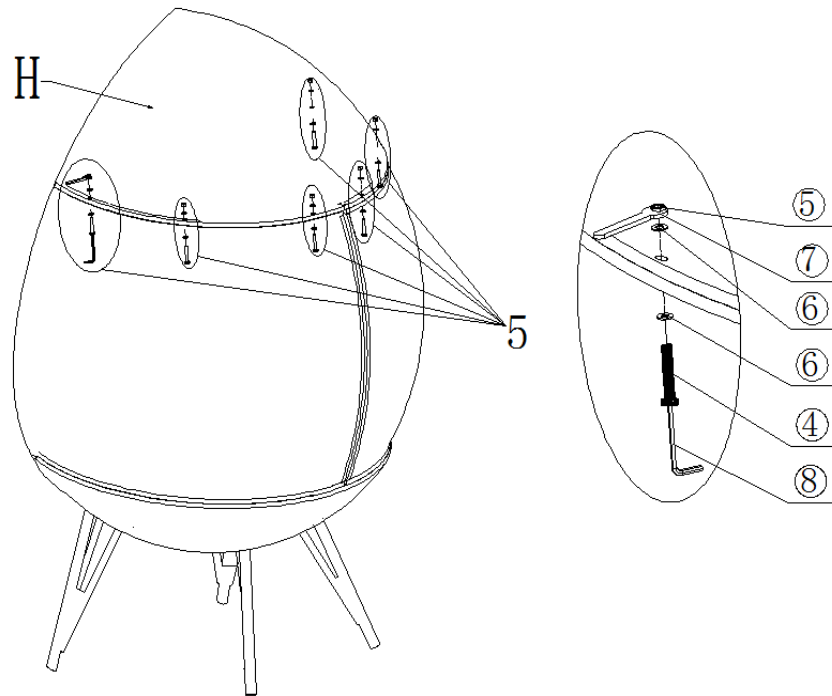

Attach the Basket Top(H) to the Middle Right Side Panel(G) and Middle Left Side Panel(F) with the Allen Key(⑧) and Wrench (⑦), using Bolts (④), Washers(⑥) and Nuts (⑤).

Do not fully tighten the bolts.

Caution: Two or three adults are required for assembly at this step.

## Step 6

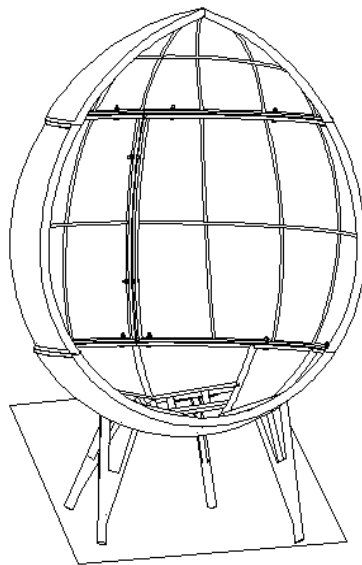

Check for stability and then tighten all Bolts at all joints.

Note: DO NOT fully tighten a Bolt in one go and then move on to the next.

Rather in a sequential manner, gradually tighten each Bolt until all Bolts are evenly secured.

This methodology will ensure maximum evenness once all Bolts are fully tightened.

## Step 7

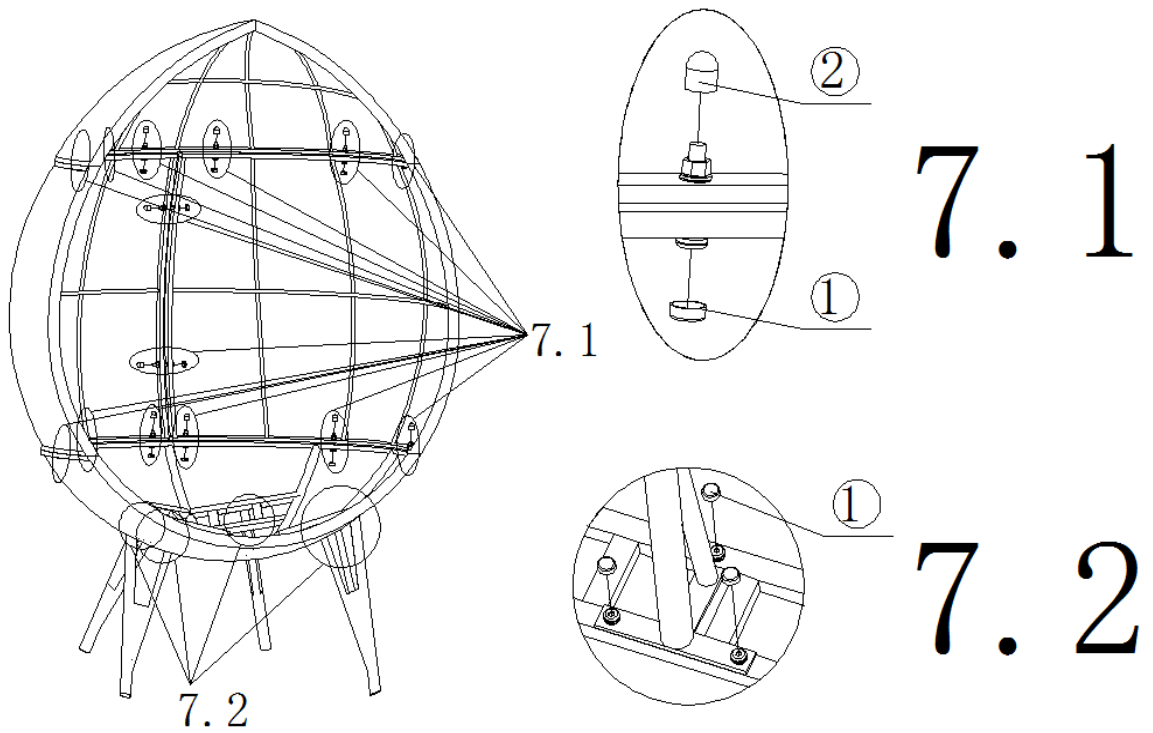





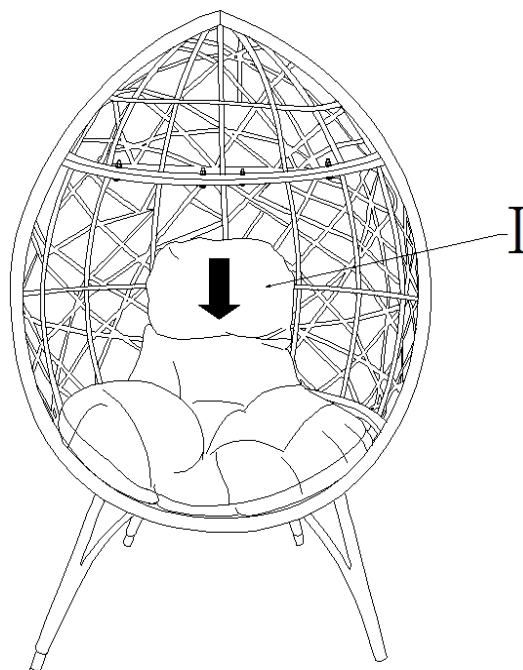















Cover all the Bolts with the Bolt Caps(①) and Bolt Caps(②) as picture 7.1 and 7.2 shows.

## Step 8



Place the Cushion(I) in the Basket.  
Your Basket Chair is ready for use.

## Care & Maintenance

-   ● Do not put hot items directly on furniture surface
  -   ● Do not clean furniture with harsh cleansers or polish.
  -   ● To obtain the longest lifespan of your outdoor products, minimizing exposure to direct sunlight is recommended.
  -   ● Children should not climb or jump on the furniture.
  -   ● Do not write on furniture without a padded barrier to protect the surface.
  -   ● To obtain the longest lifespan of your outdoor products, avoid extended and lengthy exposure to rain, snow, and direct sunshine. Whenever possible cover the product and /or place under patio or awnings.
  -   ● Not for commercial use. For residential use only .
  -   ● Stains may be removed with mild soap solution and damp cloth.
  -   ● Keep away from sources of ignition.
- 
-   ● Dust and pick-up spills using a clean, non-colored, lint-free cloth .