

---

## **INSTALLATION INSTRUCTIONS**

---

MANUFACTURING QUALITY  
CEILING FANS SINCE FOREVER.

## SAFETY PRECAUTIONS

---

- Before you begin installing the fan, shut power off at the circuit breaker of the fuse box.
- Make sure that all electrical connections are in accordance with National Electrical Code, ANSI/NFPA 70 and local codes. Hire a licensed electrician if you are unfamiliar with installing electrical wiring.
- Make sure the installation site you choose allows the fan blades to rotate without any obstructions. Allow a minimum clearance of 2.1m (7 feet) from the floor and 18 inches from the tip of the blades to the wall.
- The outlet box and support structure must be securely mounted and capable of reliably supporting a minimum of 35 pounds. Use only U.L. listed outlet boxes marked "Acceptable for Fan Support of 15.9 kg (35 lbs) or less".
- Before and after you install the fan, make sure that all mounting components are secured to prevent the fan from falling.
- Do not insert anything into the fan blades while the fan is operating.
- To change the direction of the rotation of the blades, the fan must be in operation mode.
- All set screws must be checked and retightened where necessary before installation.
- After making the wire connections, the wires should be spread apart with the grounded conductor and the equipment-grounding conductor on one side of the outlet box and the ungrounded conductor on the other side of the outlet box.
- The splices after being made should be turned upward and pushed carefully up into the outlet box. Conductor wiring identified as grounded is to be connected to a grounded conductor of power supply. Conductor wiring identified as ungrounded conductor is to be connected to an ungrounded conductor. Conductor wiring identified for equipment grounding is to be connected to an equipment-grounding conductor.
- This device complies with part 15 of the FCC Rules. Operation is subject to the following two conditions: (1) This device may not cause harmful interference, and (2) this device must accept any interference received, including interference that may cause undesired operation.
- This product is suitable for use in damp locations.

## SAFETY PRECAUTIONS

---

- **CAUTION:** Read all instructions and safety information before installing your new fan. Review accompanying assembly diagrams.
- **WARNING:** To reduce the risk of fire, electric shock, or personal injury, mount to outlet box marked "Acceptable for Fan Support of 15.9 kg (35 lbs) or less" and use mounting screws provided with the outlet box.
- **CAUTION:** To reduce the risk of injury, use only the screws provided with the outlet box in conjunction with the lock washers.
- **WARNING:** To reduce the risk of personal injury, do not bend the blade bracket when installing the brackets, balancing the blades, or cleaning the fan. Do not insert foreign objects in between rotating fan blades.
- **CAUTION:** To reduce the risk of electric shock, disconnect the electrical supply circuit to the fan before installing the light kit.
- **WARNING:** To reduce the risk of fire or electric shock, this fan must be installed with a general use, non-dimmable, single gang, isolating wall control/switch.
- **WARNING:** To reduce the risk of fire or electric shock, do not use this fan with any solid-state speed control device.  
  
**NOTE:** The important safeguards and instructions appearing in this manual are not meant to cover all possible conditions and situations that may occur. It must be understood that common sense, caution and care are factors which cannot be built into this product. These factors must be supplied by the person (s) installing, caring for and operating the unit.
- **CAUTION:** The light source is designed for this specific application and can overheat if serviced by untrained personnel. If any servicing is required, the product should be returned to an authorized service facility for examination or repair.
- **WARNING:** Do not use corrosive detergents for cleaning.

## Fan Diagram

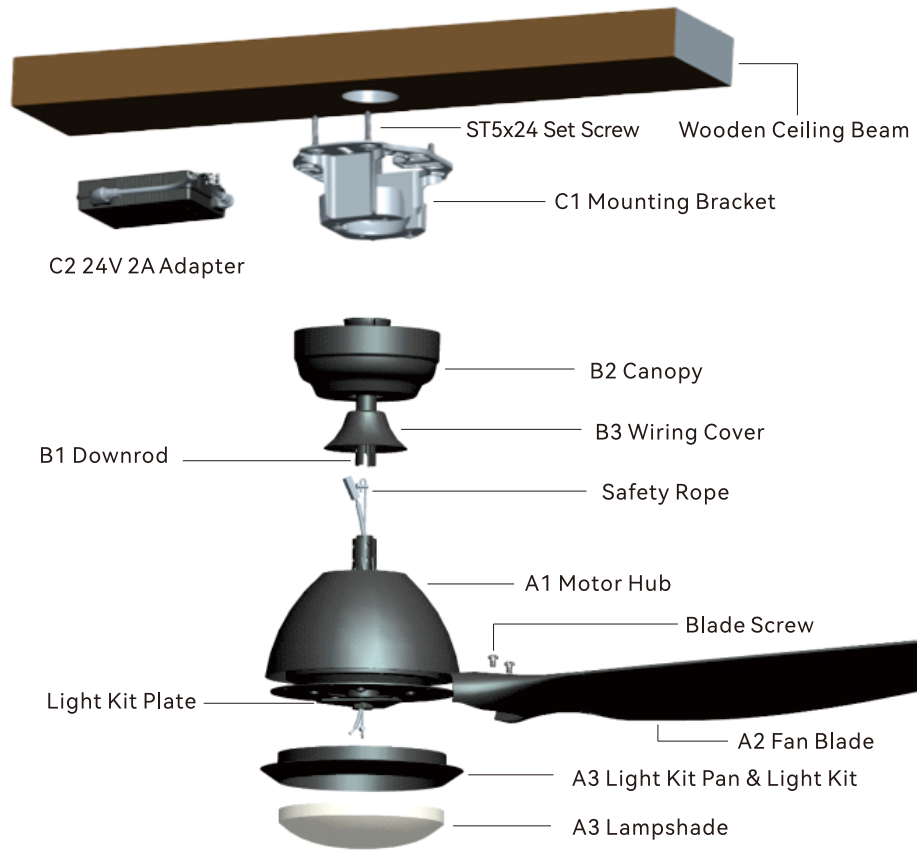

## Table of Contents

08	Disassembly of Motor
09	Fan Blades
10	Motor Hub
11	Light Kit Pan & Light Kit
12	Downrod
13	Mounting Bracket
14	Hanging
15	Wiring
16	Canopy
17	Lampshade / Power On
18	Remote Control
19	Carro Home App
20	Smart Devices
21	Troubleshooting
22	Care & Cleaning / FCC

## Tools & Materials Required



External hexagonal wrench



Phillips screwdriver



Step ladder

## Package Contents

CARRO

Before installing, please check to make sure you have received all the necessary components for installation.

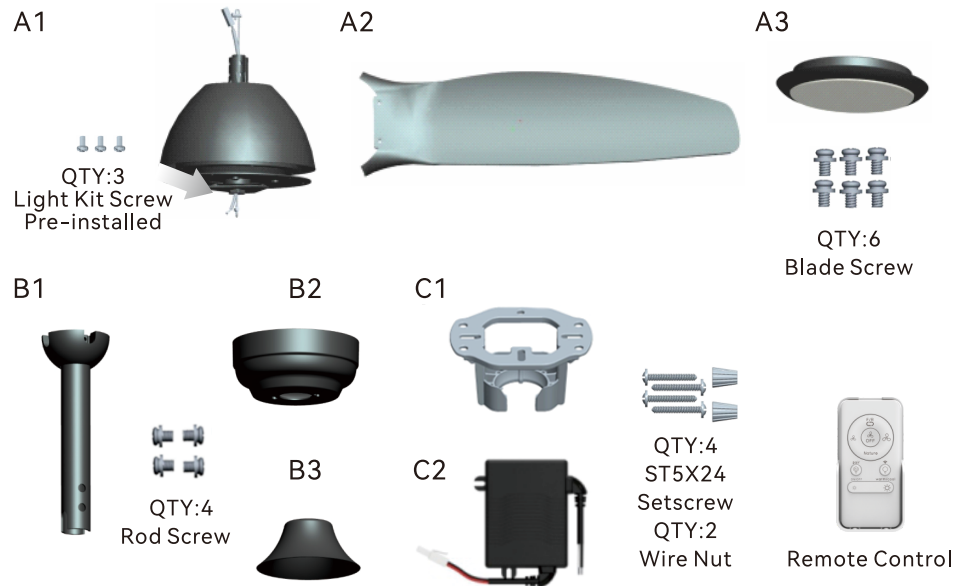

## Installation

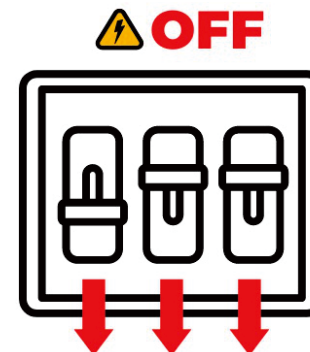

**WARNING:** To avoid serious injury or death, turn off the power at the circuit breaker before installing the fan.

### 1. Disassemble the Motor

1.1 Take out the motor hub and remove the fixed screw of the motor hub shell as shown in Fig 1.1. Save the screw for later use.

1.2 Take off the shell of the motor hub as shown in Fig 1.2 below.



Fig 1.1



Fig 1.2

# Installation: Fan Blades

## 2. Install the Fan Blades

2.1 Locate 6 blade attachment screws in the hardware pack. Make sure each blade matches the corresponding place of the motor hub and tighten with the screws as shown in Fig 2.1.

2.2 Three blades installed as shown in Fig 2.2.



Fig 2.1

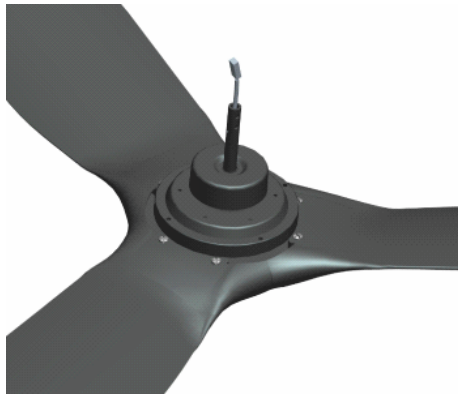

Fig 2.2

# Installation

## 3. Reinstall the Motor Hub Shell

3.1 As shown in the Fig 3.1, put back the dismantled motor hub shell and align the screw holes.

3.2 Then fasten the shell to the motor hub with the screw taken previously in step 1.

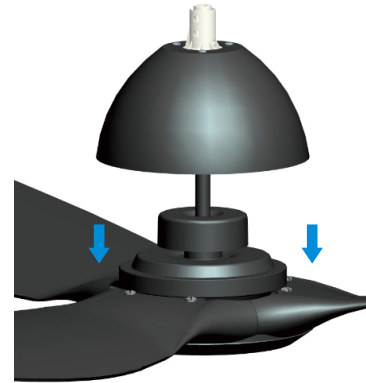

Fig 3.1

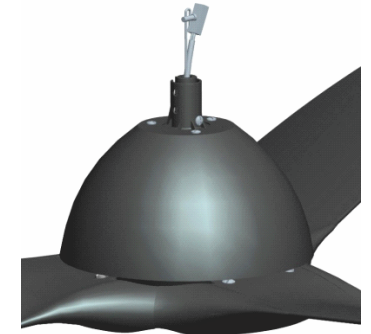

Fig 3.2

## 4. Disassemble the Light Set

4.1 Remove the light set out of the box and turn the lampshade counterclockwise to disassemble it, and then remove the LED light kit out of the light kit pan directly as the light kit is fixed by magnetic attraction.

4.2 The light set after disassembly is shown in Fig 4.2.

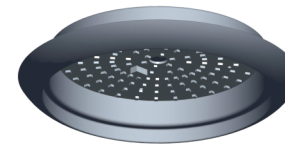

Fig 4.1

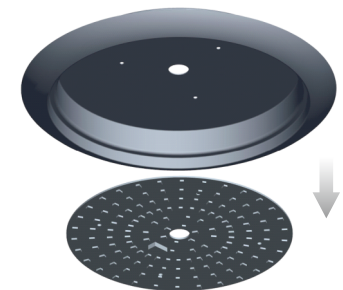

Fig 4.2

## Installation: Light Kit Pan & Light Kit

### 5. Install the Light Kit Pan & Light Kit

5.1 Remove three screws from the the light kit plate of the motor housing.

5.2 Feed the light pin wire and safety rope through center hole of the light kit pan. Attach the light kit pan to the light kit plate of the motor housing. Reinstall the screws that were removed. Make sure all the screws are firmly tightened.

5.3 Allow the light pin wire and safety rope to come through the light kit. Reinstall the light kit. The light kit is magnetically attracted to the pan with the help of magnets. Insert the light wire connector plug to the light kit terminal block.

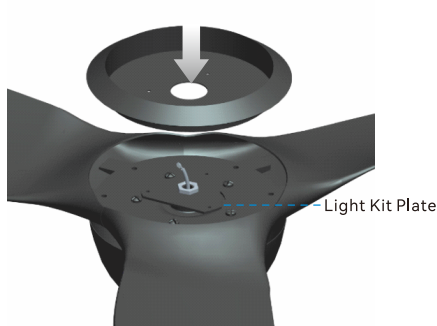

Fig 5.1

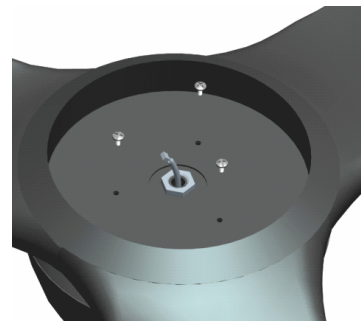

Fig 5.2

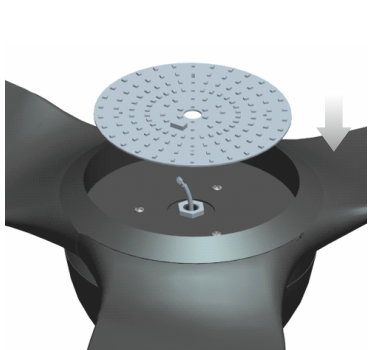

Fig 5.3

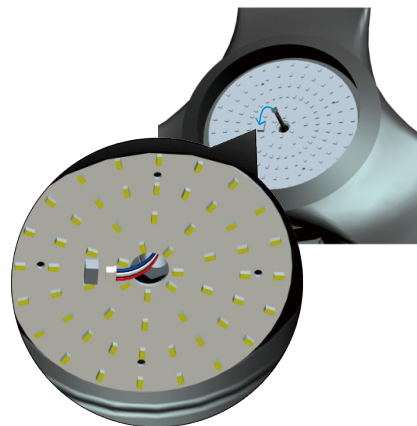

Fig 5.4

## Installation: Downrod

### 6. Attach the Downrod

6.1 Assemble downrod as shown in Fig 6.1.

Insert the downrod through the canopy and wiring cover.



Fig 6.1

6.2 Feed the motor pin wire and safety rope through the downrod. Install four downrod screws (in the screw package), securely tightening down to ensure proper connection as shown in Fig 6.2.1 & 6.2.2.

Slide the wiring cover down until it rests on top of the housing as shown in Fig 6.2.3.

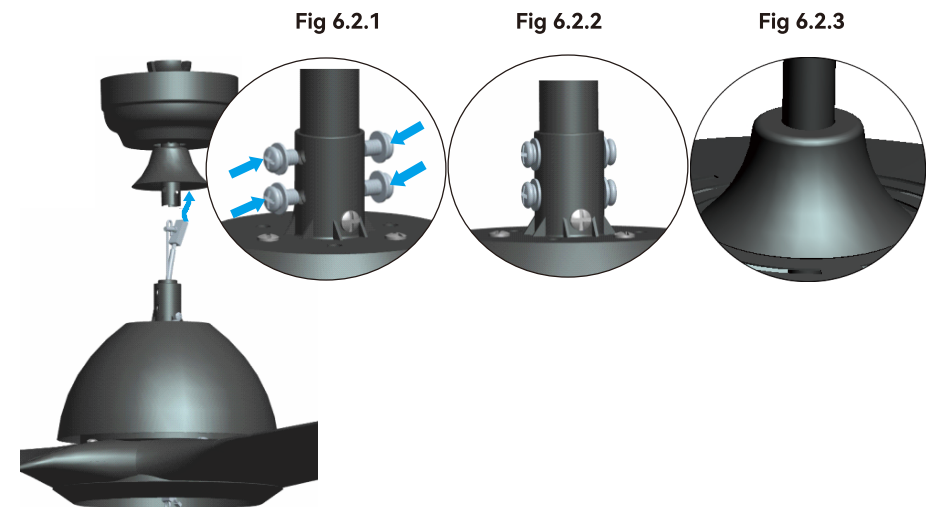

## Installation: Mounting Bracket

### 7. Install the Mounting Bracket

Install the mounting bracket to the ceiling box, as shown in Fig 7.1 below. Rotate the mounting bracket in different directions so that the bracket mounting holes match the screw holes of the ceiling box.

**Note:** This mounting bracket is a standard cable box. If the mounting bracket is installed at the outlet box, it should be installed on the outlet box with two screws matching the outlet box itself, as shown in Fig 7.1.

**WARNING:** DO NOT use plastic outlet box. Use only U.L.listed outlet boxes marked "Acceptable for Fan Support of 15.9 kg (35 lbs ) or less".

This bracket can also be mounted to the wooden ceiling beam, and then the four ST5x24 screws can be used to lock the corresponding holes on the left and right sides of the bracket.

**Note:** The wooden ceiling beam must meet the tensile test of 30KG for installation, as shown in Fig 7.2. It is also possible to install the mounting bracket directly to the concrete ceiling and install four screws (not included) to the left and right corresponding holes of the bracket to lock the ceiling.

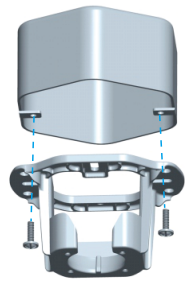

Fig 7.1

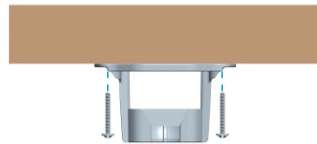

Fig 7.2

If you have an angled or vaulted ceiling (Fig 7.3)

1. When installing the mounting bracket, the bracket groove is upward.
2. You will need a longer downrod.
3. The maximum angle is 27 degree.



Fig 7.3

## Installation: Hanging

### 8. Hang Ceiling Fan & Install Power Adapter & Wire the Fan

**WARNING:** To reduce the risk of fire, electric shock or other personal injury, mount the fan only to an outlet box or supporting system marked acceptable for fan support and use the mounting screws provided with the outlet box.

**WARNING:** Check to see that all connections are tight, including ground, and there are no visible bare wires at the wire nuts (except for the ground wire).

**WARNING:** To reduce the risk of fire or electric shock, do not use this fan with any solid-state speed control device.

**WARNING:** To avoid any electrical shock, be sure electricity is turned off at the main fuse box before wiring.

Install the ball end of the downrod into the opening of mounting bracket. Rotate the downrod until the tab in the mounting bracket is seated in the slot in the downrod ball as shown in the enlarged image of Fig 8.1.

**WARNING:** The fan and/or downrod should not rotate in the mounting bracket, if installed correctly. Failure to align the slot in the downrod ball with the tab on the mounting bracket may result in fan falling causing serious injury or death.

Attach the other end of safety cable to a safe place.

**Note:** Installing the ceiling fan with a safety cable is an extra safety feature. It secures the fan to the ceiling hook or safe place and avoids the fan from falling even in the case of material failure.

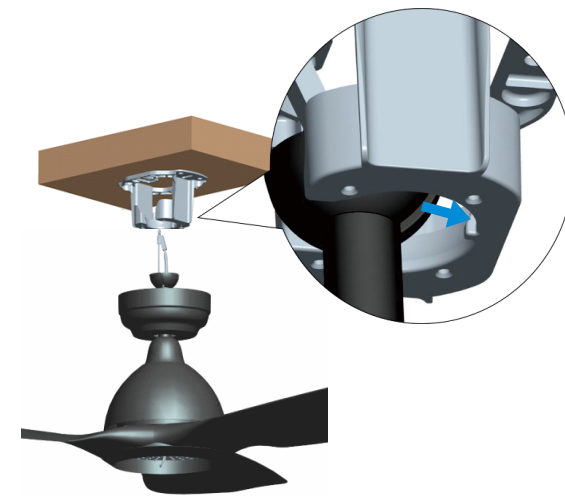

Fig 8.1

## Installation: Wiring

Slide the Adapter inside the bracket and connect the DC output wire connector plug of the adapter with the motor pin wire connector which through the downrod as shown in Fig 8.3. Make sure all wires are tucked in the canopy. Connect the input wires of the adapter to the supply wires.

**Important:** After the connections have been made, the connected wires should be turned upward and pushed carefully up into the outlet box.

**Note:** Slide the adapter horizontally into the bracket in the direction of the arrow shown in Fig 8.2 below, and the flat side facing the ceiling. Note that the upper patterns of the mounting bracket correspond to the two sides of the adapter's push-in.

**Note:** DO NOT stand upright (as shown in Fig 8.4) or place the adapter incorrectly (as shown in Fig 8.5) otherwise the adapter cannot be inserted into the bracket, which will affect the wiring.

**Note:** The Green/Yellow wire from bracket connects with the supply Ground wire using the wire nut. Connect the White wire of the Adapter to the supply White (Neutral) wire using a wire nut, connect the Black wire of the Adapter to the supply Black/Red (Hot/Live) wire using a wire nut. Then hide them inside the ceiling. (Make sure all the wires are connected to the correct colors as shown in Fig 8.3)

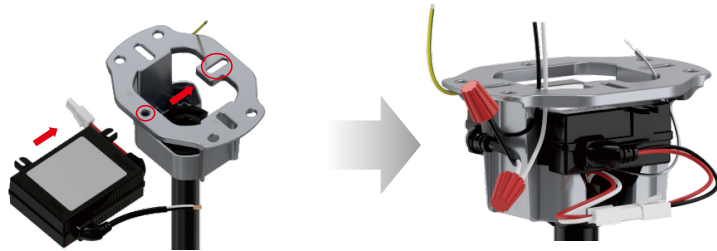

Fig 8.2

Fig 8.3

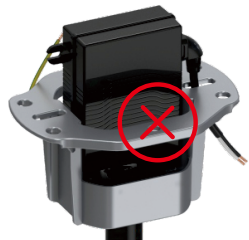

Fig 8.4

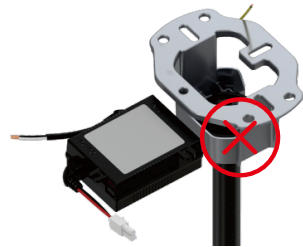

Fig 8.5

## Installation: Canopy

### 9. Install the Canopy

There are two kinds of canopies and two ways to install. You may receive one of them. Please follow below instructions before installation.

A: The screws of mounting bracket are exposed.

Make sure all wires are tucked in the canopy. Raise the canopy to the mounting bracket, align the hole slots in the canopy with the two mounting bracket screws, then turn the canopy in the direction of the arrow in Fig A until the mounting brackets screws engage from the bigger slots of the canopy to the smaller ones. Then secure the canopy to the mounting bracket with the screws.

B: There is no screw on the mounting bracket.

Make sure all wires are tucked in the canopy. Raise the canopy to the mounting bracket, align the two notches inside the canopy with the two tabs on the mounting bracket. Attach the canopy by lifting and turning clockwise until it stops.

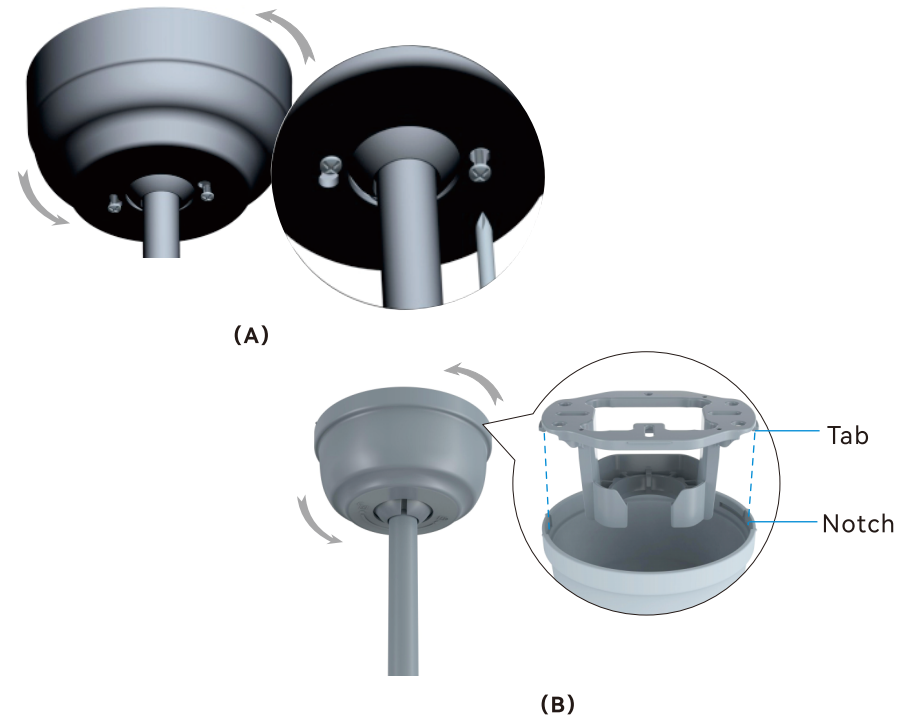

# Installation: Lampshade & Power on

## 10. Install the Lampshade

Align the lampshade slot with the slot of light kit pan, and turn it clockwise to securely lock into the light kit pan as shown in Fig 10.1.

The lampshade installed as shown in Fig 10.2.

**WARNING:** To prevent SERIOUS INJURY or DEATH, make sure that lampshade is properly secured. Allow the lampshade to cool completely before removing.

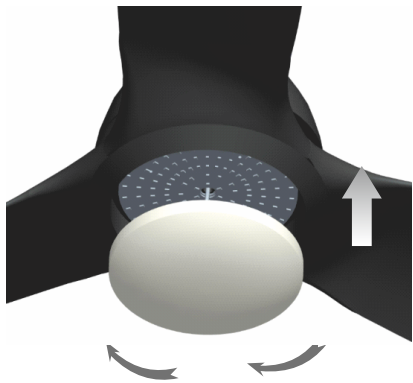

Fig 10.1

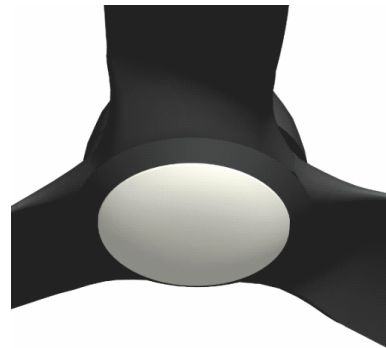



Fig 10.2

At this time, the ceiling fan has been installed. Turn on the power supply from the breaker circuit of the main switch or the room where the ceiling fan is installed. After the power is on, observe whether the fan light is on.



# Remote Control Instructions

## Pair the Remote Control to Your Fan

Power on the fan and pair the remote to the fan within 1 min. To pair remote to fan, press and hold  button for 3-5 secs to pair remote to the fan. Successful pairing will trigger the fan light off.

## Remote Control Button Definitions



Turns the fan off.



Switches between summer mode and winter mode.

· Summer mode - (Counter-clockwise)

A downward airflow creates a cooling effect.

· Winter mode - (Clockwise)

An upward airflow moves warm air away from the ceiling area and redistributes it around the living space.



Turns the fan on and decreases fan speed.



Turns the fan on and increases fan speed.

Nature

Switches the fan speed between nature mode and normal mode. Simulates a natural breeze, gentle enough not to disturb while you sleep.



Turns the lights on or off and RF pairing.

**Note:** Power on the fan and pair the remote to the fan within 1 min. To pair remote to fan, press and hold  button for 3-5 secs to pair remote to the fan. Successful pairing will trigger the fan light off.



Switches between warm light and cool light. WIFI Troubleshooting.

**Note:** Press/hold button for 5 sec. The fan will switch to AP Mode, then select AP Mode on APP, follow the APP control instructions and enable fan Wi-Fi.



Press/Hold button to decrease the light intensity.



Press/Hold to button to increase the light intensity.

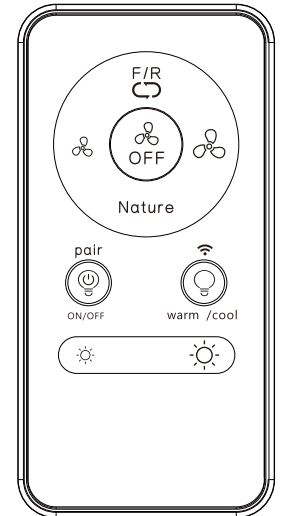

**WARNING:** Do not expose the remote control to direct contact with water.

# Troubleshooting

Try these troubleshooting steps before contacting Customer Service. For additional operation, maintenance, and troubleshooting information, please contact our customer service center.

SYMPTOM	POSSIBLE SOLUTION
Fan not spinning	<p>① Make sure the fan is getting power. ② Check your circuit breaker or fuse panel and wall switch for functionality. ③ Check to make sure the fan wires are correctly connected to the house wires. ④ Remote control must be paired with the fan within 1 minute after connecting the fan to the electricity. ⑤ If you have paired the app but the fan still does not work (light and fan both didn't work) or couldn't pair the app to the fan, try to reset the fan: to reset the fan, cut the power for 10 minutes, then turn the power on and press the pairing button  on the remote for 3-5 seconds until the fan light turns off, then pair the Carro Home App again. ⑥ Use a multi-meter and test the adapter wiring harness to see if there is any electrical output. ⑦ All the pin wiring on the circuit board must be inserted tight and in the correct position. ⑧ Remote needs to be paired with the fan first. ⑨ Make sure the fan blades spin freely. ⑩ If you're using a wall control, check the power to the breaker from your control and try working your ceiling fan manually. (Normal switch only for the fan power on/off)</p>
Fan light not working	<p>① Make sure LED wires are connected to the circuit board. ② Make sure the whole fan is powered.</p>
The fan is noisy and wobbling	<p>① Check if the blade screws are NOT rubbing against any part of the motor housing. ② Check the pin wires are NOT connected against any moving parts. ③ Check the down fan cup is NOT hitting the motor. ④ Confirm the canopy is NOT touching the ceiling while the fan is in operation. ⑤ Check the down rod is NOT slanted. ⑥ Tighten any loose screws on the light kit, fan blades, motor coupling, down rod, brackets and mounting hardware. ⑦ Confirm the hanger ball is firmly seated in the mounting bracket. ⑧ The ceiling beam must meet the minimum tensile test strength of 30KG for installation. ⑨ Make sure the blades and brackets are NOT bent or deformed. ⑩ Verify the wire connections are not rattling against each other. ⑪ Verify the fan blades are not cracked. If the fan blades are cracked, replace the damaged blades with a new blade set from the same brand as your ceiling fan to ensure compatibility. ⑫ Confirm the light kit is NOT slanting and hitting the motor.</p>
Unable to pair remote and app	<p>① Check if the wires are connected in the correct position or not. ② Check the batteries in the remote. ③ Disconnect the power for 10 minutes, reconnect the power and pair the remote with the fan immediately, within 1 minute. Also try pairing the app to reconnect. ④ The WiFi must be 2.4Ghz, incompatible with 5Ghz WiFi or combined with 5Ghz. ⑤ App must be the newest version. ⑥ Connect with correct app "Carro Home".</p>
Fan or light turning on or off by themselves	<p>① Confirm the circuit breaker is not malfunctioning. ② Verify the wire connections are not frayed. ③ Check the app is not set to a timer or schedule. ④ Cut the fan power for 10 minutes then power on again. ⑤ All the pin wiring on the circuit board must be inserted tight and in the correct position.</p>

# Care & Cleaning

- 1 Check the support connections, brackets, and blade attachments twice a year. Make sure they are secure. Because of the fan's natural movement, some connections may become loose over time. It is not necessary to remove the fan from the ceiling.
2. Clean your fan periodically. Use only a soft brush or lint-free cloth to avoid scratching the finish. The plating is sealed with a lacquer to minimize discoloration or tarnishing.
3. (Optional) Apply a light coat of furniture polish to the wood blades.
4. (Optional) Cover small scratches with a light application of shoe polish.

### DO NOT:

1. Use water when cleaning. Water could damage the motor, or the wood, or possibly cause an electrical shock.
2. Apply oil to your fan or motor. The motor has permanently lubricated sealed ball bearings.

**WARNING:** Power off the fan before performing maintenance or cleaning the fan.

# FCC Statement

**Note:** This equipment has been tested and found to comply with the limits for a Class B digital device, pursuant to part 15 of the FCC Rules. These limits are designed to provide reasonable protection against harmful interference in a residential installation. This equipment generates, uses and can radiate radio frequency energy and, if not installed and used in accordance with the instructions, may cause harmful interference to radio communications. However, there is no guarantee that interference will not occur in a particular installation. If this equipment does cause harmful interference to radio or television reception, which can be determined by turning the equipment off and on, the user is encouraged to try to correct the interference by one or more of the following measures:

- Reorient or relocate the receiving antenna.
- Increase the separation between the equipment and receiver.
- Connect the equipment into an outlet on a circuit different from that to which the receiver is connected.
- Consult the dealer or an experienced radio/TV technician for help.

**WARNING:** Changes or modifications to this unit not expressly approved by the party responsible for compliance could void the user's authority to operate the equipment.